

Traffic Impact Report

Longs Drugs Aina Haina



Prepared for:
Architects Hawaii Ltd.

Prepared by:
Wilson Okamoto Corporation

December 2014

TRAFFIC IMPACT REPORT

FOR

LONGS DRUGS AINA HAINA

Prepared for:

Architects Hawaii Ltd.
733 Bishop Street, Suite 3100
Honolulu, HI 96813

Prepared by:

Wilson Okamoto Corporation
1907 S. Beretania Street, Suite 400
Honolulu, Hawaii 96826
WOC Ref #10054-02

December 2014

TABLE OF CONTENTS

	Page
I. Introduction	1
A. Purpose of Study	1
B. Scope of Study	1
II. Project Description	1
A. Location	1
B. Project Characteristics	3
III. Existing Traffic Conditions.....	3
A. Area Roadway System	3
B. Traffic Volumes and Conditions.....	7
1. General.....	7
a. Field Investigation	7
b. Capacity Analysis Methodology.....	7
2. Existing Peak Hour Traffic	8
a. General.....	8
b. Kalaniana'ole Highway and Wailupe Circle.....	8
c. Kalaniana'ole Highway and West Hind Drive.....	11
d. West Hind Drive and Church/Shopping Center Driveways	12
e. West Hind Drive and School/Shopping Center Driveways.....	13
f. West Hind Drive and Makalena Street	13
g. West Hind Drive and Nenu'e Street.....	14
h. Kalaniana'ole Highway and Nenu'e Street.....	14
IV. Projected Traffic Conditions	15
A. General.....	15
B. Site-Generated Traffic.....	16
1. Trip Generation Methodology	16
2. Trip Distribution	17
a. General	17
b. Alternative 1	17
c. Alternative 2	24
d. Alternative 3	25
C. Through-Traffic Forecasting Methodology.....	25
D. Total Traffic Volumes Without Project	26
E. Total Traffic Volumes With Project.....	29

TABLE OF CONTENTS (CONT'D)

	Page
V. Traffic Impact Analysis	29
A. Alternative 1	29
B. Alternative 2	37
C. Alternative 3	38
VI. Recommendations	40
VII. Conclusion	41

LIST OF FIGURES

FIGURE 1	Location Map and Vicinity Map
FIGURE 2	Project Site Plan
FIGURE 3	Existing AM Peak Period of Traffic
FIGURE 4	Existing PM Peak Period of Traffic
FIGURE 5	Year 2015 AM Distribution of Site-Generated Vehicles With Alternative 1
FIGURE 6	Year 2015 PM Distribution of Site-Generated Vehicles With Alternative 1
FIGURE 7	Year 2015 AM Distribution of Site-Generated Vehicles With Alternative 2
FIGURE 8	Year 2015 PM Distribution of Site-Generated Vehicles With Alternative 2
FIGURE 9	Year 2015 AM Distribution of Site-Generated Vehicles With Alternative 3
FIGURE 10	Year 2015 PM Distribution of Site-Generated Vehicles With Alternative 3
FIGURE 11	Year 2015 AM Peak Period of Traffic Without Project
FIGURE 12	Year 2015 PM Peak Period of Traffic Without Project
FIGURE 13	Year 2015 AM Peak Period of Traffic With Alternative 1
FIGURE 14	Year 2015 PM Peak Period of Traffic With Alternative 1
FIGURE 15	Year 2015 AM Peak Period of Traffic With Alternative 2
FIGURE 16	Year 2015 PM Peak Period of Traffic With Alternative 2
FIGURE 17	Year 2015 AM Peak Period of Traffic With Alternative 3
FIGURE 18	Year 2015 PM Peak Period of Traffic With Alternative 3

LIST OF APPENDICIES

APPENDIX A	Existing Traffic Count Data
APPENDIX B	Level of Service Definitions
APPENDIX C	Capacity Analysis Calculations Existing Peak Period Traffic Analysis
APPENDIX D	Capacity Analysis Calculations Year 2015 Peak Period Traffic Analysis Without Project
APPENDIX E	Capacity Analysis Calculations Year 2015 Peak Period Traffic Analysis With Alternative 1
APPENDIX F	Capacity Analysis Calculations Year 2015 Peak Period Traffic Analysis With Alternative 2
APPENDIX G	Capacity Analysis Calculations Year 2015 Peak Period Traffic Analysis With Alternative 3

I. INTRODUCTION

A. Purpose of Study

The purpose of this study is to identify and assess the traffic impacts resulting from the development of a Longs Drugs store in Aina Haina on the island of Oahu. The proposed project entails the development of a new store which will include general merchandise and pharmacy services.

B. Scope of Study

This report presents the findings and conclusions of the traffic study, the scope of which includes:

1. Description of the proposed project.
2. Evaluation of existing roadway and traffic operations in the vicinity.
3. Analysis of future roadway and traffic conditions without the proposed project.
4. Analysis and development of trip generation characteristics for the proposed project.
5. Superimposing site-generated traffic over future traffic conditions.
6. The identification and analysis of traffic impacts resulting from the proposed project.
7. Recommendations of improvements, if appropriate, that would mitigate the traffic impacts resulting from the proposed project.

II. PROJECT DESCRIPTION

A. Location

The project site for the proposed Longs Drugs Aina Haina store is located adjacent to Kalaniana'ole Highway west of West Hind Drive in Aina Haina on the island of Oahu (see Figure 1). The project site is bounded by West Hind Drive to the east, Aina Haina Elementary school and a Hawaiian Telcom substation to the north, residential uses to the west, and Kalaniana'ole Highway to the south. The project site is further identified as Tax Map Keys (TMKs): 3-6-011: por. 001.

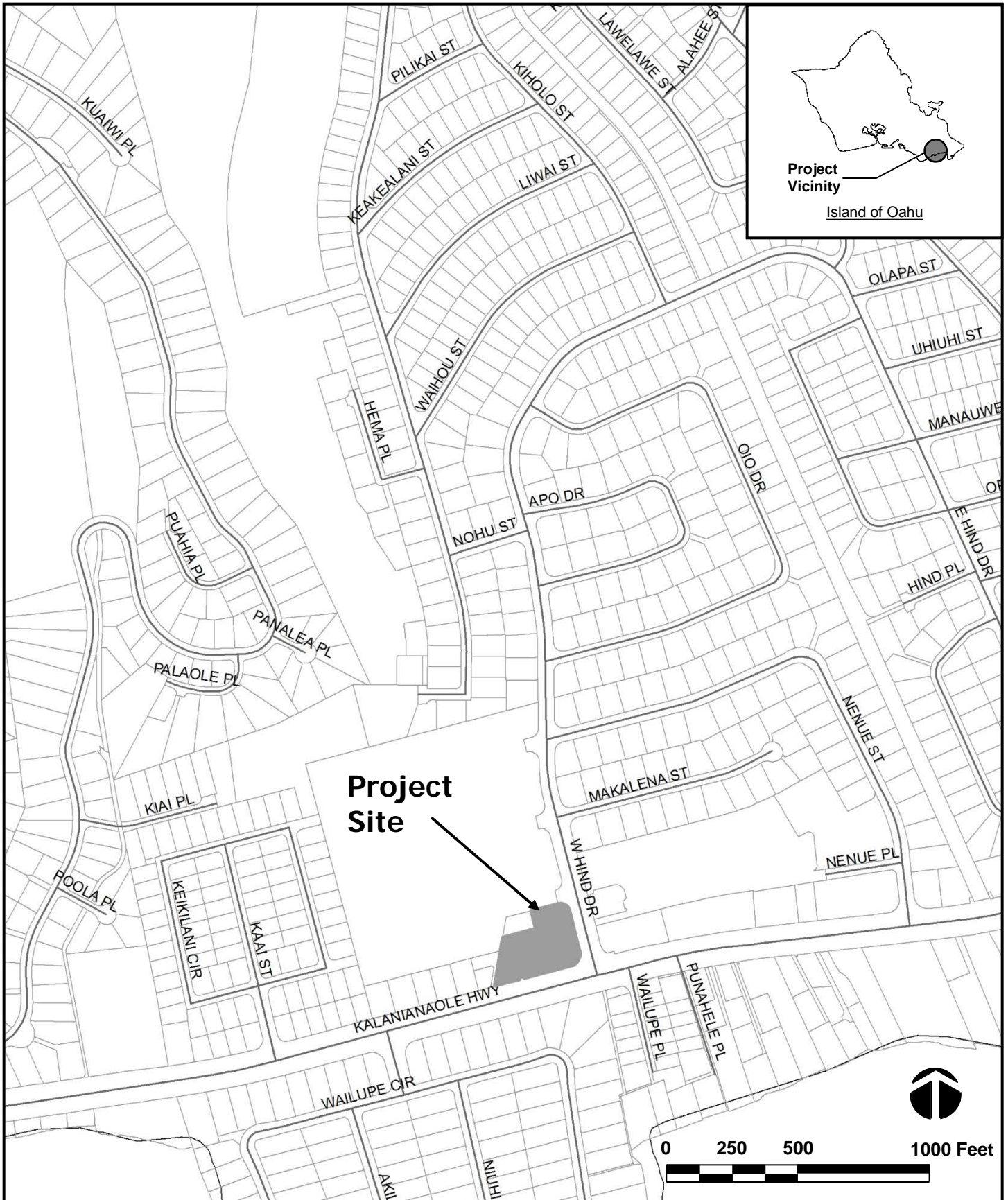

Project Site

LONGS DRUGS AINA HAINA

LOCATION AND VICINITY MAP

FIGURE

1



B. Project Characteristics

The proposed project site currently houses a veterinary clinic building and a two-story Jehovah's Witnesses church. The project includes the replacement of the clinic building with expanded at-grade parking areas and the renovation of the existing church to provide approximately 24,480 square feet of commercial space that is expected to include general merchandise and pharmacy services. The proposed project is expected to be completed by the Year 2015 with access continued to be provided via existing driveways off Kalaniana'ole Highway and West Hind Drive, as well as, a new driveway on the north side of the project site. The driveway off Kalaniana'ole Highway is expected to be a one-way (entering) driveway, the driveway off West Hind Drive is expected to be a two-way driveway with traffic movements restricted to right-turn-in and right-turn-out movements, and the new driveway is expected to be a two-way driveway with exiting traffic movements limited to right-turn-out movements. It should be noted that two-way traffic flow for the driveway off Kalaniana'ole Highway was considered. However, the driveway is not expected to be reconstructed and the existing driveway width is not sufficient to allow for simultaneous turning movements. Figure 2 shows the proposed project site plan.

III. EXISTING TRAFFIC CONDITIONS

A. Area Roadway System

The proposed Longs Drugs Aina Haina store will be located adjacent to Kalaniana'ole Highway in Aina Haina. In the vicinity of the project site, Kalaniana'ole Highway is a predominantly six-lane, two-way divided roadway that serves as a major east-west corridor through east Oahu. During the morning peak period, contraflow operations are implemented along the highway to provide an additional westbound lane for high occupancy vehicles. In conjunction with these operations, turning movements at some of the intersections along this corridor are limited during the AM peak period. West of the project site, Kalaniana'ole Highway intersects Wailupe Circle. At this signalized intersection, the eastbound approach of Kalaniana'ole Highway has three through lanes and an exclusive right-turn lane while the westbound approach has an exclusive left-turn lane (U-turns allowed) and three through lanes. During the morning contraflow operations, the eastbound approach of

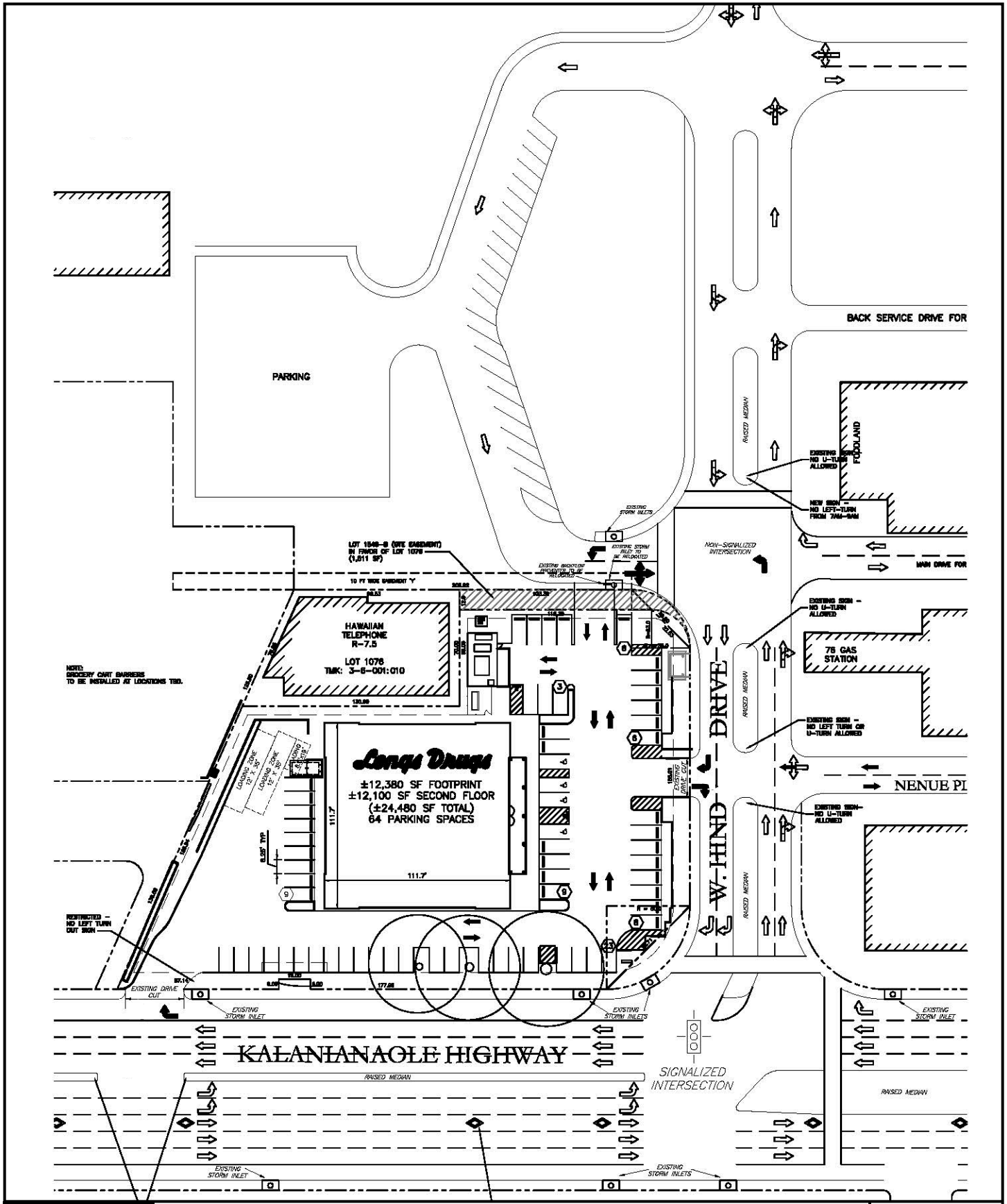

LONGS DRUGS AINA HAINA

PROPOSED SITE PLAN

FIGURE

2



Kalanianaʻole Highway has two through lanes and an exclusive right-turn lane while the westbound approach has an exclusive left-turn and four through lanes. Wailupe Circle is a predominately two-lane, two-way roadway that provides access to the adjacent residential subdivision. At the intersection with Kalanianaʻole Highway, the northbound approach of Wailupe Circle has exclusive left-turn and right-turn lanes.

East of the intersection with Wailupe Circle, Kalanianaʻole Highway intersects West Hind Drive. At this signalized intersection, the eastbound approach of Kalanianaʻole Highway has two exclusive left-turn lanes and three through lanes while the westbound approach has three through lanes and an exclusive right-turn lane. During the morning contraflow operations, the eastbound approach of Kalanianaʻole Highway has two exclusive left-turn lanes and two through lanes while the westbound approach has four through lanes and an exclusive right-turn lane. It should be noted that there is an existing break in the raised median along the highway approximately 300 feet west of the intersection with West Hind Drive that provides access to several parcels along the north side of the highway. During morning contraflow operations, left-turn traffic movements are prohibited at this median break. West Hind Drive is a predominately two-lane, two-way roadway generally oriented in the north-south direction. At the intersection with Kalanianaʻole Highway, the southbound approach of West Hind Drive has two exclusive right-turn lanes.

North of the intersection with Kalanianaʻole Highway, West Hind Drive intersects driveways for the adjacent church and Aina Haina Shopping Center. At this unsignalized intersection, the northbound approach of West Hind Drive has one through lane and a shared through and right-turn lane while the southbound approach has a shared left-turn and through lane, and a shared through and right-turn lane. It should be noted that left-turns and U-turns are prohibited on the northbound approach, and U-turns are prohibited on the southbound approach. The eastbound approach is comprised of a driveway for the adjacent church which has one lane that serves all traffic movements while the westbound approach is comprised of a driveway for the Aina Haina Shopping Center which has one lane that serves all traffic movements.

North of the intersection with the church and shopping center driveways, West Hind Drive intersects a driveway for the Aina Haina Elementary School and another driveway for the Aina Haina Shopping Center. At this unsignalized intersection, the northbound approach of West Hind Drive has one through lane and a shared through and right-turn lane while the southbound approach has one through lane and a shared left-turn and through lane. It should be noted that U-turns are prohibited on both approaches of West Hind Drive. The eastbound approach of the intersection is comprised of an exit driveway for the Aina Highway Elementary School that has one lane that serves all traffic movements while the westbound approach is comprised of another driveway for the Aina Haina Shopping Center that has one lane that serves all traffic movements.

Further north, West Hind Drive intersects a driveway for the Aina Haina Elementary School and Makalena Street. At this unsignalized intersection, the northbound approach of West Hind Drive has two lanes that serve all traffic movements while the southbound approach has one lane that serves all traffic movements. Makalena Street is a two-lane, two-way roadway generally oriented in the east-west direction that dead ends east of West Hind Drive. At the intersection with West Hind Drive, the Makalena Street approach has one lane that serves all traffic movements. The west leg of the intersection is comprised of an entrance driveway for the Aina Haina Elementary School.

At the north end of the study area, West Hind Drive intersects Nenu Street and another driveway for the Aina Haina Elementary School. At this unsignalized intersection, the northbound and southbound approaches of West Hind Drive have one lane that serves all traffic movements. Nenu Street is a predominately two-lane, two-way roadway that extends between West Hind Drive and Kalaniana'ole Highway. At the intersection with West Hind Drive, the westbound approach of Nenu Street has one lane that serves all traffic movements. The eastbound approach of the intersection is comprised of another driveway for the Aina Haina Elementary School and has one lane that serves all traffic movements.

Southeast of the intersection with West Hind Drive, Nenu Street intersects Kalaniana'ole Highway. At this signalized intersection, the southbound approach of

Nenuē Street has a shared left-turn and through lane, and an exclusive right-turn lane. Both approaches of Kalanianaʻole Highway have an exclusive left-turn lane (U-turns allowed), two through lanes, and a shared through and right-turn lane at the intersection with Nenuē Street. During the morning contraflow operations, the eastbound approach of Kalanianaʻole Highway has one through lane and a shared through and right-turn lane while the westbound approach has three through lanes and a shared through and right-turn lane. The northbound approach of the intersection is comprised of a driveway for an adjacent church that has one lane that serves all traffic movements.

B. Traffic Volumes and Conditions

1. General

a. Field Investigation

Field investigations were conducted on September 9, 2014 and consisted of manual turning movement count surveys during the morning peak hours between 6:00 AM and 9:00 AM, and the afternoon peak hours between 3:00 PM and 6:00 PM at the following intersections:

- Kalanianaʻole Highway and Wailupe Circle
- Kalanianaʻole Highway and West Hind Drive
- West Hind Drive and driveways between Kalanianaʻole Highway and Makalena Street
- West Hind Drive and Makalena Street
- West Hind Drive, Nenuē Street, and the School Driveway
- Nenuē Street and Nenuē Place
- Kalanianaʻole Highway, Nenuē Street, and the Church Driveway

Appendix A includes the existing traffic count data.

b. Capacity Analysis Methodology

The highway capacity analysis performed in this study is based upon procedures presented in the “Highway Capacity Manual”, Transportation Research Board, 2000, and the “Synchro” software, developed by Trafficware. The analysis is based on the concept of Level of Service (LOS) to identify the traffic impacts associated with traffic demands during the peak periods of traffic.

LOS is a quantitative and qualitative assessment of traffic operations. Levels of Service are defined by LOS “A” through “F”; LOS “A” representing ideal or free-flow traffic operating conditions and LOS “F” unacceptable or potentially congested traffic operating conditions.

“Volume-to-Capacity” (v/c) ratio is another measure indicating the relative traffic demand to the road carrying capacity. A v/c ratio of one (1.00) indicates that the roadway is operating at or near capacity. A v/c ratio of greater than 1.00 indicates that the traffic demand exceeds the road’s carrying capacity. The LOS definitions are included in Appendix B.

2. Existing Peak Hour Traffic

a. General

Figures 3 and 4 show the existing AM and PM peak period traffic volumes and operating conditions. The AM peak hour of traffic generally occurs between 6:30 AM and 7:30 AM. The PM peak hour of traffic generally occurs between the hours of 5:00 PM and 6:00 PM. The analysis is based on these peak hour time periods for each intersection to identify the traffic impacts resulting from the proposed project. LOS calculations are included in Appendix C.

b. Kalanianaʻole Highway and Wailupe Circle

At the intersection with Wailupe Circle, Kalanianaʻole Highway carries 1,195 vehicles eastbound and 4,706 vehicles westbound during the AM peak period. During the PM peak period, the overall traffic volume was lower with Kalanianaʻole Highway carrying 3,638 vehicles eastbound and 1,843 vehicles westbound. The eastbound approach of Kalanianaʻole Highway operates at LOS “A” and LOS “B” during the AM and PM peak periods, respectively, while the westbound approach operates at LOS “A” during both peak periods. Vehicular queues formed periodically on the highway approaches of the intersection with average queue lengths of 12-17 vehicles observed on both



LEGEND

90
↑
TRAFFIC MOVEMENT VOLUME (VPH)

(A)
APPROACH LEVEL OF SERVICE

↔
LANE USAGE

•
CONES

DATE OF COUNT: September 9, 2014

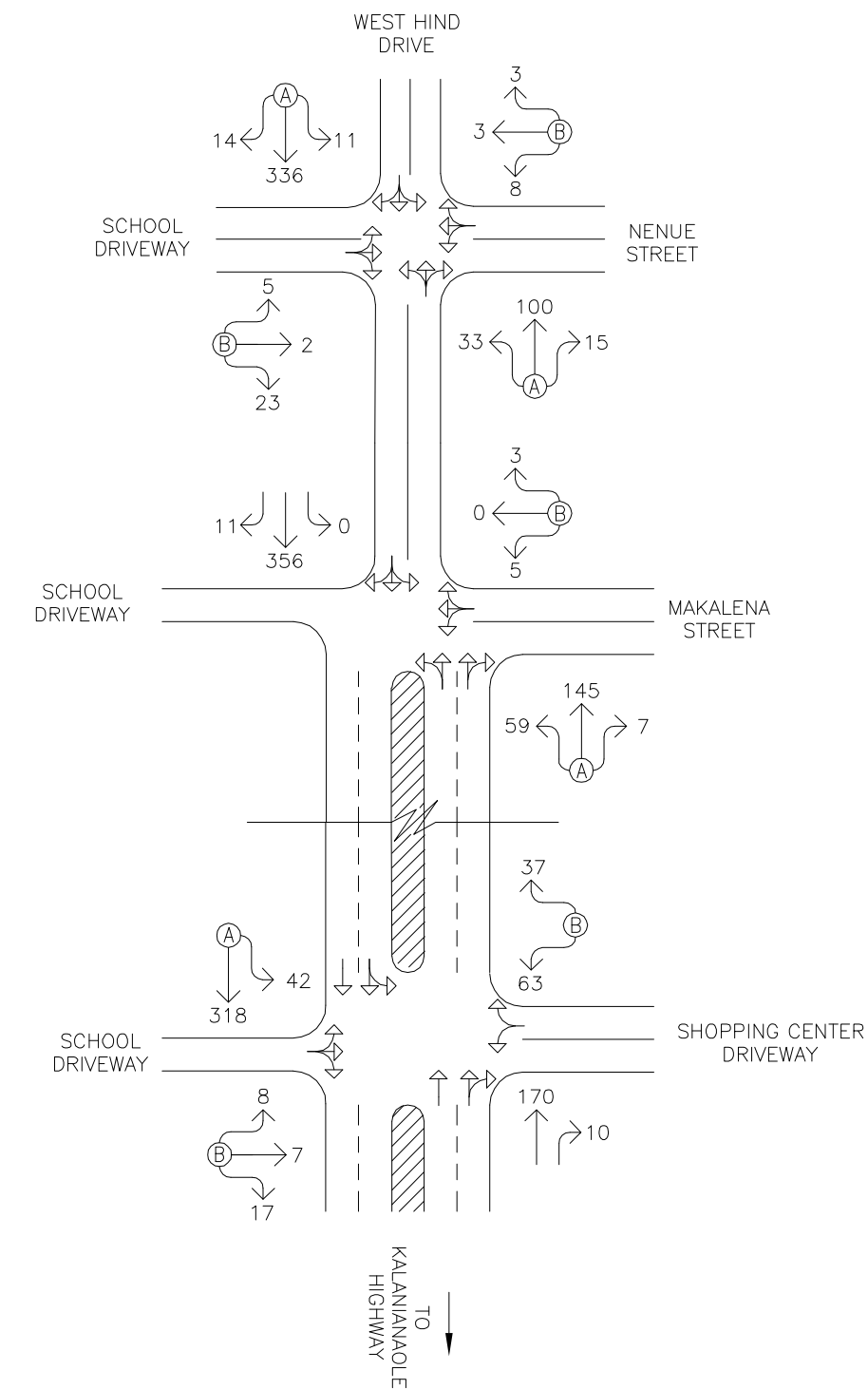
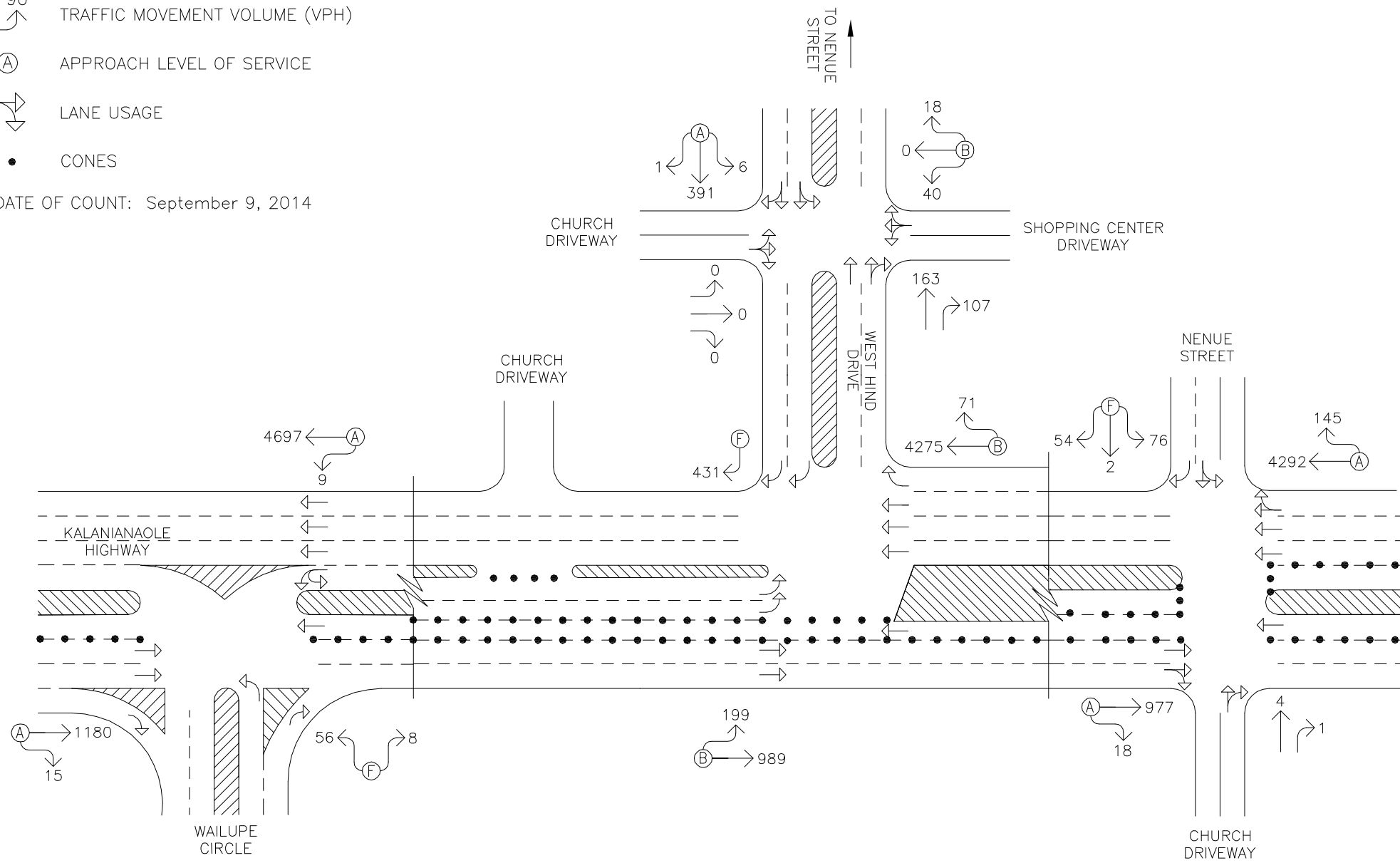

LONGS DRUGS AINA HAINA

EXISTING AM PEAK PERIOD OF TRAFFIC

FIGURE

3



WILSON OKAMOTO CORPORATION



LEGEND

90
↑
TRAFFIC MOVEMENT VOLUME (VPH)

(A)
APPROACH LEVEL OF SERVICE

↔
LANE USAGE

DATE OF COUNT: September 9, 2014

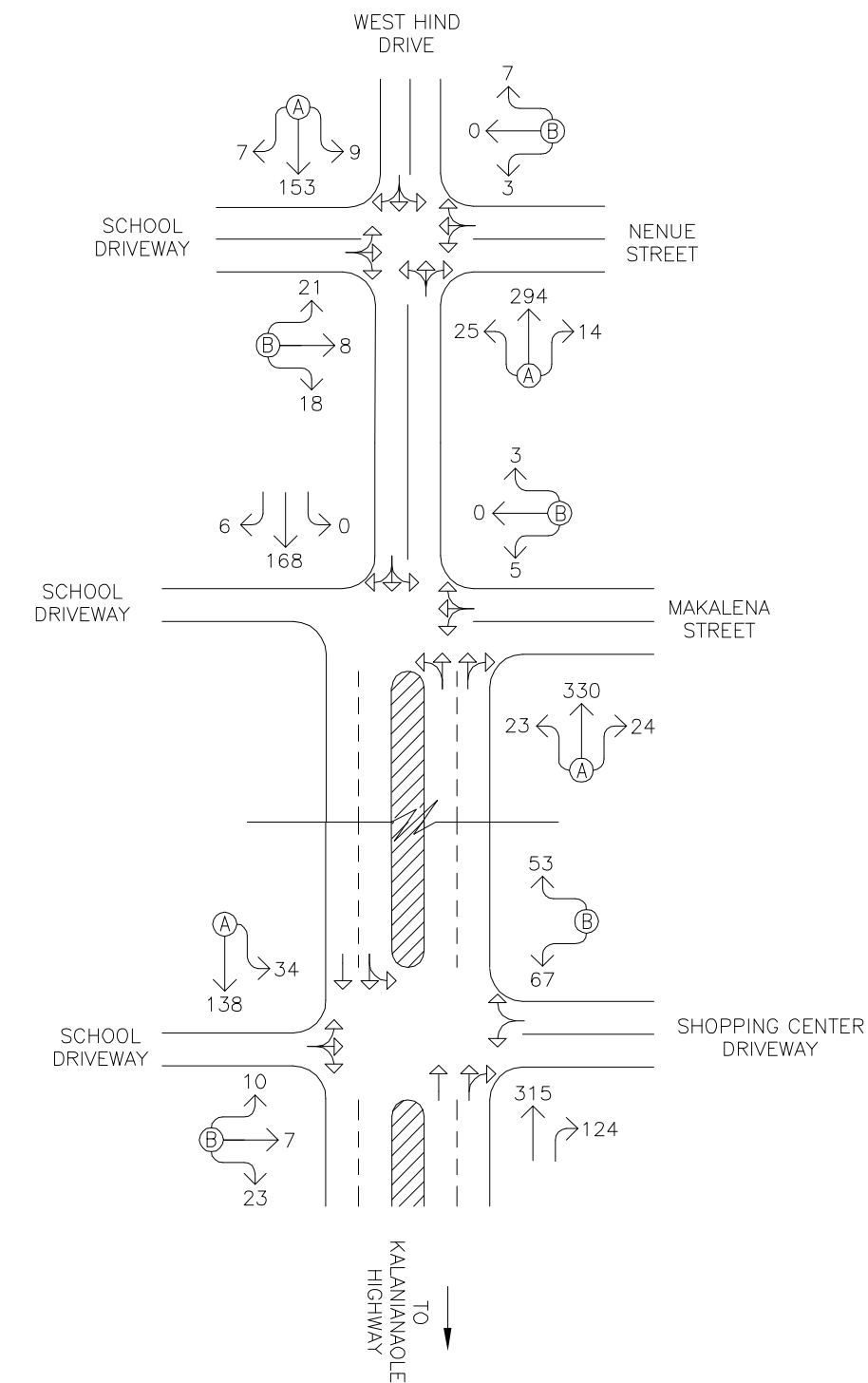
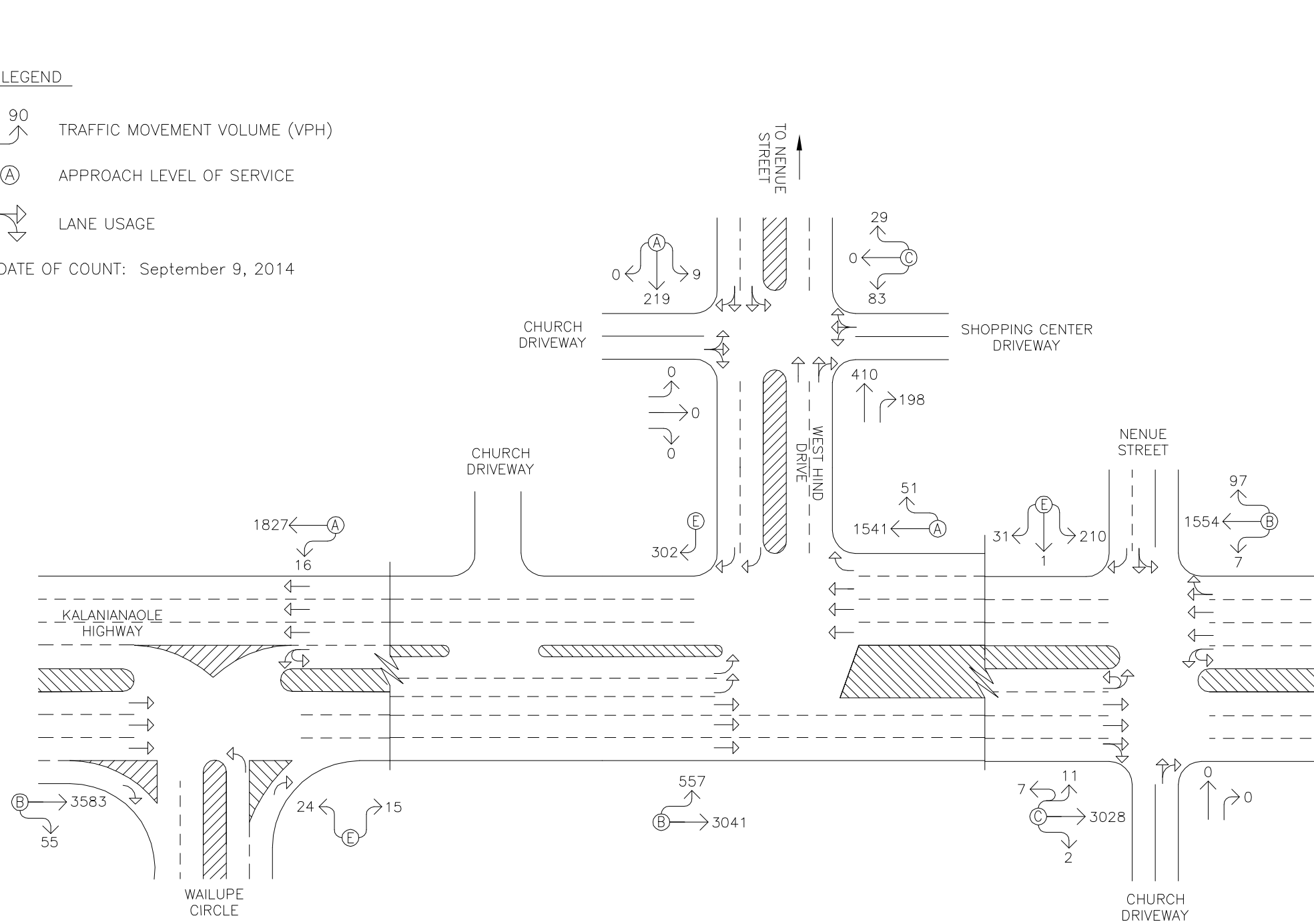

LONGS DRUGS AINA HAINA

EXISTING PM PEAK PERIOD OF TRAFFIC

FIGURE

4



approaches during both peak periods. These queues were observed to clear the intersection after each traffic signal cycle change. The northbound approach of Wailupe Circle carries 64 vehicles during the AM peak period and 39 vehicles during the PM peak period. This approach operates at LOS “F” and LOS “E” during the AM and PM peak periods, respectively. It should be noted that the low levels of service on the Wailupe Circle approach are primarily due to the long traffic signal cycle length at this intersection during the peak periods. Vehicular queues occasionally formed on this approach with average queue lengths of 2-3 vehicles observed during both peak periods. These queues were observed to clear the intersection after each traffic signal cycle change.

c. Kalanianaʻole Highway and West Hind Drive

At the intersection with West Hind Drive, Kalanianaʻole Highway carries 1,188 vehicles eastbound and 4,346 vehicles westbound during the AM peak period. During the PM peak period, the overall traffic volume was lower with Kalanianaʻole Highway carrying 3,598 vehicles eastbound and 1,592 vehicles westbound. The eastbound approach of Kalanianaʻole Highway operates at LOS “B” during both peak periods while the westbound approach operates at LOS “B” and LOS “A” during the AM and PM peak periods, respectively. Vehicular queues formed periodically on the highway approaches of the intersection with average queue lengths of 12-17 vehicles observed on both approaches during both peak periods. These queues were observed to clear the intersection after each traffic signal cycle change. It should be noted that queues in the eastbound left-turn lanes consistently extended beyond the break in the median along the highway.

The southbound approach of West Hind Drive carries 431 vehicles during the AM peak period and 302 vehicles during the PM peak period. This approach operates at LOS “F” and LOS “E” during

the AM and PM peak periods, respectively. It should be noted that the low levels of service on the West Hind Drive approach are primarily due to the long traffic signal cycle length at this intersection during the peak periods. Vehicular queues formed periodically on this approach of the intersection with average queue lengths of 5-8 vehicles observed on this approach during both peak periods. These queues extended through the upstream intersection with the church and shopping center driveways, but were observed to clear the intersection after each traffic signal cycle change.

d. West Hind Drive and Church/Shopping Center Driveways

At the intersection with driveways for the adjacent church and Aina Haina Shopping Center, West Hind Drive carries 270 vehicles northbound and 398 vehicles southbound during the AM peak period. During the PM peak period, the overall traffic volume was higher with West Hind Drive carrying 608 vehicles northbound and 228 vehicles southbound. The southbound approach of West Hind Drive operates at LOS "A" during both peak periods. As previously discussed, queues from the downstream intersection with Kalaniana'ole Highway extended through this intersection during both peak periods. In addition, during the morning peak period, 5-10 minutes prior to the start of classes at the nearby Aina Haina Elementary School, vehicular queues extending from the school's entrance driveway across Makalena Street extended through this intersection and occasionally to Kalaniana'ole Highway. These queues were observed to clear quickly once school was in session.

The Aina Haina Shopping Center driveway approach of the intersection carries 58 vehicles westbound during the AM peak period and 112 vehicles during the PM peak period. This approach operates at LOS "B" and LOS "C" during the AM and PM peak periods, respectively.

The eastbound approach of the intersection is comprised of a driveway for an adjacent church. At the time of the field investigation, the church was closed and, as such, no traffic was observed on this approach during the AM and PM peak hours of traffic.

e. West Hind Drive and School/Shopping Center Driveways

At the intersection with the driveways for the Aina Haina Elementary School and Aina Haina Shopping Center, West Hind Drive carries 180 vehicles northbound and 360 vehicles southbound during the AM peak period. During the PM peak period the overall traffic volume was higher with West Hind Drive carrying 439 vehicles northbound and 172 vehicles southbound. The southbound approach of West Hind Drive operates at LOS "A" during both peak periods. As previously discussed, queues extending from the school's entrance driveway extended through this intersection during the AM peak period, but were observed to clear quickly once school at the nearby Aina Haina Elementary School was in session.

The Aina Haina Shopping Center driveway approach of the intersection carries 100 vehicles westbound during the AM peak period and 120 vehicles westbound during the PM peak period. This approach operates at LOS "B" during both peak periods.

The Aina Haina Elementary School driveway approach of the intersection carries 32 vehicles eastbound during the AM peak period and 40 vehicles eastbound during the PM peak period. This approach operates at LOS "B" during both peak periods.

f. West Hind Drive and Makalena Street

At the intersection with Makalena Street, West Hind Drive carries 211 vehicles northbound and 367 vehicles southbound during the AM peak period. During the PM peak period the overall traffic volume was lower with West Hind Drive carrying 377 vehicles northbound and 174 vehicles southbound. The northbound approach of West Hind Drive operates at LOS "A" during both peak periods.

As previously discussed, queues extending from this intersection extended through downstream intersections during the AM peak period, but were observed to clear quickly once school was in session.

The Makalena Street approach of the intersection carries a relatively low volume of traffic throughout the day with 8 vehicles observed on this approach during both peak periods. This approach operates at LOS “B” during both peak periods.

g. West Hind Drive and Nenu Street

At the intersection with Nenu Street and a driveway for Aina Haina Elementary School, West Hind Drive carries 148 vehicles northbound and 361 vehicles southbound during the AM peak period. During the PM peak period, the overall traffic volume was lower with West Hind Drive carrying 333 vehicles northbound and 169 vehicles southbound. The northbound and southbound approaches of West Hind Drive operates at LOS “A” during both peak periods.

The Nenu Street approach of the intersection carries 14 vehicles westbound during the AM peak period and 10 vehicles westbound during the PM peak period. This approach operates at LOS “B” during both peak periods.

The eastbound approach of the intersection is comprised of a driveway for Aina Haina Elementary School which carries 30 vehicles during the AM peak period and 47 vehicles during the PM peak period. The school driveway approach operates at LOS “B” during both peak periods.

h. Kalanianaʻole Highway and Nenu Street

At the intersection with Nenu Street, Kalanianaʻole Highway carries 995 vehicles eastbound and 4,437 vehicles westbound during the AM peak period. During the PM peak period, the overall traffic volume was lower with Kalanianaʻole Highway carrying 3,048 vehicles eastbound and 1,658 vehicles westbound. The eastbound approach of Kalanianaʻole Highway operates at LOS “A” and LOS “C” during the

AM and PM peak periods, respectively, while the westbound approach operates at LOS “A” and LOS “B” during the AM and PM peak periods, respectively. Vehicular queues formed periodically on the highway approaches of the intersection with average queue lengths of 12-17 vehicles observed on both approaches during both peak periods. These queues were observed to clear the intersection after each traffic signal cycle change.

The Nenu Street approach of the intersection carries 132 vehicles southbound during the AM peak period and 242 vehicles southbound during the PM peak period. This approach operates at LOS “F” and LOS “E” during the AM and PM peak periods, respectively. It should be noted that the low levels of service on the Nenu Street approach are primarily due to the long traffic signal cycle length at this intersection during the peak periods. Vehicular queue formed periodically on this approach of the intersection with average queue lengths of 4-8 vehicles observed during both peak periods.

The northbound approach of the intersection is comprised of a driveway for an adjacent church which carries a minimal volume of traffic during the AM and PM peak periods. 5 vehicles were observed on the approach during the AM peak period and no vehicles were observed on the approach during the PM peak period.

IV. PROJECTED TRAFFIC CONDITIONS

A. General

Access to the proposed Longs Drugs Aina Haina store is expected to be provided via two existing driveways off Kalanianaʻole Highway and West Hind Drive, as well as, a new driveway on the north side of the project site. However, the new driveway on the north side of the project site requires coordination with the Department of Education and Hawaiian Telecom that may not be resolved within the timeframe of the proposed project. As such, two additional alternatives are currently under consideration. The provision of the driveway on the north side of the project site is hereinafter referred to as “Alternative 1.” The second alternative (referred to as

“Alternative 2”) assesses conditions if the driveway on the north side of the property cannot be constructed within the timeframe of the project. Access to the project site under this alternative is limited to the existing driveways along Kalanianaʻole Highway and West Hind Drive. The third alternative (referred to as “Alternative 3”) assesses conditions where access to the project site is limited to the two existing driveways off Kalanianaʻole Highway and West Hind Drive, and a traffic circle is constructed at the intersection of West Hind Drive, Makalena Street, and a driveway for the adjacent Aina Haina Elementary School. The City and County of Honolulu, Department of Transportation Services (DTS) recently held traffic calming workshops within the surrounding community. At these workshops, the community expressed concerns regarding the speed of vehicles along West Hind Drive and suggested the construction of a roundabout or traffic circle at the intersection of West Hind Drive and Makalena Street as a potential solution.

B. Site-Generated Traffic

1. Trip Generation Methodology

The trip generation methodology used in this study is based upon generally accepted techniques developed by the Institute of Transportation Engineers (ITE) and published in “Trip Generation, 9th Edition,” 2012. The ITE trip generation rates are developed empirically by correlating the vehicle trip generation data with various land use characteristics such as the number of vehicle trips generated per 1,000 square feet of development. Table 1 summarizes the trip generation characteristics related to the proposed Longs Drugs Aina Haina store applied to the AM and PM peak hours of traffic.

Table 1: Peak Hour Trip Generation

PHARMACY/DRUGSTORE WITHOUT DRIVE-THROUGH WINDOW		
INDEPENDENT VARIABLE:		1,000 sf of development = 24.48
		PROJECTED TRIP ENDS
AM PEAK	ENTER	47
	EXIT	25
	TOTAL	72
PM PEAK	ENTER	101
	EXIT	105
	TOTAL	206

2. Trip Distribution

a. General

Figures 5 to 10 show the distribution of site-generated traffic during the AM and PM peak periods under the three alternatives. Under all three alternatives, access to the Longs Drugs Aina Haina store will be provided via an existing entrance driveway off Kalanianaʻole Highway and a two-way driveway off West Hind Drive. In addition, Alternative 1 includes an additional access on the north side of the project site. The directional distribution of site-generated vehicles was based on the existing distribution of traffic along Kalanianaʻole Highway. As such, 19.7% of trips were assumed to be traveling eastbound and 80.3% of trips were assumed to be traveling westbound during the AM peak period. During the PM peak period, 66.2% of trips were assumed to be traveling eastbound and 33.8% were assumed to be traveling westbound.

b. Alternative 1

Under Alternative 1, access to the Longs Drugs Aina Haina store will be provided via an existing entrance driveway off Kalanianaʻole Highway and a two-way driveway off West Hind Drive, as well as, a new driveway on the north side of the project site. In conjunction with the provision of the new driveway on the north side of the project site, the existing exit driveway for the adjacent Aina Haina Elementary School will be modified to allow for two-way traffic between West Hind Drive and the project driveway. At West Hind Drive, the modified school driveway will continue to allow all turning movements. As such, turning movements at the existing project driveway along West Hind Drive are assumed to be restricted to right-turn-in and right-turn-out movements to minimize conflicts between left-turning vehicles from the project site and through traffic along West Hind Drive. During the peak periods, westbound entering vehicles were assumed to use the driveway off Kalanianaʻole Highway



LEGEND

- 90 TRAFFIC MOVEMENT VOLUME (VPH)
- LANE USAGE
- CONES

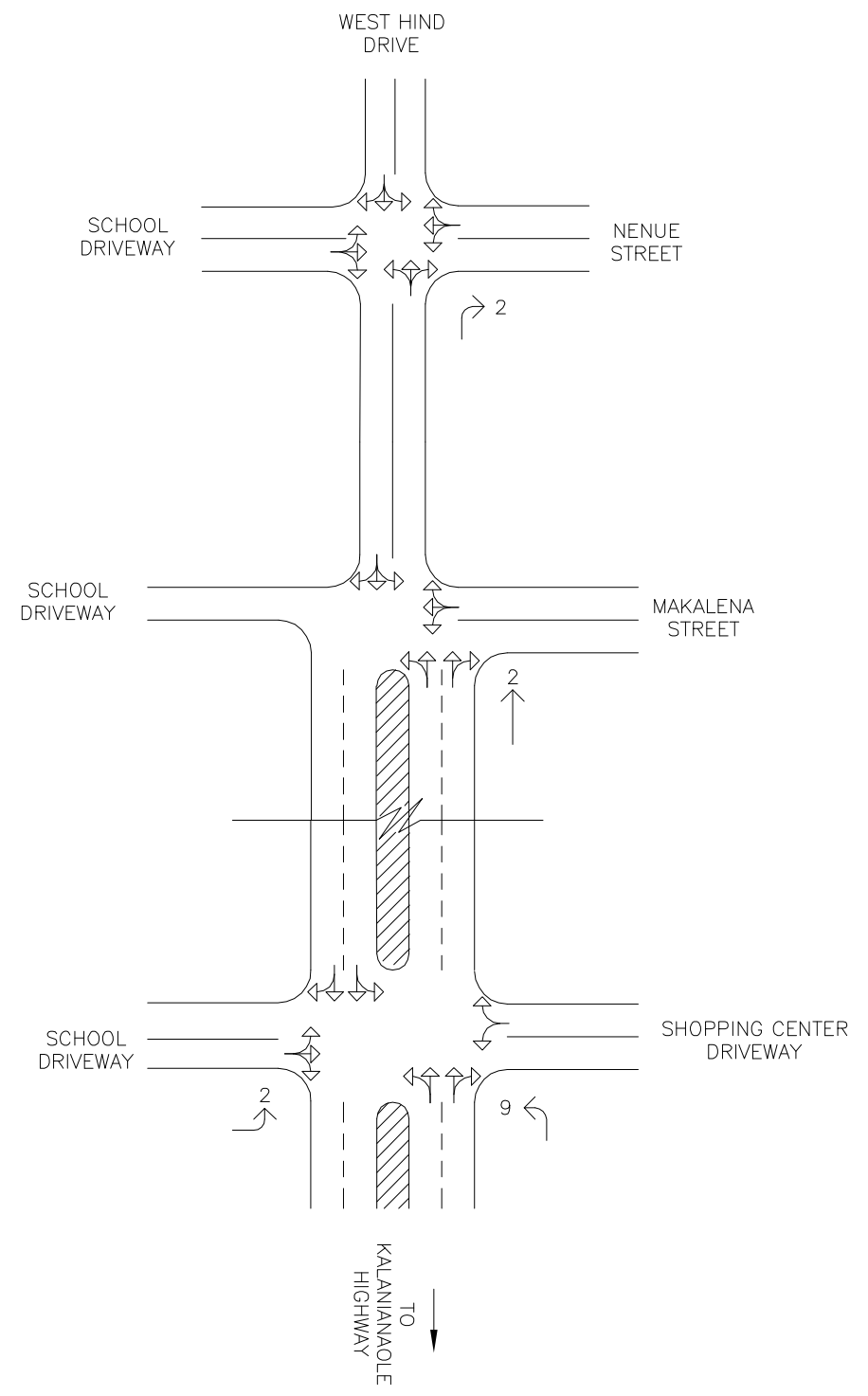
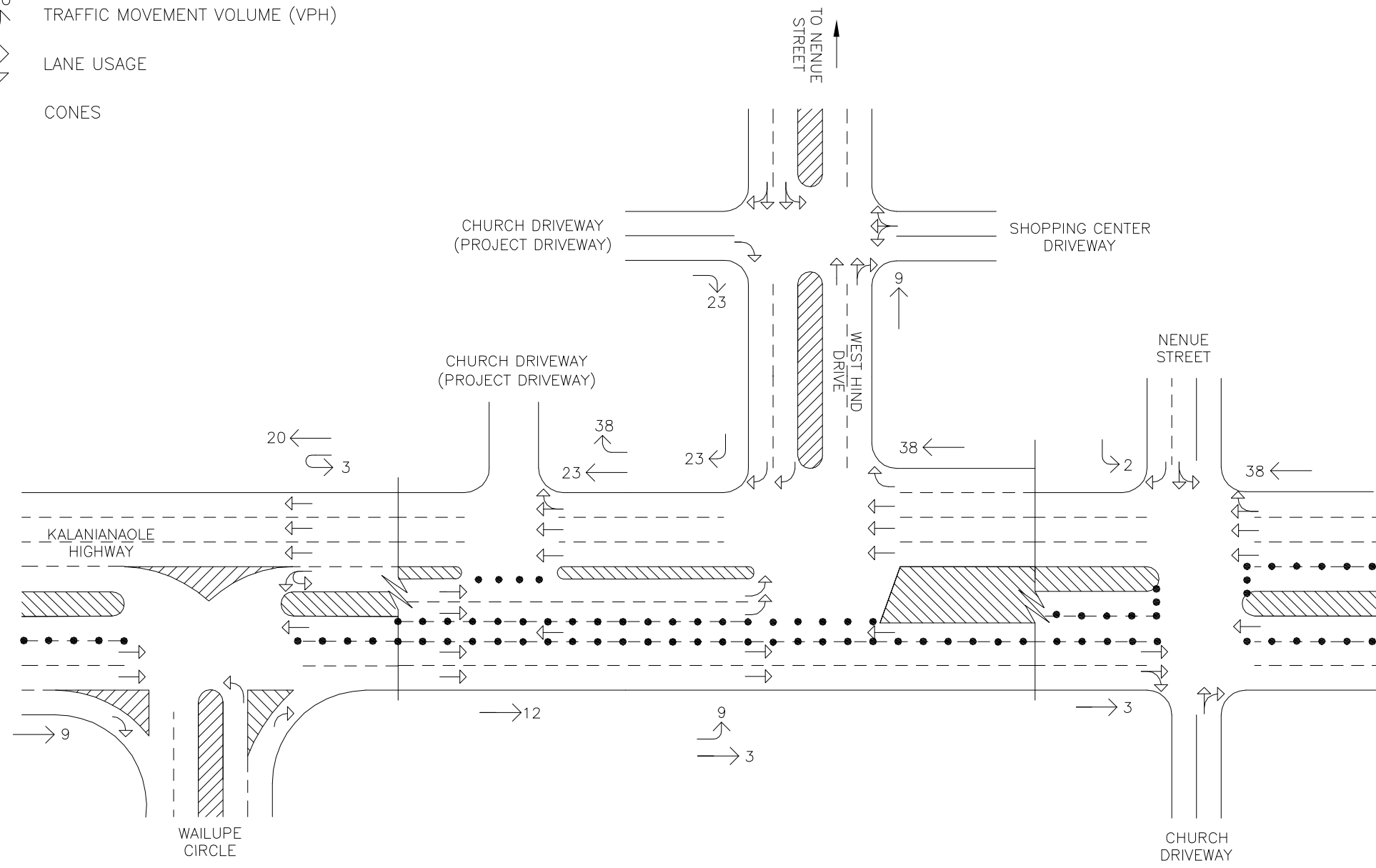

LONGS DRUGS AINA HAINA

YEAR 2015 DISTRIBUTION OF SITE-GENERATED VEHICLES
AM PEAK PERIOD OF TRAFFIC WITH ALTERNATIVE 1

FIGURE
5





LEGEND

- 90
↑
TRAFFIC MOVEMENT VOLUME (VPH)
- ↔
LANE USAGE

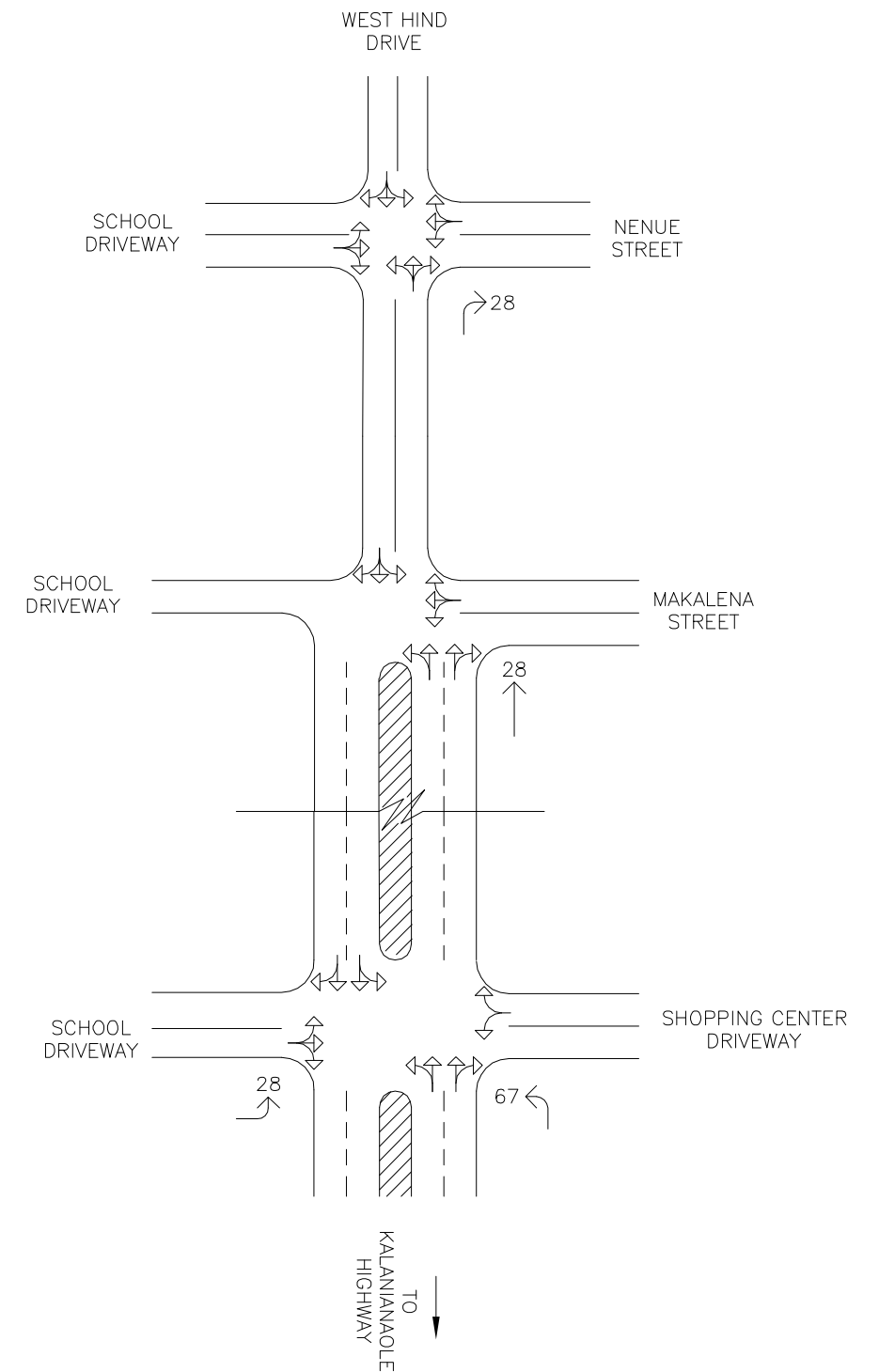
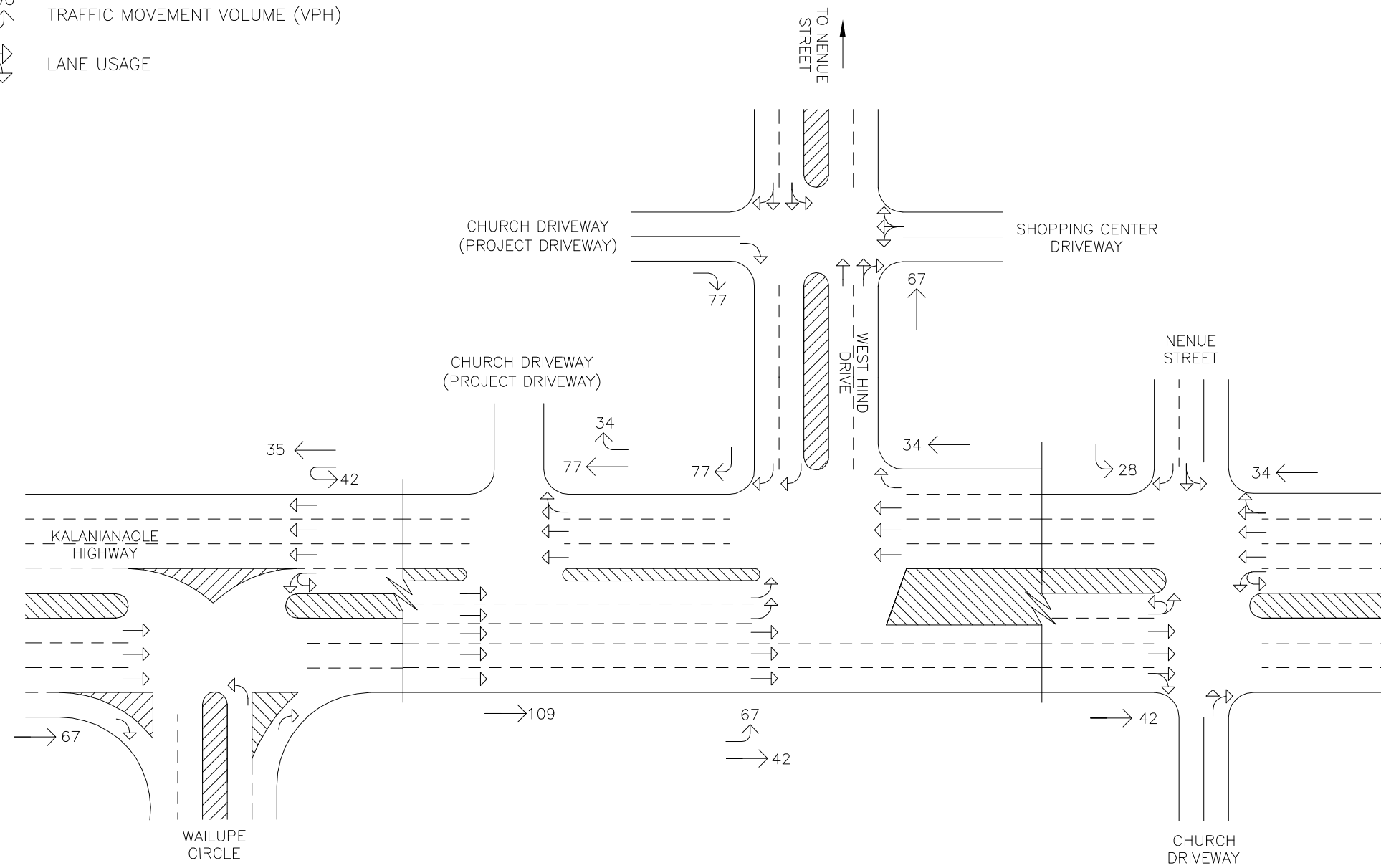

LONGS DRUGS AINA HAINA

YEAR 2015 DISTRIBUTION OF SITE-GENERATED VEHICLES
PM PEAK PERIOD OF TRAFFIC WITH ALTERNATIVE 1

FIGURE

6





LEGEND

- 90 TRAFFIC MOVEMENT VOLUME (VPH)
- LANE USAGE
- CONES

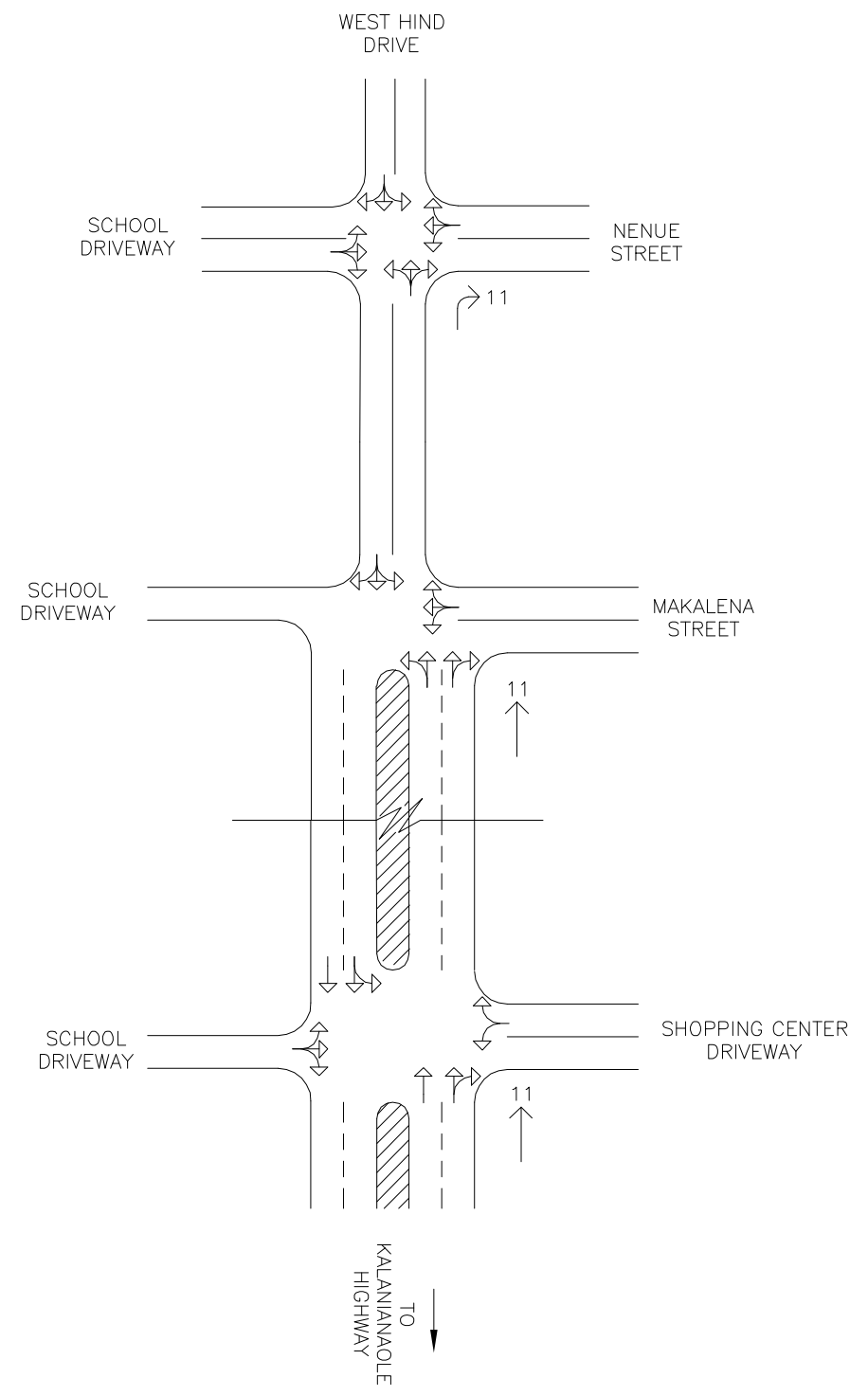
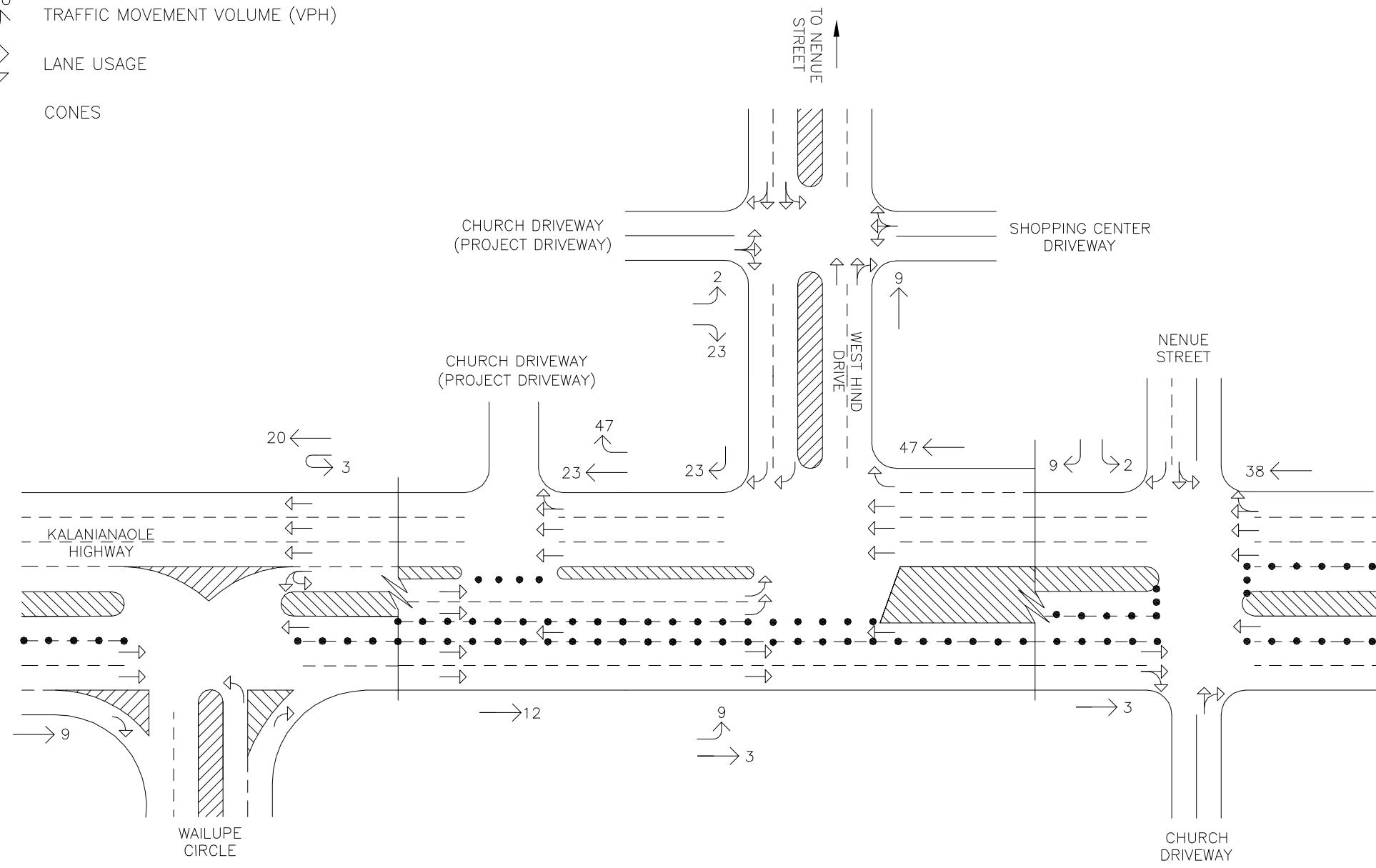

LONGS DRUGS AINA HAINA

YEAR 2015 DISTRIBUTION OF SITE-GENERATED VEHICLES
AM PEAK PERIOD OF TRAFFIC WITH ALTERNATIVE 2

FIGURE
7





LEGEND

- 90
↑ TRAFFIC MOVEMENT VOLUME (VPH)
- ↔ LANE USAGE

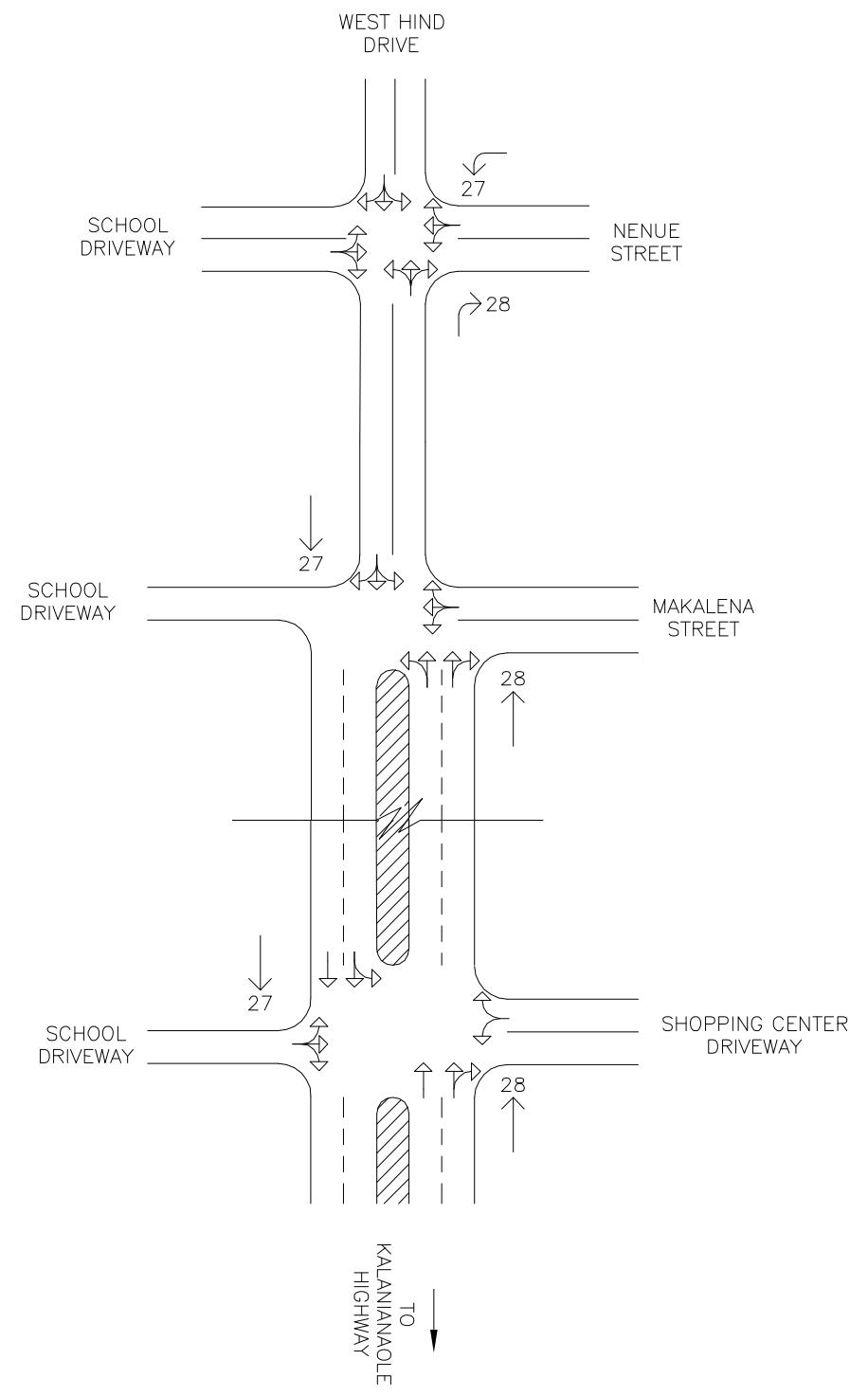
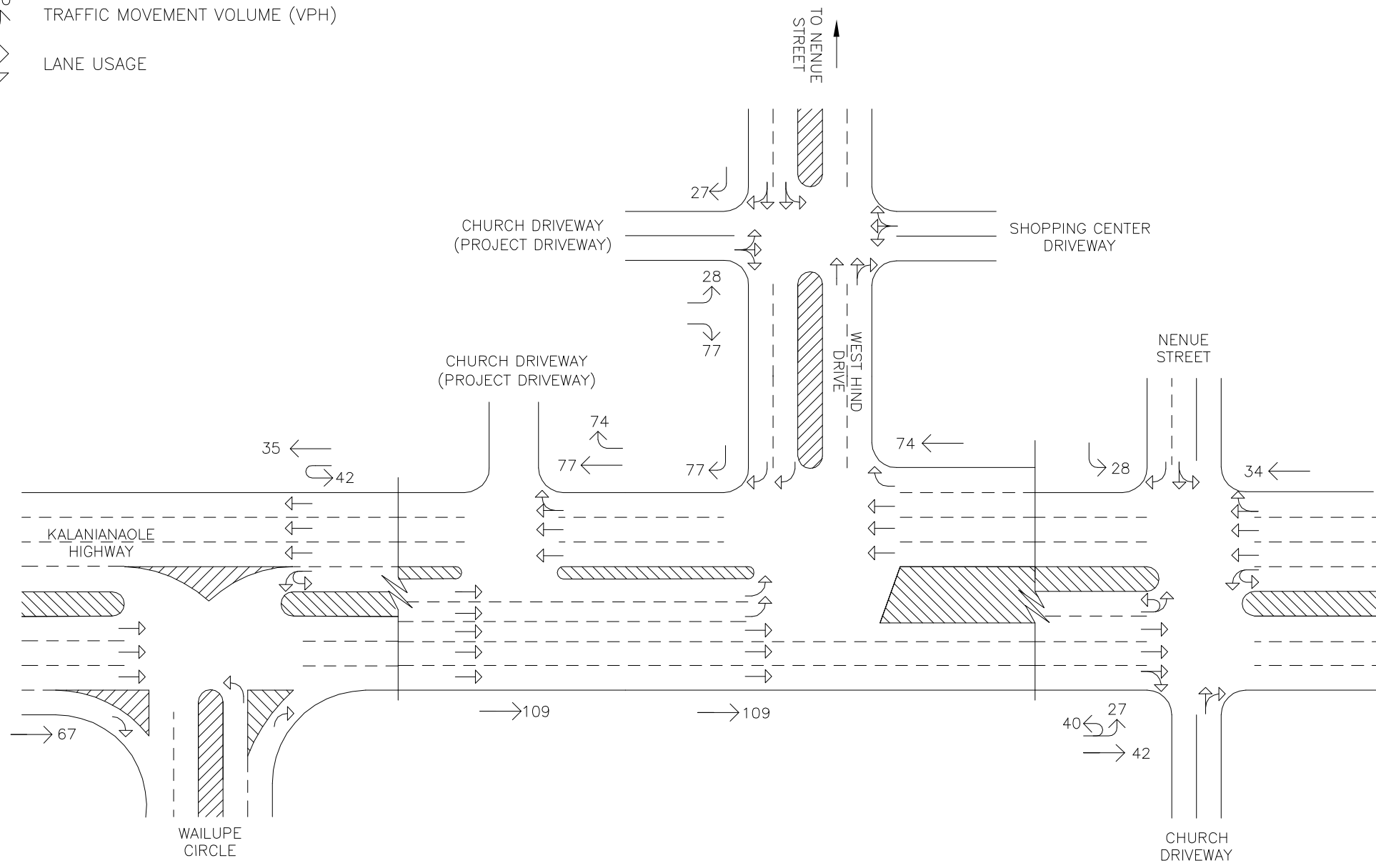

LONGS DRUGS AINA HAINA

YEAR 2015 DISTRIBUTION OF SITE-GENERATED VEHICLES
PM PEAK PERIOD OF TRAFFIC WITH ALTERNATIVE 2

FIGURE

8





LEGEND

- 90 TRAFFIC MOVEMENT VOLUME (VPH)
- LANE USAGE
- CONES

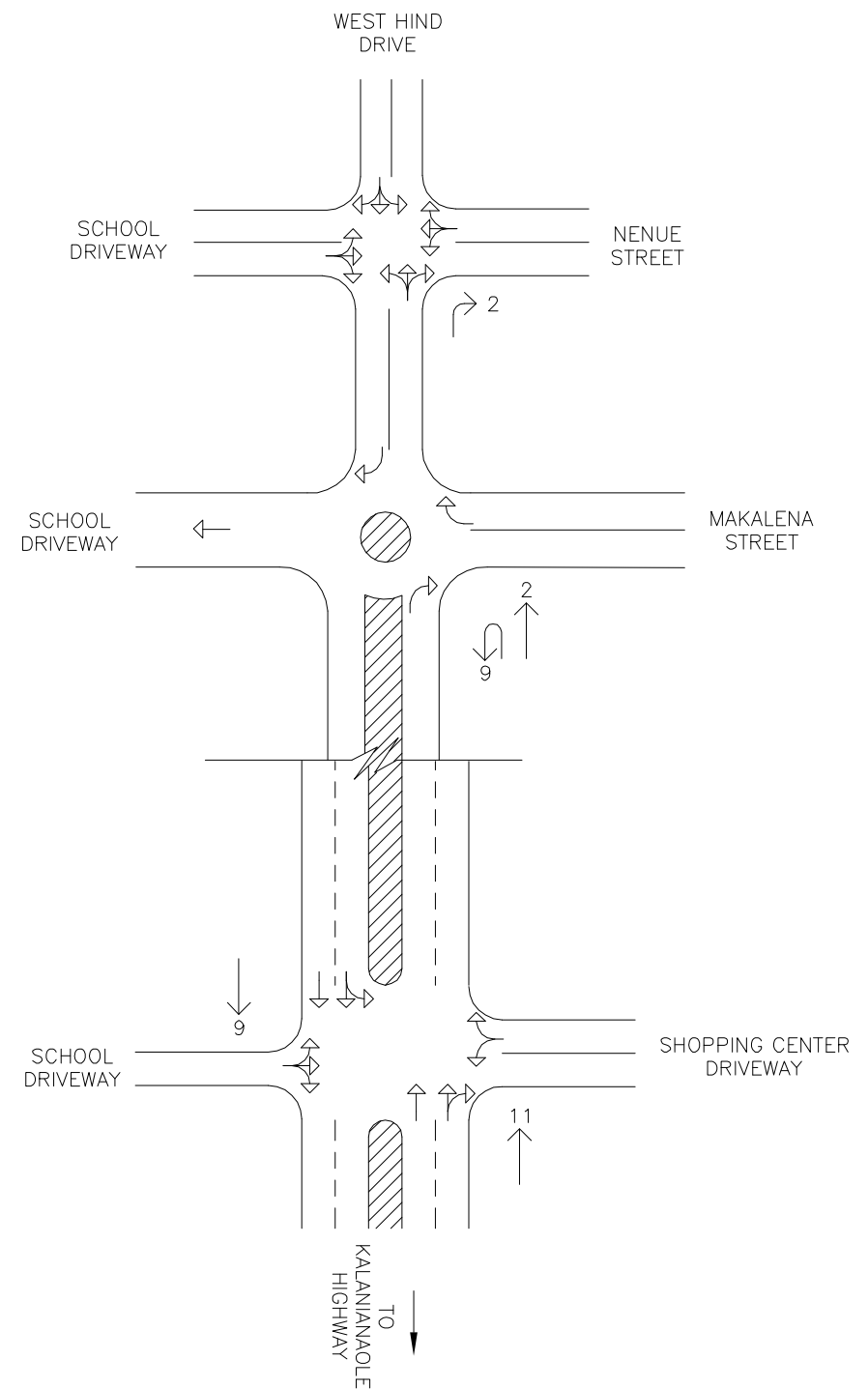
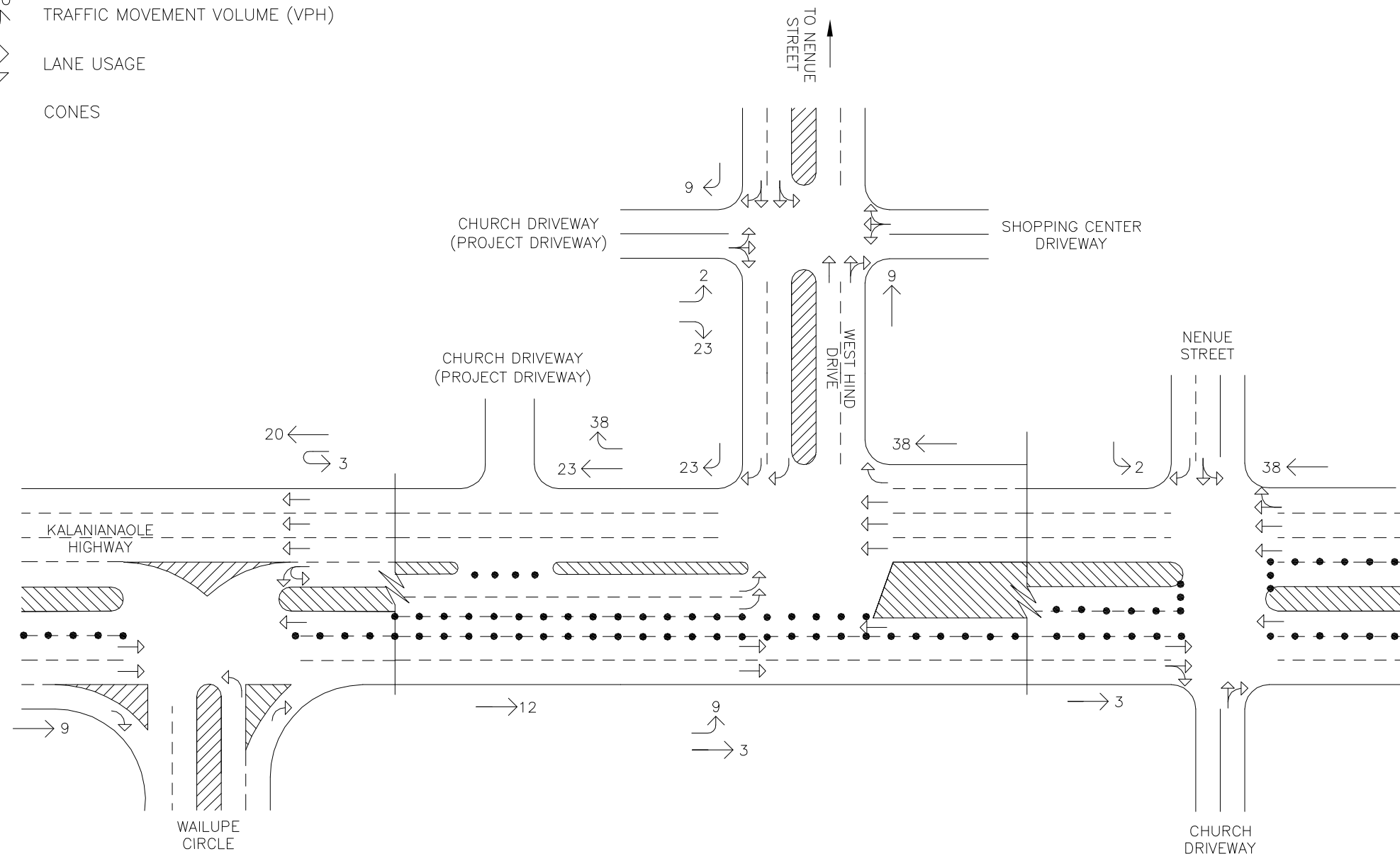

LONGS DRUGS AINA HAINA

YEAR 2015 DISTRIBUTION OF SITE-GENERATED VEHICLES
AM PEAK PERIOD OF TRAFFIC WITH ALTERNATIVE 3

FIGURE
9





LEGEND

- 90
↑
TRAFFIC MOVEMENT VOLUME (VPH)
- ↔
LANE USAGE

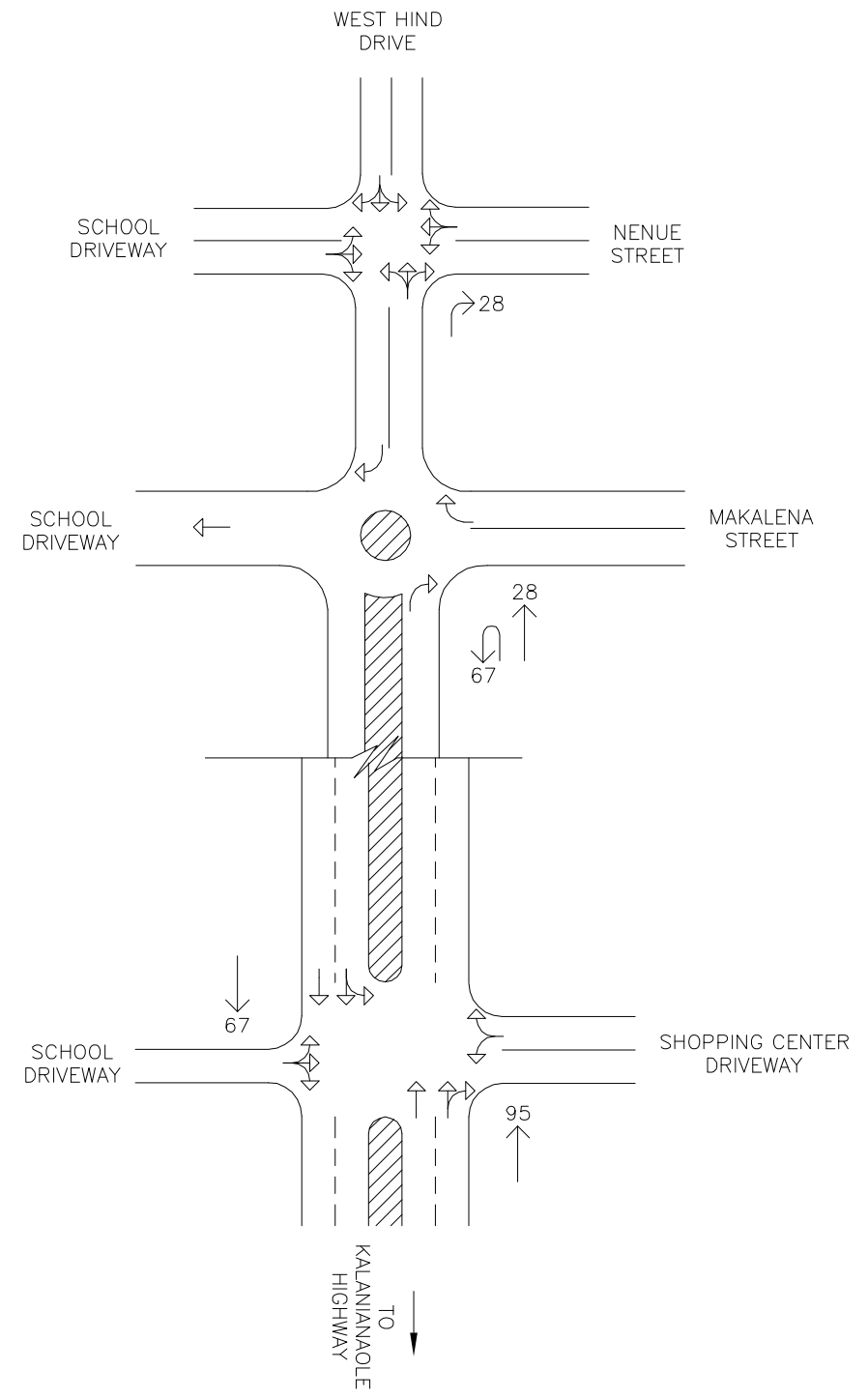
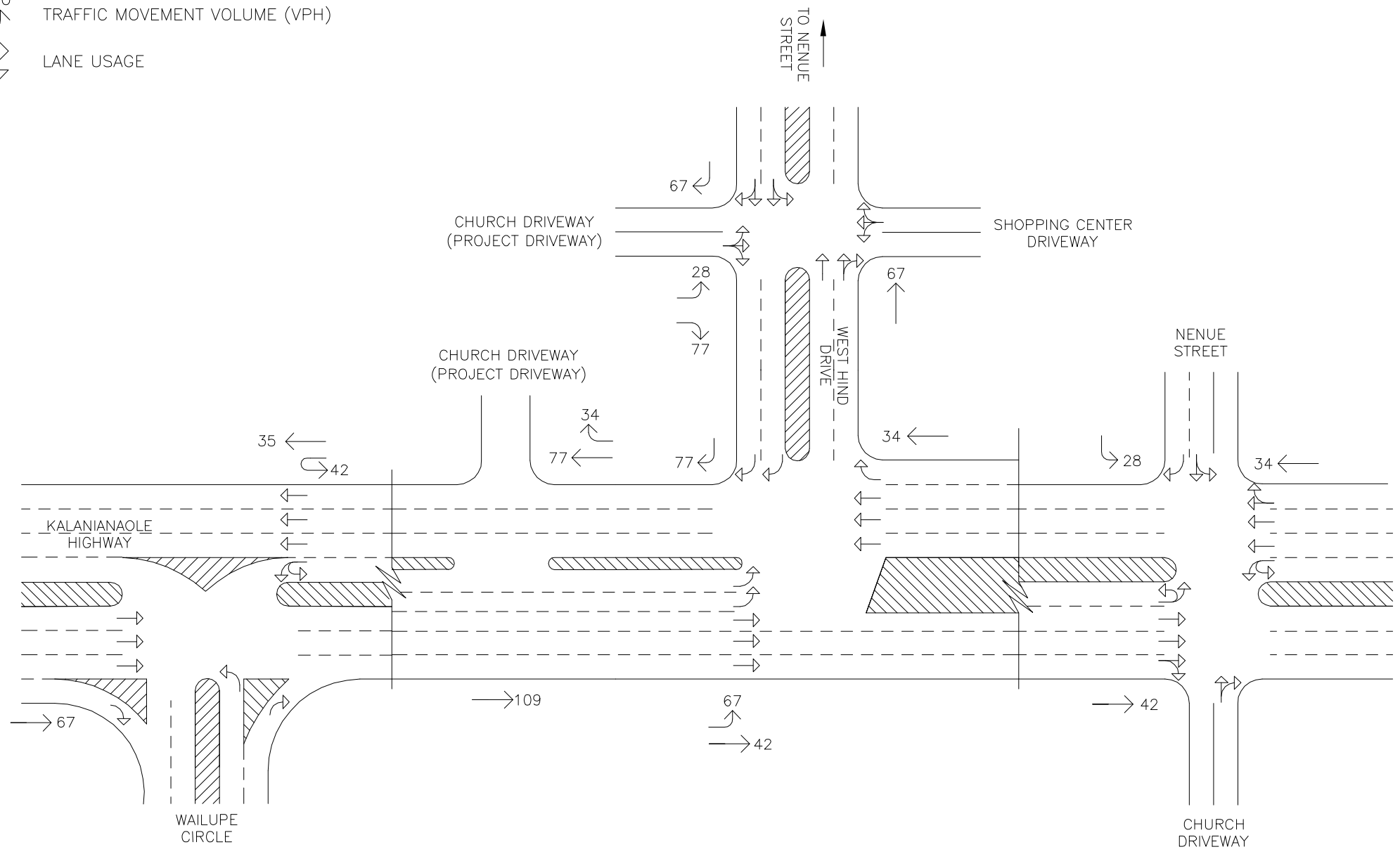

LONGS DRUGS AINA HAINA

YEAR 2015 DISTRIBUTION OF SITE-GENERATED VEHICLES
PM PEAK PERIOD OF TRAFFIC WITH ALTERNATIVE 3

FIGURE

10



to access the site while eastbound entering vehicles were assumed to turn left onto West Hind Drive to access the new project driveway on the north side of the project site. Exiting vehicles were assigned to the project driveways based on their assumed destination and relative convenience of the available routes. Exiting westbound vehicles were assumed to use the existing driveway off West Hind Drive to head directly to Kalanianaʻole Highway. Exiting eastbound vehicles were assumed use the driveway off West Hind Drive to access Kalanianaʻole Highway and make a U-turn at the intersection with Wailupe Circle or use the new driveway on the north side of the project site, turn left on West Hind Drive, and use Nenuē Street to access Kalanianaʻole Highway.

c. Alternative 2

Under Alternative 2, access to the Longs Drugs Aina Haina store will be provided via an existing entrance driveway off Kalanianaʻole Highway and a two-way driveway off West Hind Drive. Due to the proximity of the driveway along Kalanianaʻole Highway to the intersection with West Hind Drive and the existing and projected volume of traffic along the highway, vehicles accessing the project site were conservatively assumed to modify their route and turn right into the driveway even if the resulting route was not the most convenient. During the AM peak period, westbound entering vehicles were assumed to use the driveway off Kalanianaʻole Highway to access the site while eastbound entering vehicles were assumed to turn left onto West Hind Drive then use Nenuē Street to access Kalanianaʻole Highway (westbound) and the project driveway off the highway. During the PM peak period, westbound entering vehicles were assumed to use the driveway off Kalanianaʻole Highway while eastbound entering vehicles were assumed to either make a U-turn at Nenuē Street to access the driveway off the highway or turn onto Nenuē Street and use that roadway to access the driveway off West

Hind Drive. All exiting vehicles were assigned to the driveway off West Hind Drive with westbound vehicles assumed to head directly to Kalanianaʻole Highway. Eastbound vehicles were assumed to either turn left on West Hind Drive and use Nenuē Street to access Kalanianaʻole Highway or turn right on West Hind Drive, turn right onto Kalanianaʻole Highway, and make a U-turn at the intersection with Wailupe Circle.

d. Alternative 3

Under Alternative 3, access to the Longs Drugs Aina Haina store will be provided via an existing entrance driveway off Kalanianaʻole Highway and a two-way driveway off West Hind Drive. During the peak periods, westbound entering vehicles were assumed to use the driveway off Kalanianaʻole Highway to access the site while eastbound entering vehicles were assumed to turn left onto West Hind Drive then use the new traffic circle at Makalena Street to make a U-turn and access the project driveway off West Hind Drive. All exiting vehicles were assigned to the driveway off West Hind Drive with westbound vehicles assumed to head directly to Kalanianaʻole Highway. Eastbound vehicles were assumed to either turn left on West Hind Drive and use Nenuē Street to access Kalanianaʻole Highway or turn right on West Hind Drive, turn right onto Kalanianaʻole Highway, and make a U-turn at the intersection with Wailupe Circle.

C. Through Traffic Forecasting Methodology

The travel forecast is based upon historical traffic count data obtained from the State DOT, Highways Division at survey stations located along Kalanianaʻole Highway in the vicinity of the project site. The historical data indicates relatively stable traffic volumes along Kalanianaʻole Highway. As such, an annual traffic growth rate of approximately 2.0 % was conservatively assumed along Kalanianaʻole Highway in the project vicinity. Using 2014 as the Base Year, a growth rate factor of

1.02 was applied to the existing through traffic demands along Kalaniana'ole Highway to achieve the projected Year 2015 traffic demands.

D. Total Traffic Volumes Without Project

The projected Year 2015 AM and PM peak period traffic volumes and operating conditions without the development of the Longs Drugs Aina Haina store are shown in Figures 11 and 12, and summarized in Table 2. The existing levels of service are provided for comparison purposes. LOS calculations are included in Appendix D.

Table 2: Existing and Projected Year 2015 (Without Project) LOS Traffic Operating Conditions

Intersection	Approach/Critical Movement	AM		PM	
		Exist	Year 2015 w/out Proj	Exist	Year 2015 w/out Proj
Kalaniana'ole Hwy/ Wailupe Cir	Eastbound	A	A	B	B
	Westbound	A	A	A	A
	Northbound	F	F	E	E
Kalaniana'ole Hwy/ West Hind Dr	Eastbound	B	B	B	B
	Westbound	B	B	A	A
	Southbound	F	F	E	E
West Hind Dr/ Church Dwy/ Shopping Center Dwy	Westbound	B	B	C	C
	Southbound	A	A	A	A
West Hind Dr/ School Dwy/ Shopping Center Dwy	Eastbound	B	B	B	B
	Westbound	B	B	B	B
	Southbound	A	A	A	A
West Hind Dr/ Makalena St	Westbound	B	B	B	B
	Northbound	A	A	A	A
West Hind Dr/ Nenua St	Eastbound	B	B	B	B
	Westbound	B	B	B	B
	Northbound	A	A	A	A
	Southbound	A	A	A	A
Kalaniana'ole Hwy/ Nenua St	Eastbound	A	A	C	C
	Westbound	A	A	B	B
	Southbound	F	F	E	E



LEGEND

- 90 TRAFFIC MOVEMENT VOLUME (VPH)
- (A) APPROACH LEVEL OF SERVICE
- LANE USAGE
- CONES

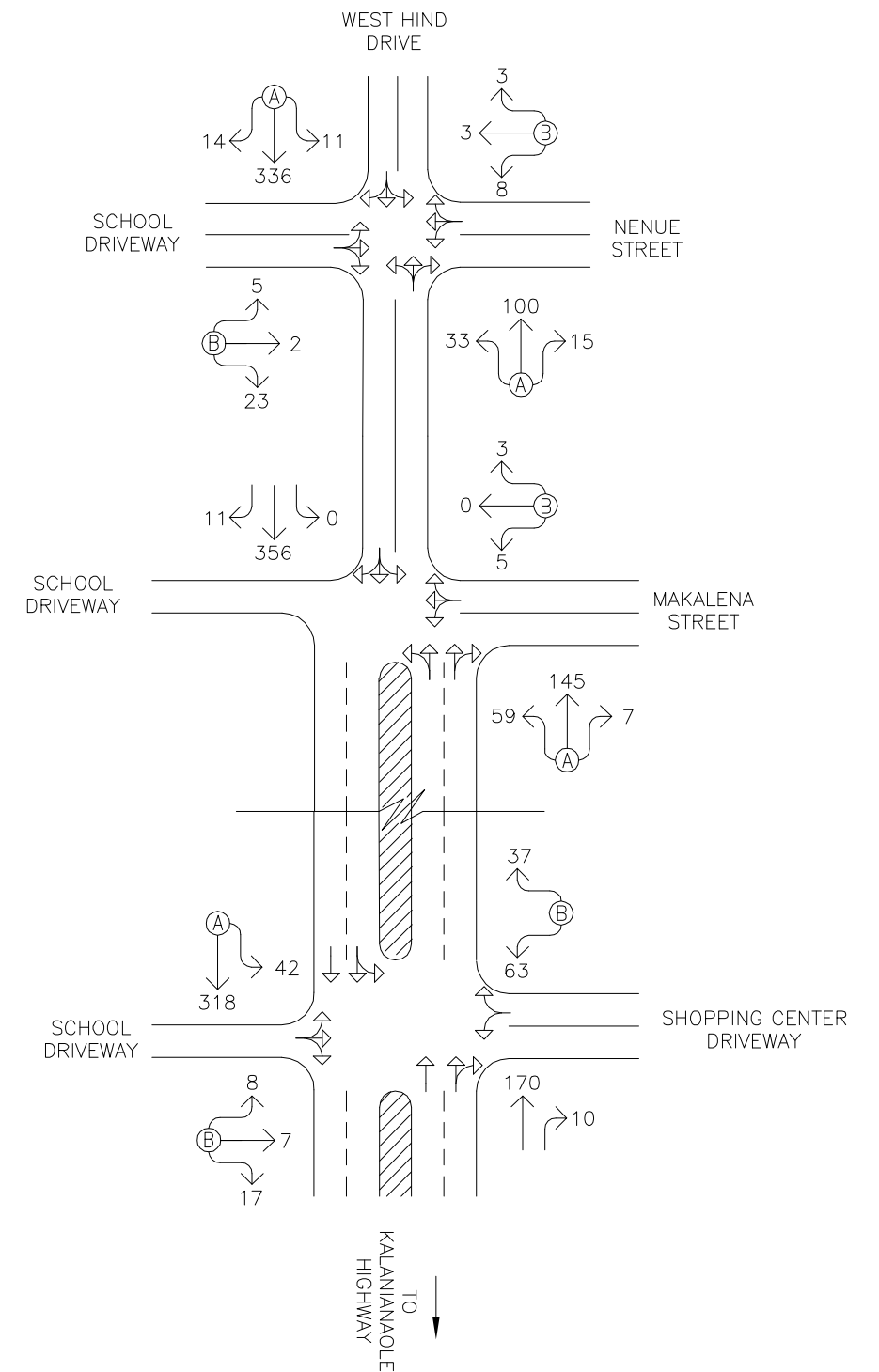
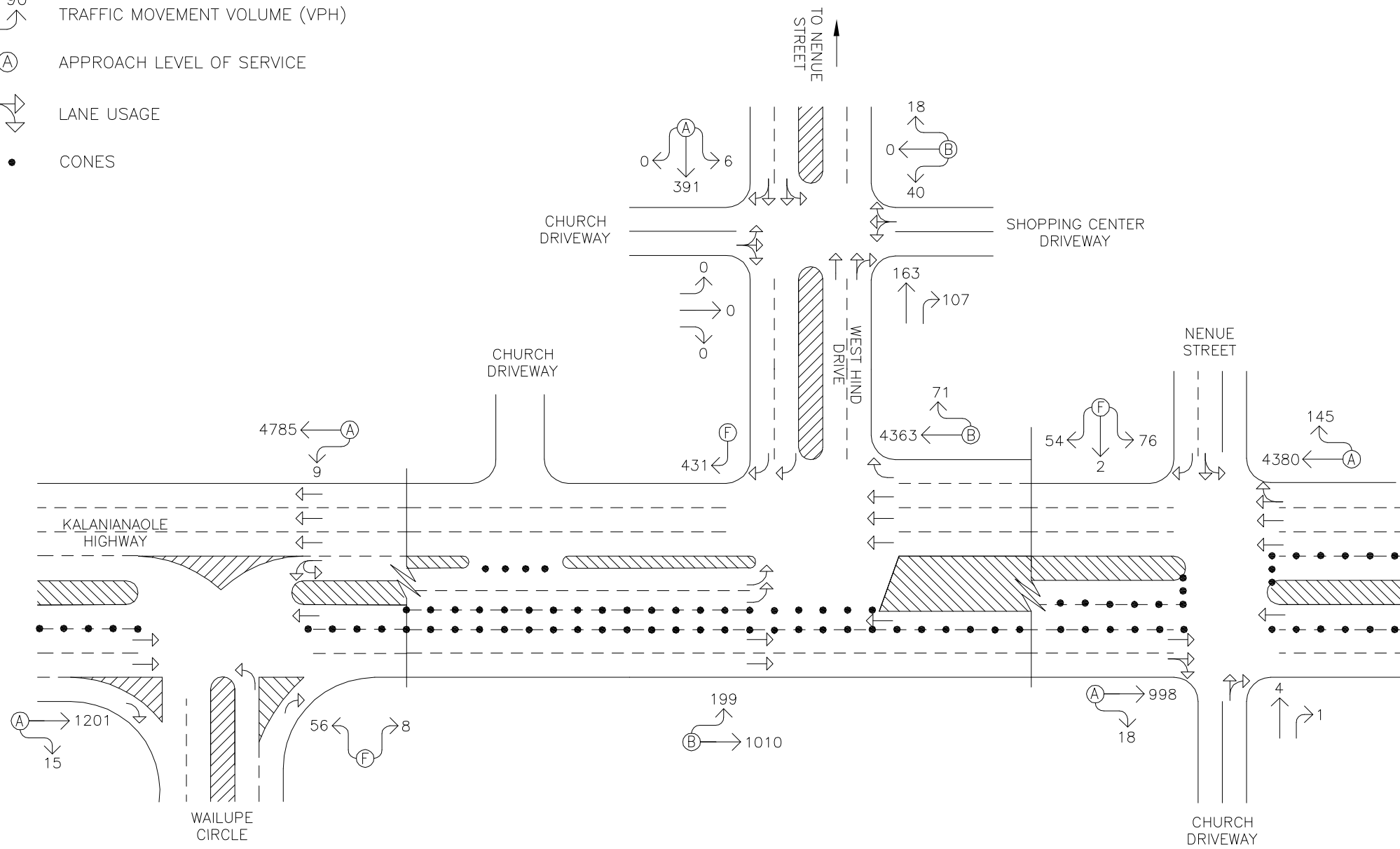

LONGS DRUGS AINA HAINA

YEAR 2015 AM PEAK PERIOD OF TRAFFIC WITHOUT PROJECT

FIGURE

11





LEGEND

- 90 TRAFFIC MOVEMENT VOLUME (VPH)
- (A) APPROACH LEVEL OF SERVICE
- LANE USAGE

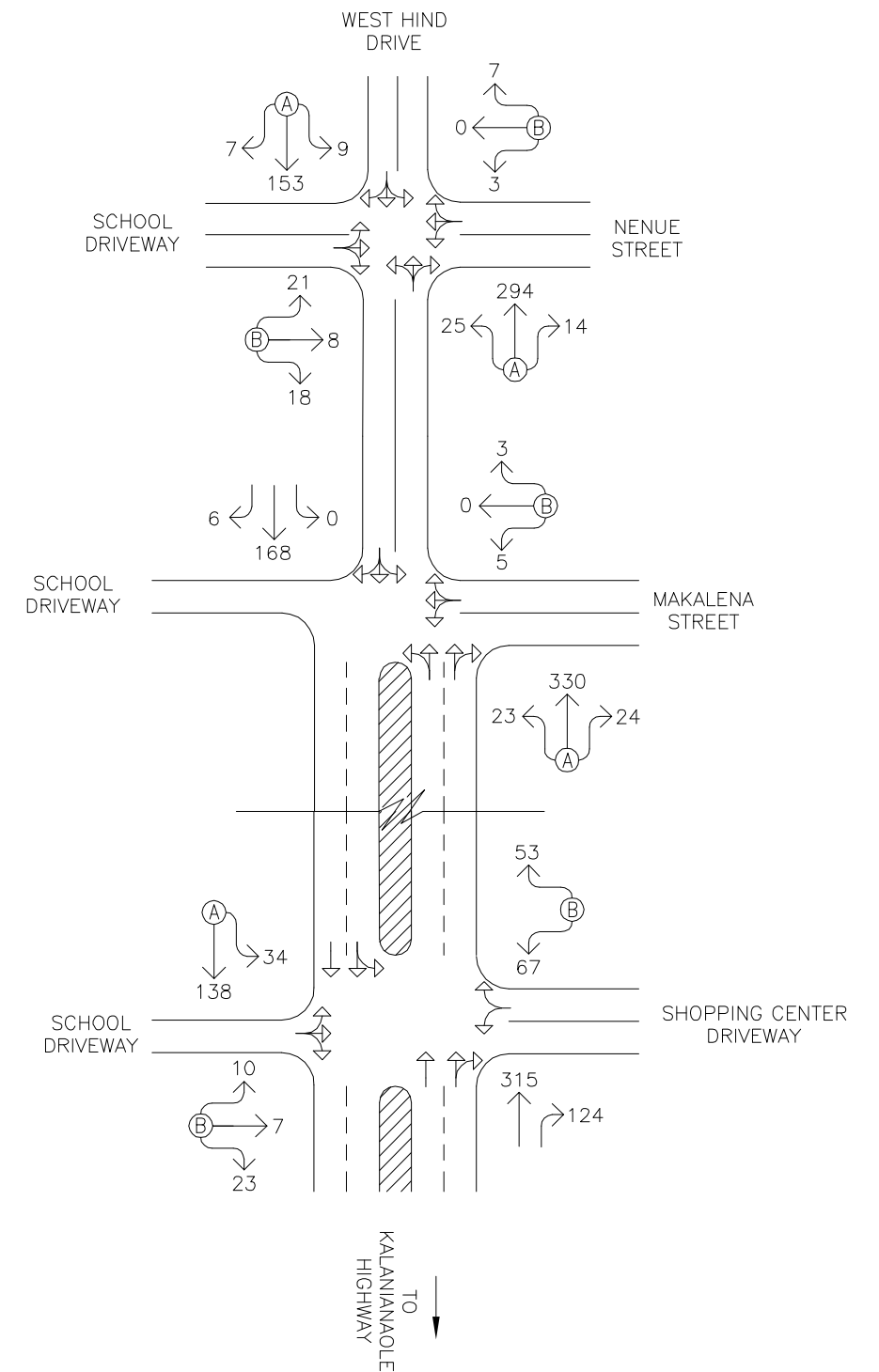
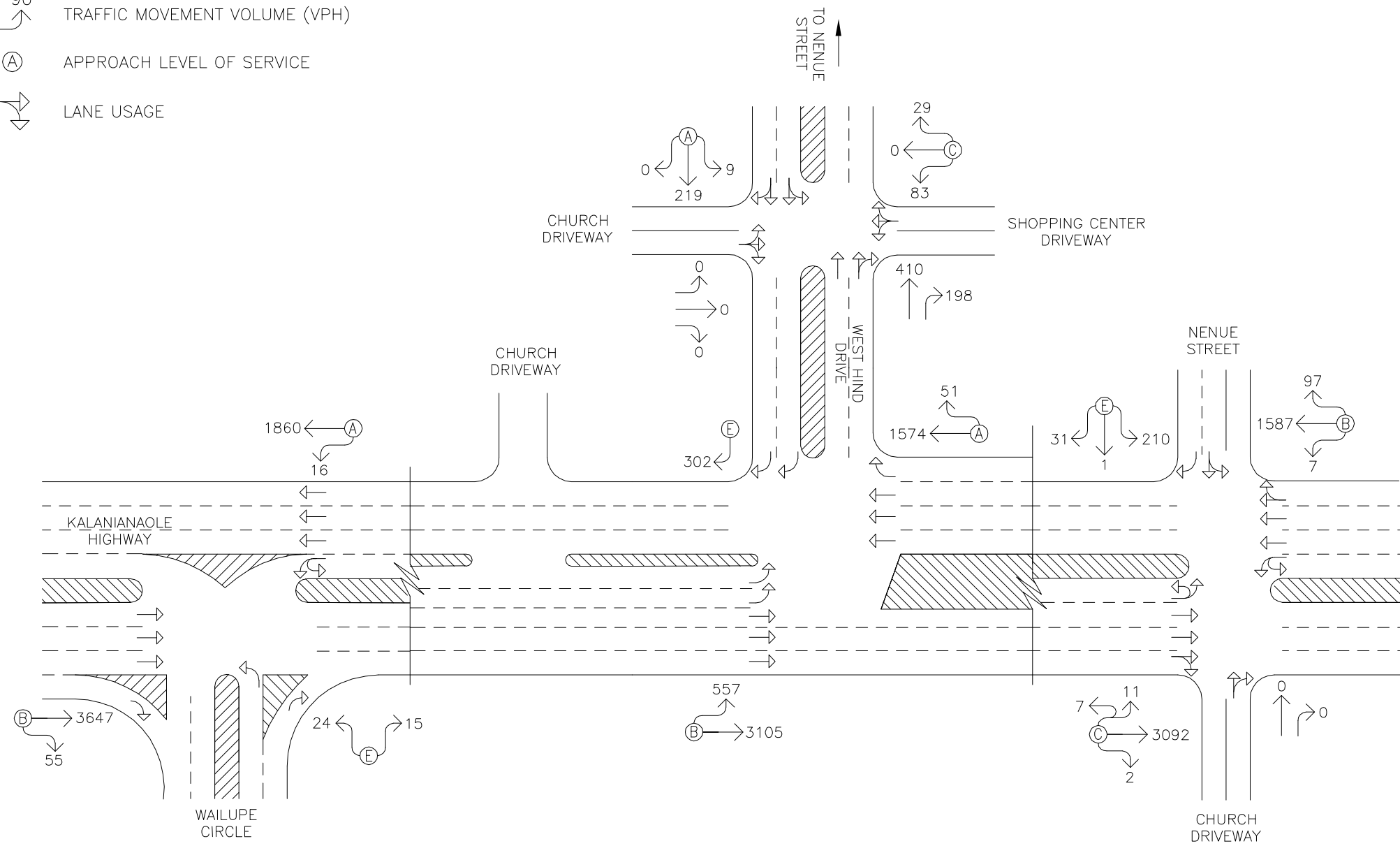

LONGS DRUGS AINA HAINA

YEAR 2015 PM PEAK PERIOD OF TRAFFIC WITHOUT PROJECT

FIGURE

12



WILSON OKAMOTO CORPORATION

Under Year 2015 without project conditions, traffic operations are expected to remain similar to existing conditions. Traffic operations at the study intersections along Kalanianaʻole Highway are expected to continue operating at LOS “B” or better during the AM peak period and LOS “C” or better during the PM peak period with the exception of the side street approaches of the intersections along the highway. The Wailupe Circle, West Hind Drive, and Nenu Street approaches of these intersections are expected to continue operating at LOS “F” during the AM peak period and LOS “E” during the PM peak period. As previously discussed, the low levels of service along the side streets are primarily due to the long traffic signal cycle lengths along the highway. Along West Hind Drive, traffic operations at the other study intersections are expected to continue operating at LOS “C” or better during both peak periods.

E. Total Traffic Volumes With Project

Figures 13 to 18 show the Year 2015 cumulative AM and PM peak hour traffic conditions resulting from the projected external traffic and the proposed Longs Drugs Aina Haina store. The cumulative volumes consist of site-generated traffic superimposed over Year 2015 projected traffic demands. The traffic impacts resulting from the proposed project are addressed in the following section.

V. TRAFFIC IMPACT ANALYSIS

A. Alternative 1

The Year 2015 cumulative AM and PM peak hour traffic conditions with the implementation of Alternative 1 for the Longs Drugs Aina Haina store are summarized in Table 3. The existing and projected Year 2015 (Without Project) operating conditions are provided for comparison purposes. LOS calculations are included in Appendix E.



LEGEND

- 90 TRAFFIC MOVEMENT VOLUME (VPH)
- (A) APPROACH LEVEL OF SERVICE
- LANE USAGE
- CONES

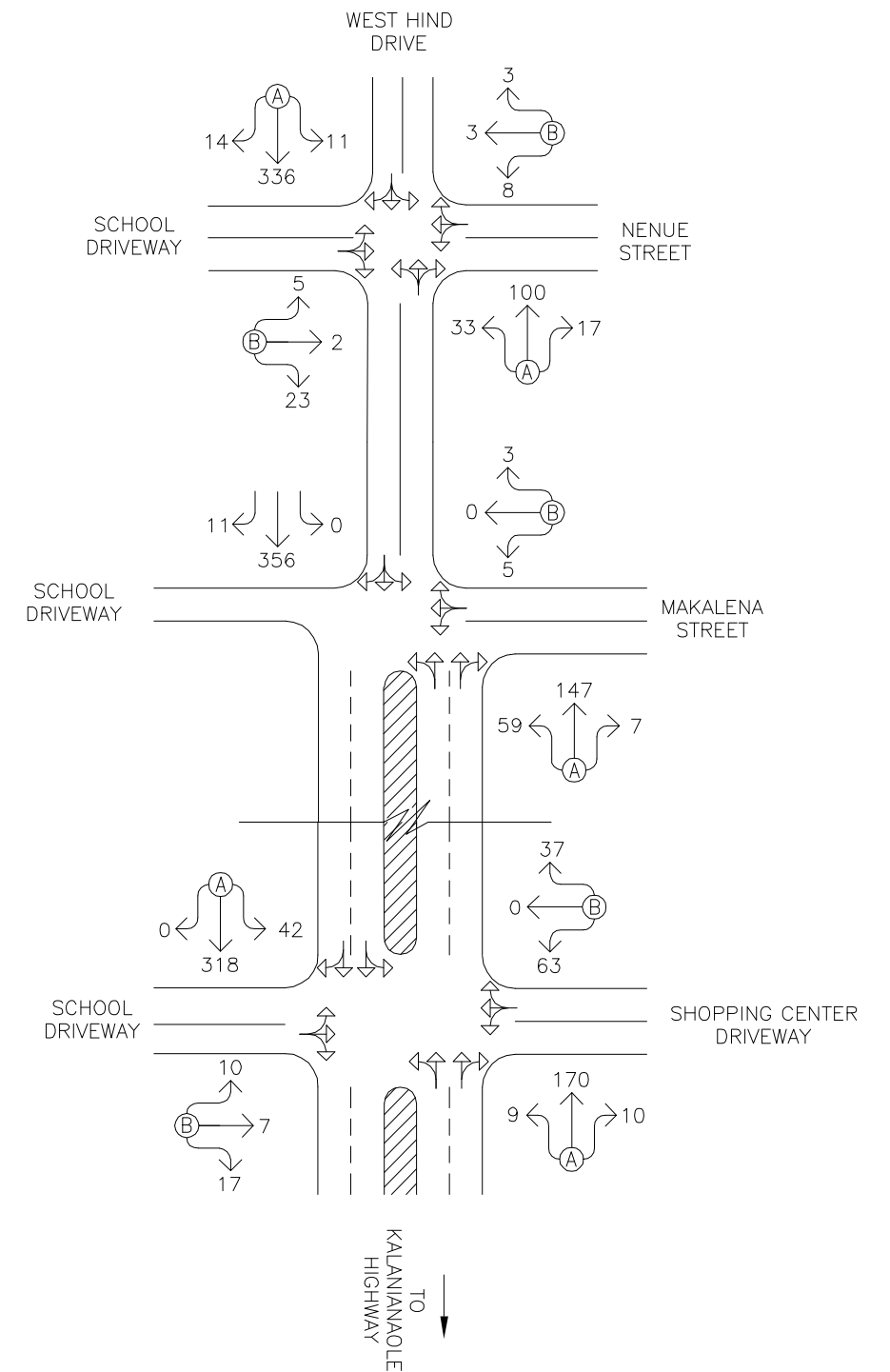
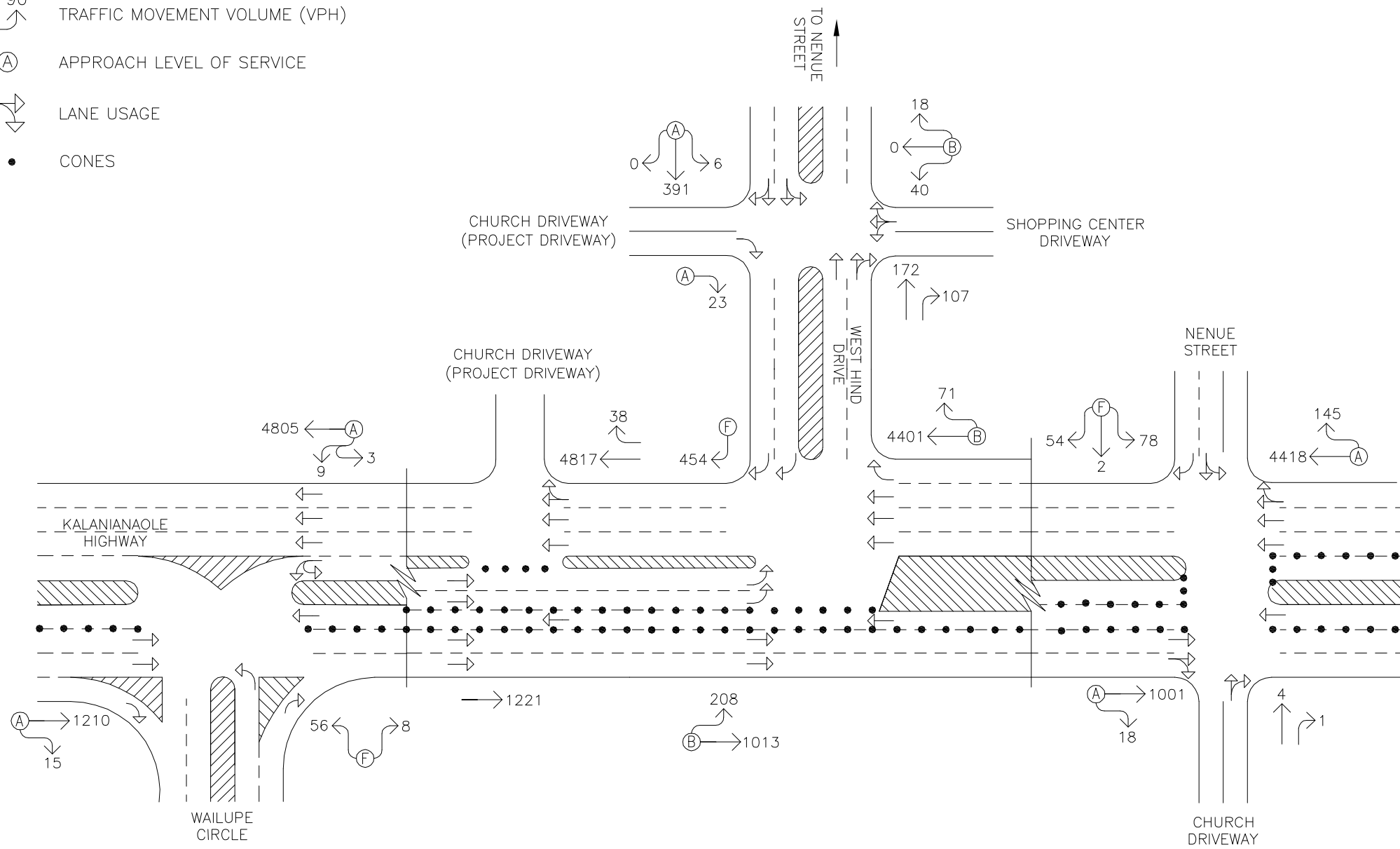

LONGS DRUGS AINA HAINA

YEAR 2015 AM PEAK PERIOD OF TRAFFIC WITH ALTERNATIVE 1

FIGURE

13





LEGEND

- 90 TRAFFIC MOVEMENT VOLUME (VPH)
- (A) APPROACH LEVEL OF SERVICE
- LANE USAGE

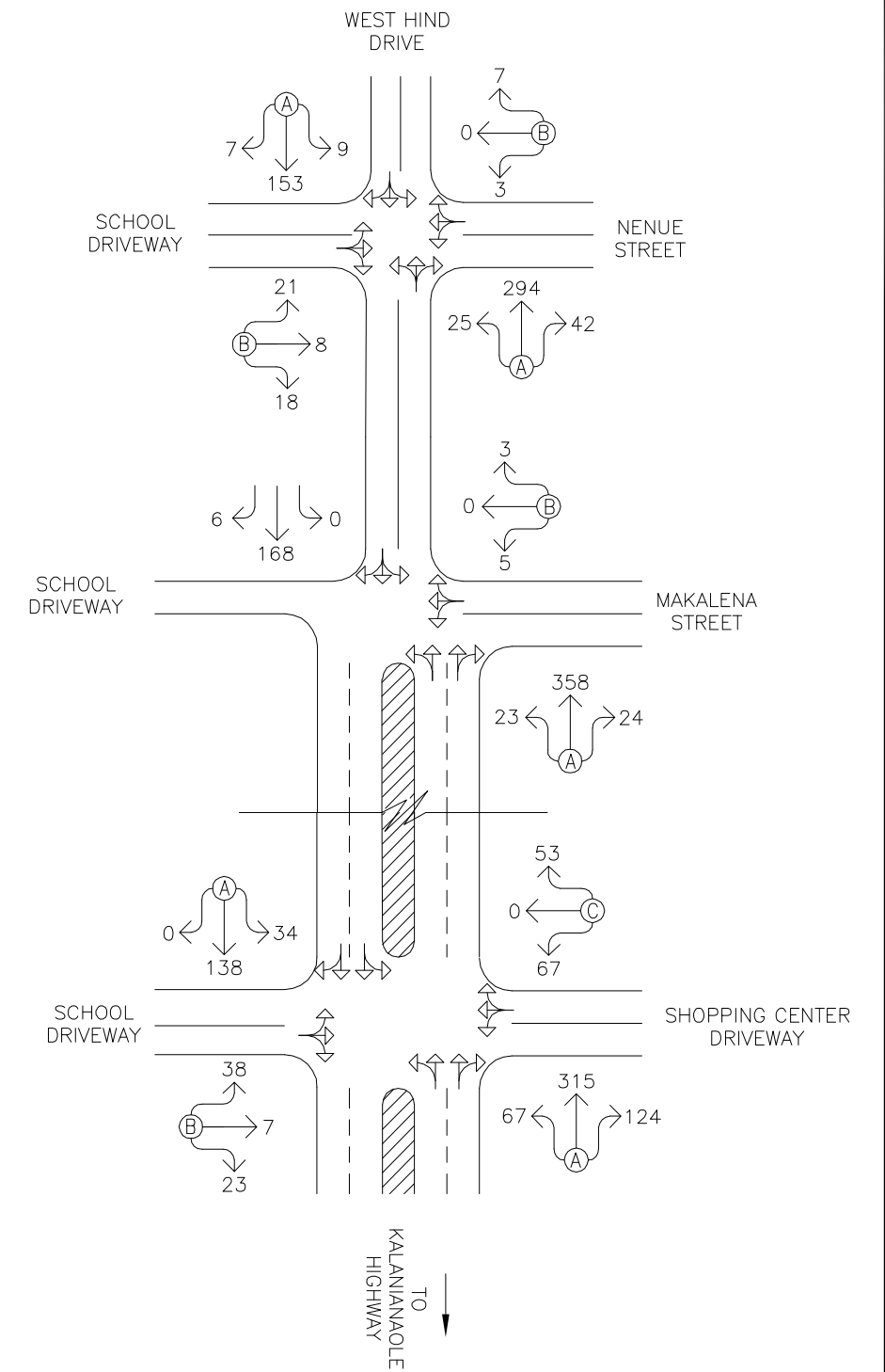
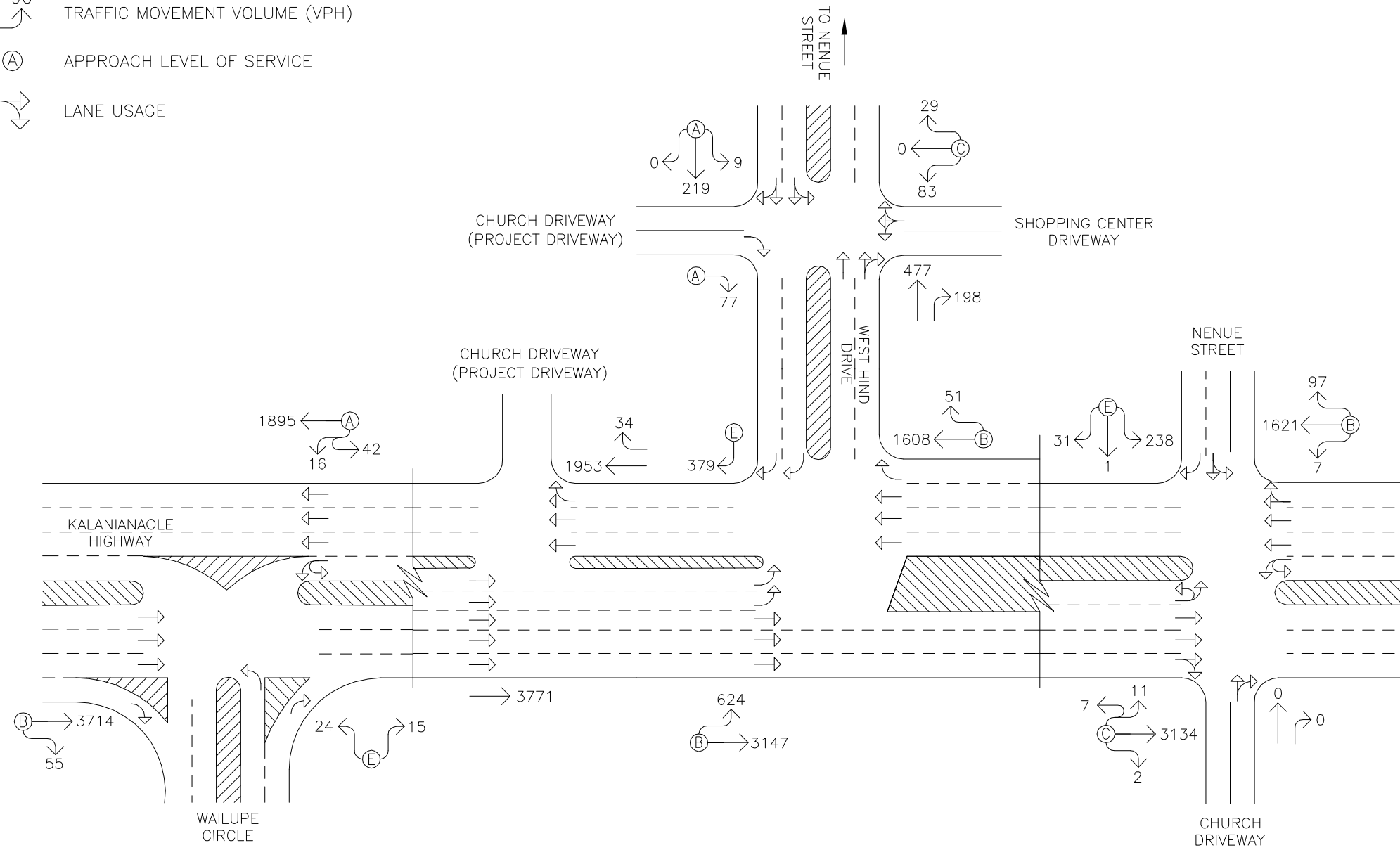

LONGS DRUGS AINA HAINA

YEAR 2015 PM PEAK PERIOD OF TRAFFIC WITH ALTERNATIVE 1

FIGURE

14





LEGEND

- 90 TRAFFIC MOVEMENT VOLUME (VPH)
- (A) APPROACH LEVEL OF SERVICE
- LANE USAGE
- CONES

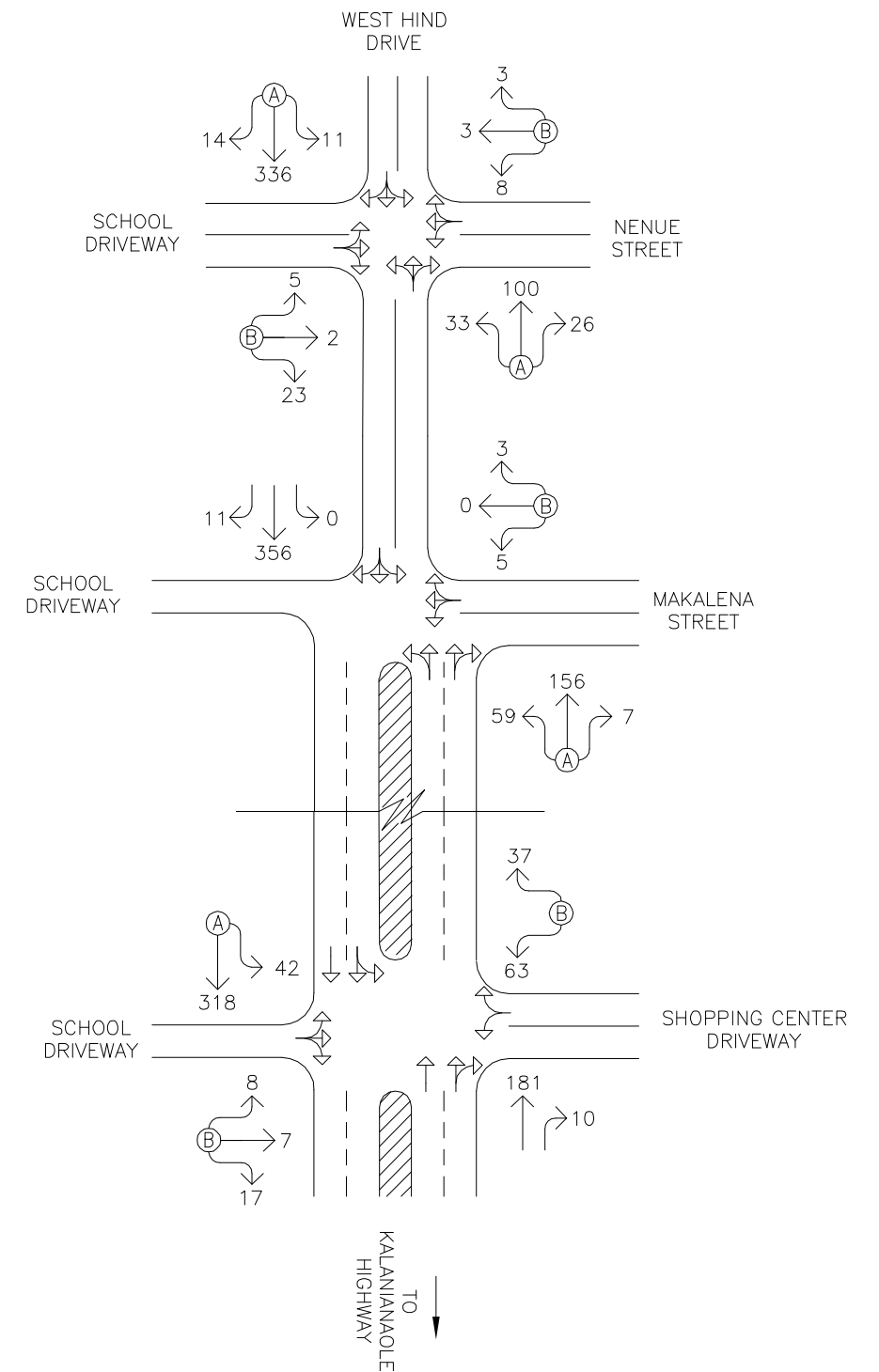
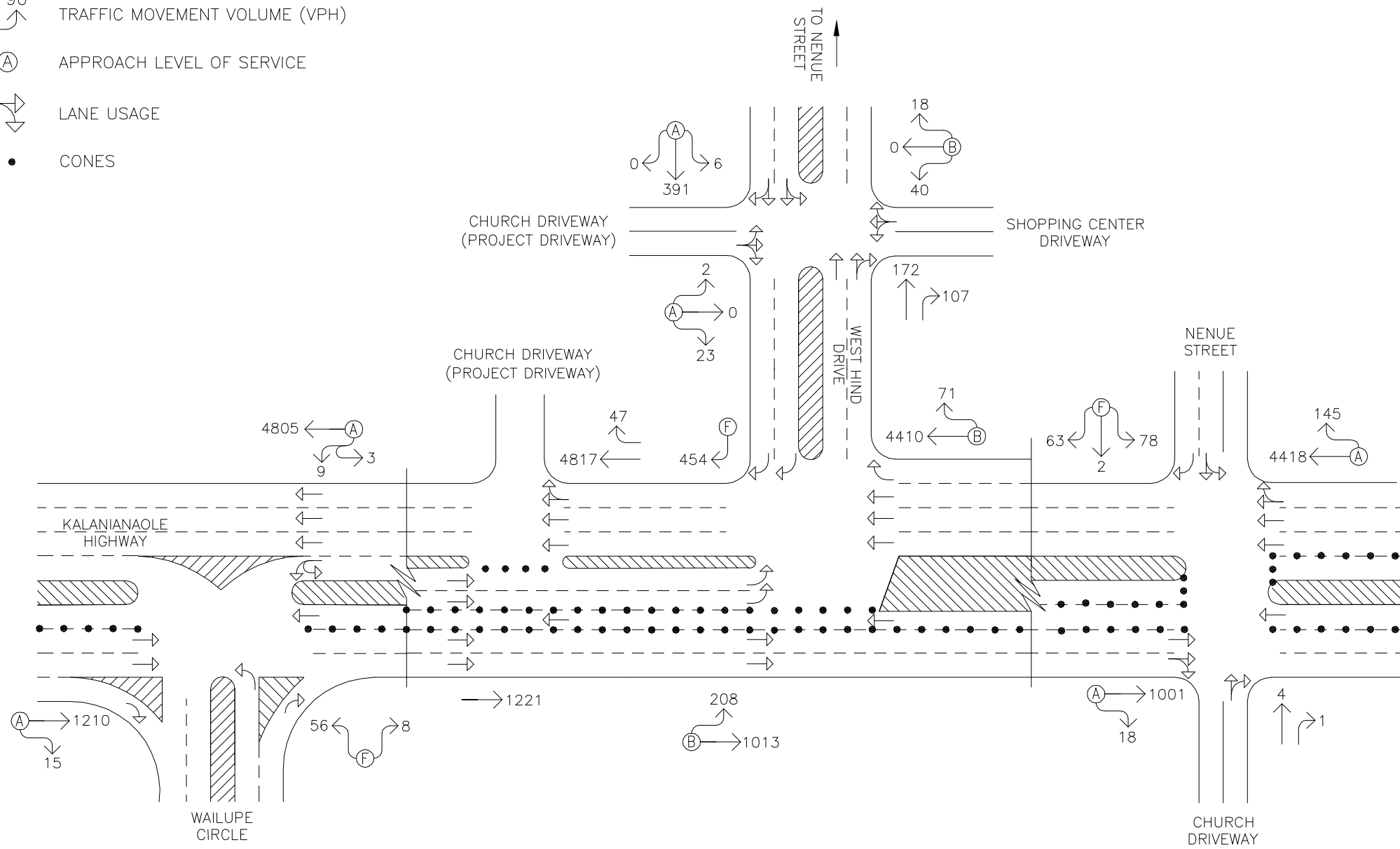

LONGS DRUGS AINA HAINA

YEAR 2015 AM PEAK PERIOD OF TRAFFIC WITH ALTERNATIVE 2

FIGURE

15





LEGEND

- 90 TRAFFIC MOVEMENT VOLUME (VPH)
- (A) APPROACH LEVEL OF SERVICE
- LANE USAGE

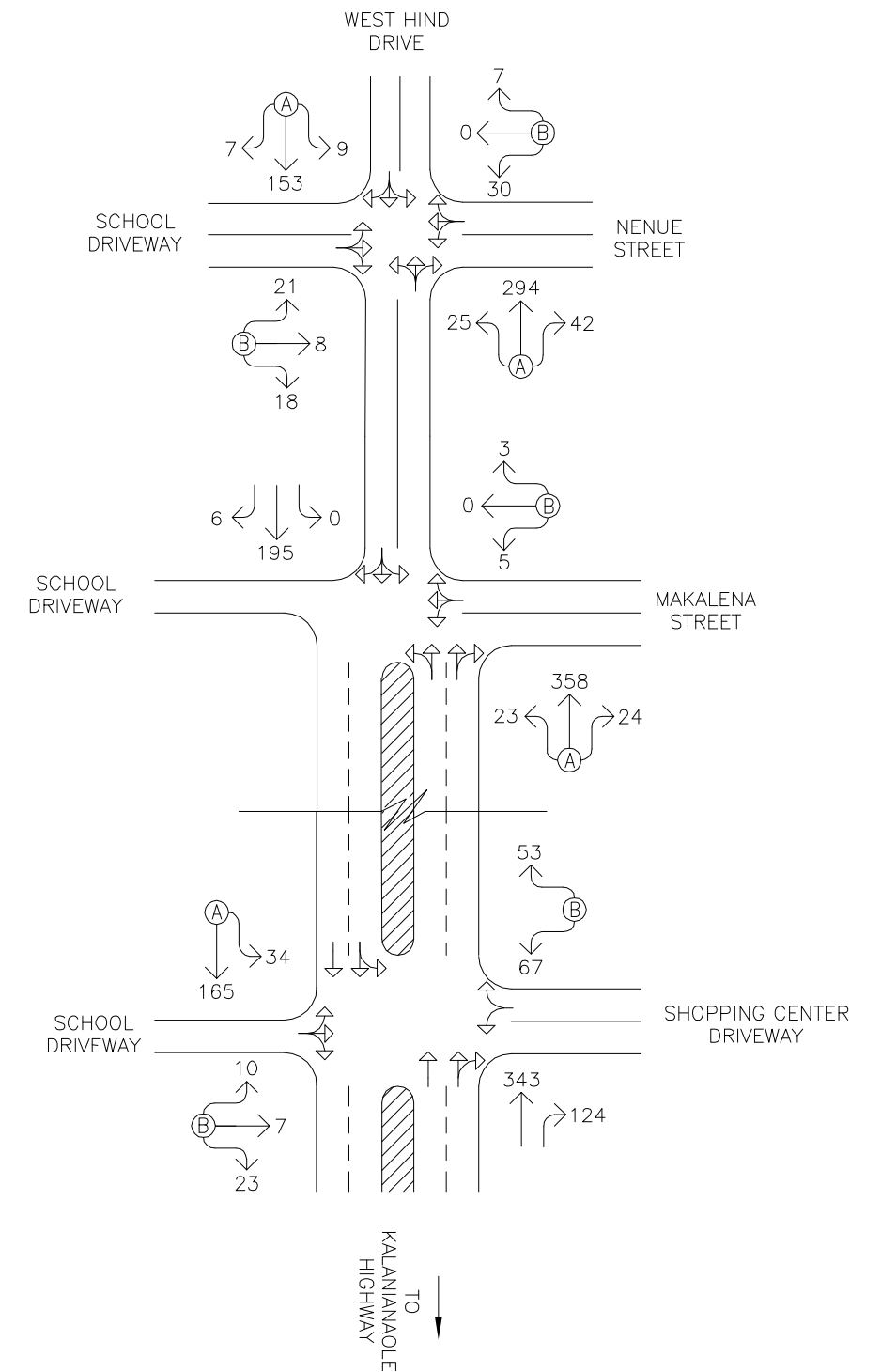
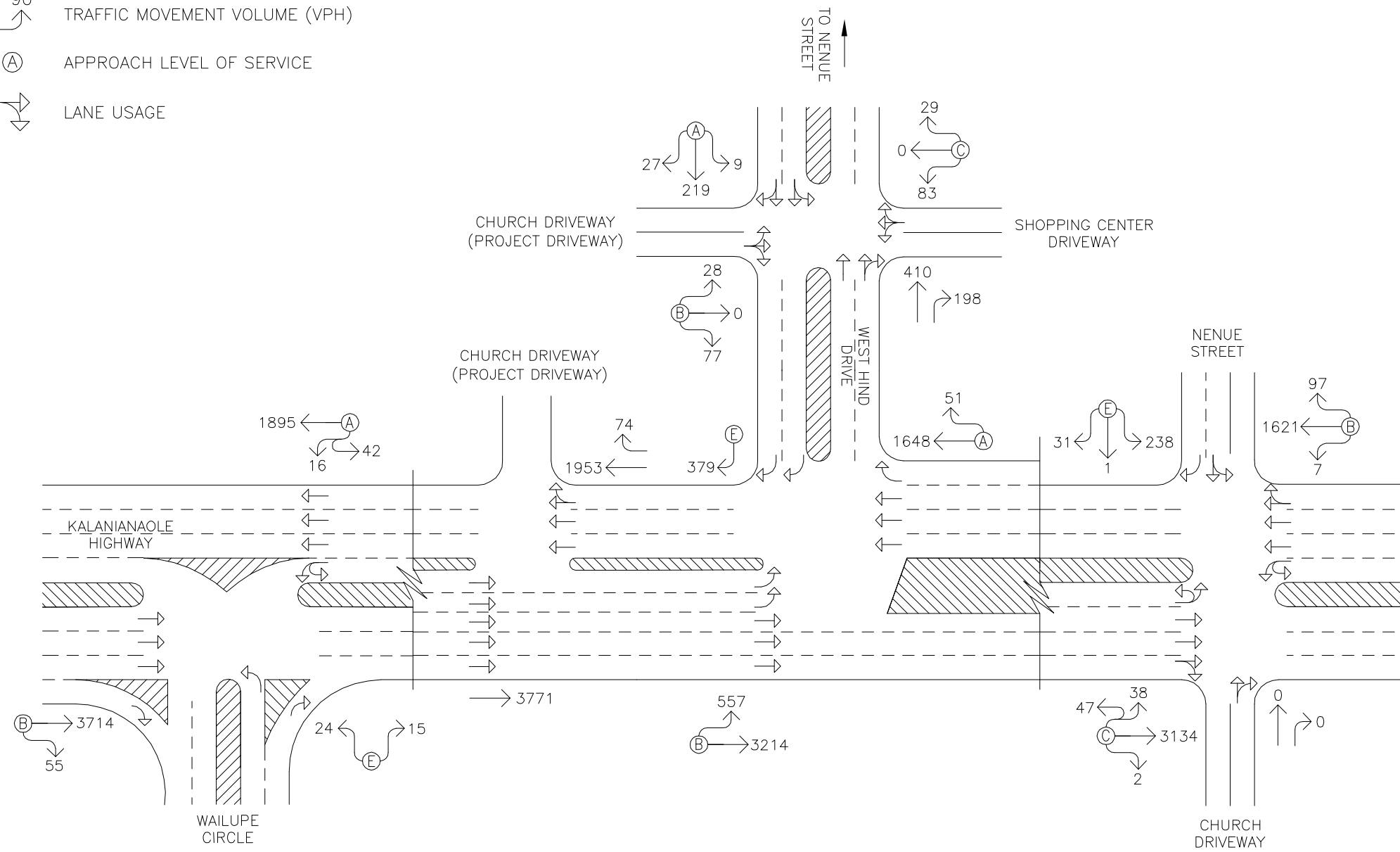

LONGS DRUGS AINA HAINA

YEAR 2015 PM PEAK PERIOD OF TRAFFIC WITH ALTERNATIVE 2

FIGURE

16





LEGEND

- 90 TRAFFIC MOVEMENT VOLUME (VPH)
- (A) APPROACH LEVEL OF SERVICE
- LANE USAGE
- CONES

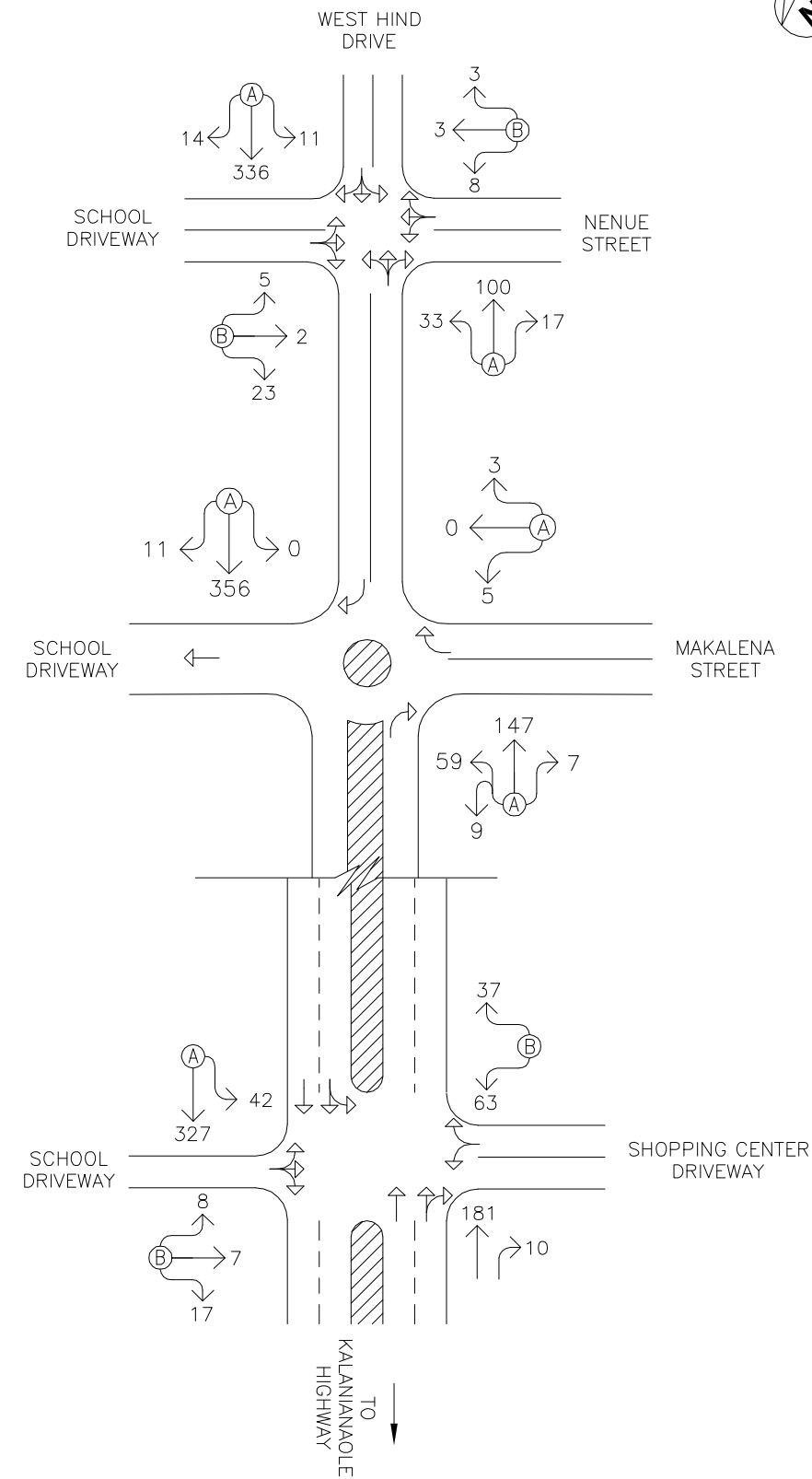
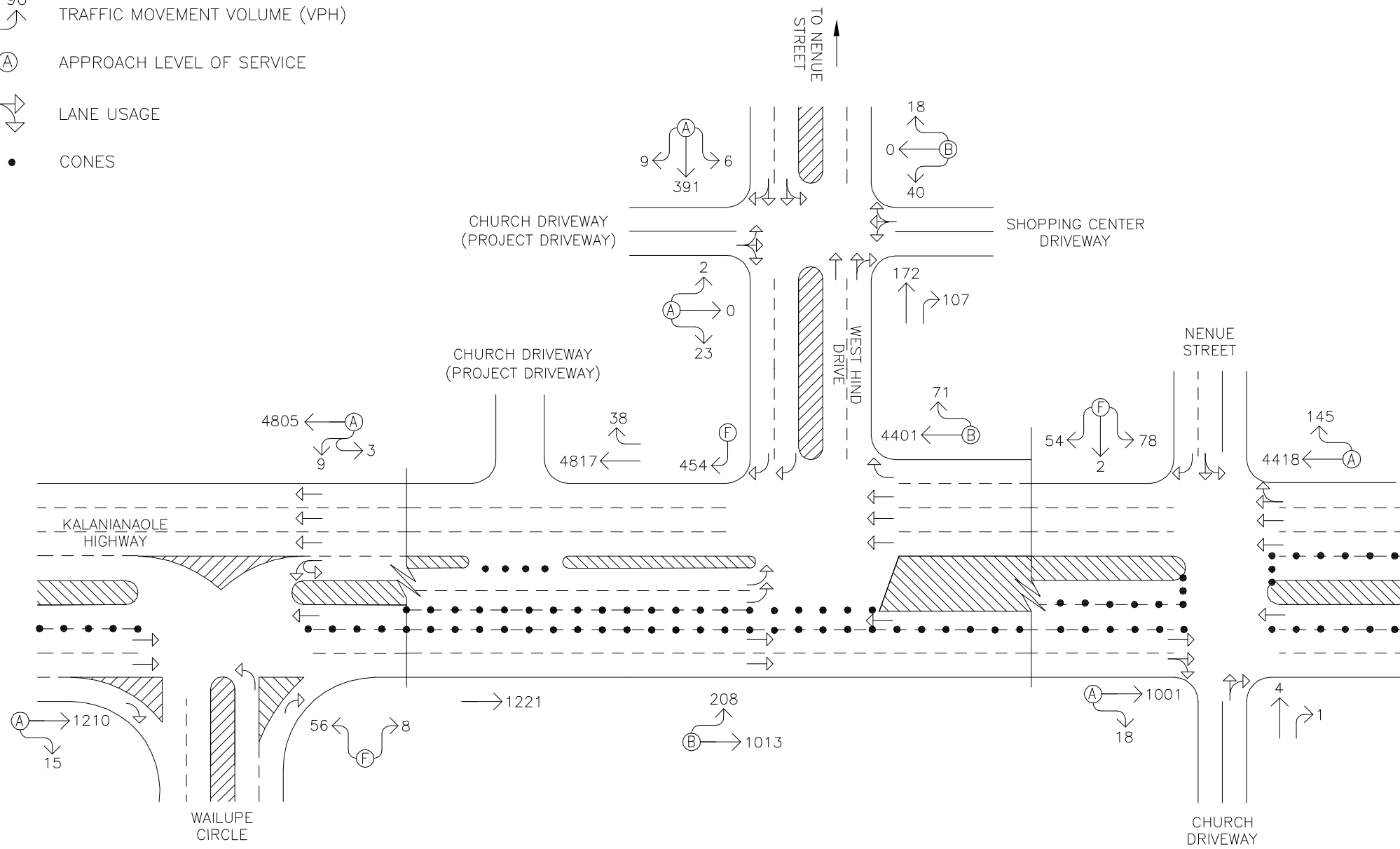

LONGS DRUGS AINA HAINA

YEAR 2015 AM PEAK PERIOD OF TRAFFIC WITH ALTERNATIVE 3

FIGURE

17





LEGEND

- 90 TRAFFIC MOVEMENT VOLUME (VPH)
- (A) APPROACH LEVEL OF SERVICE
- LANE USAGE

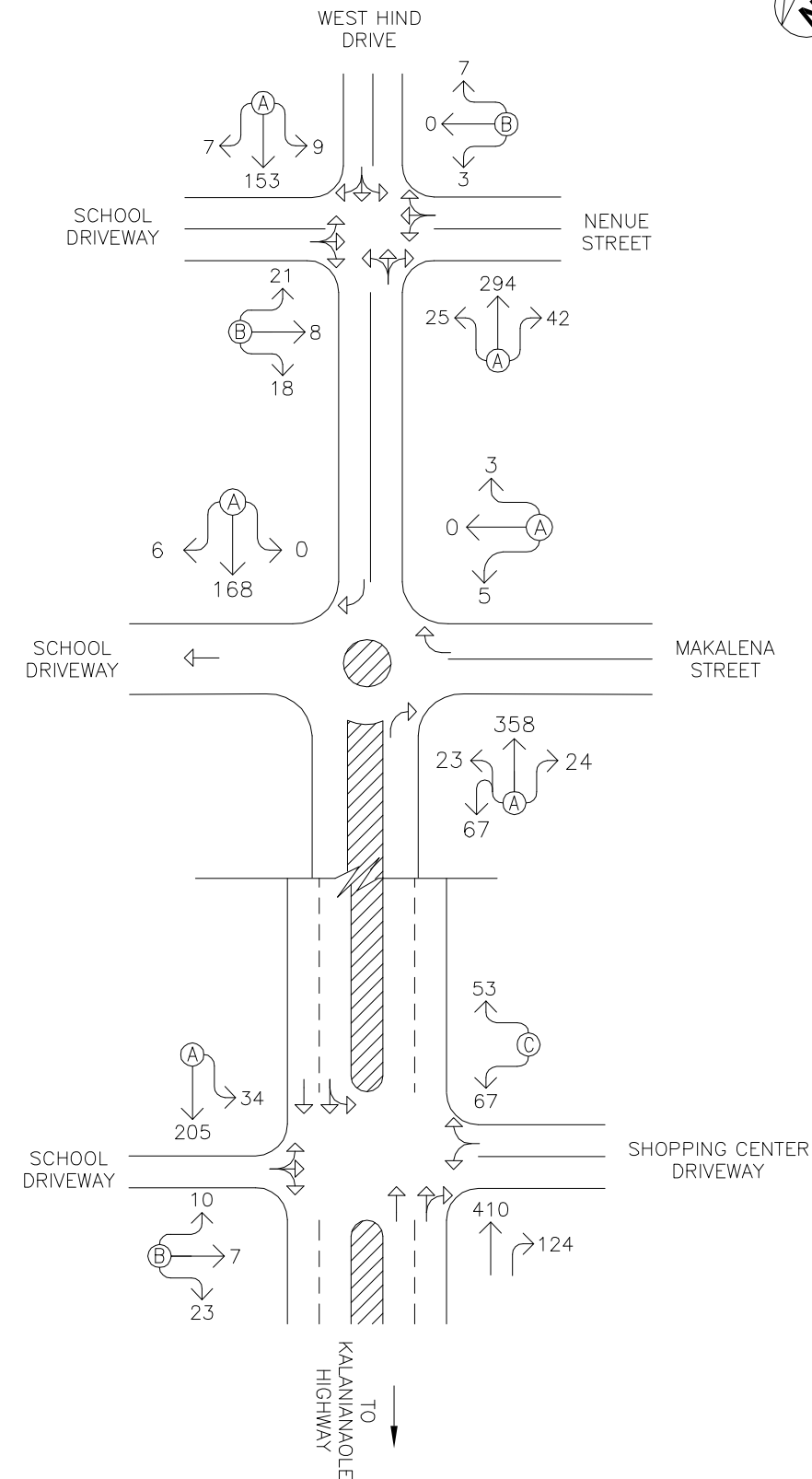
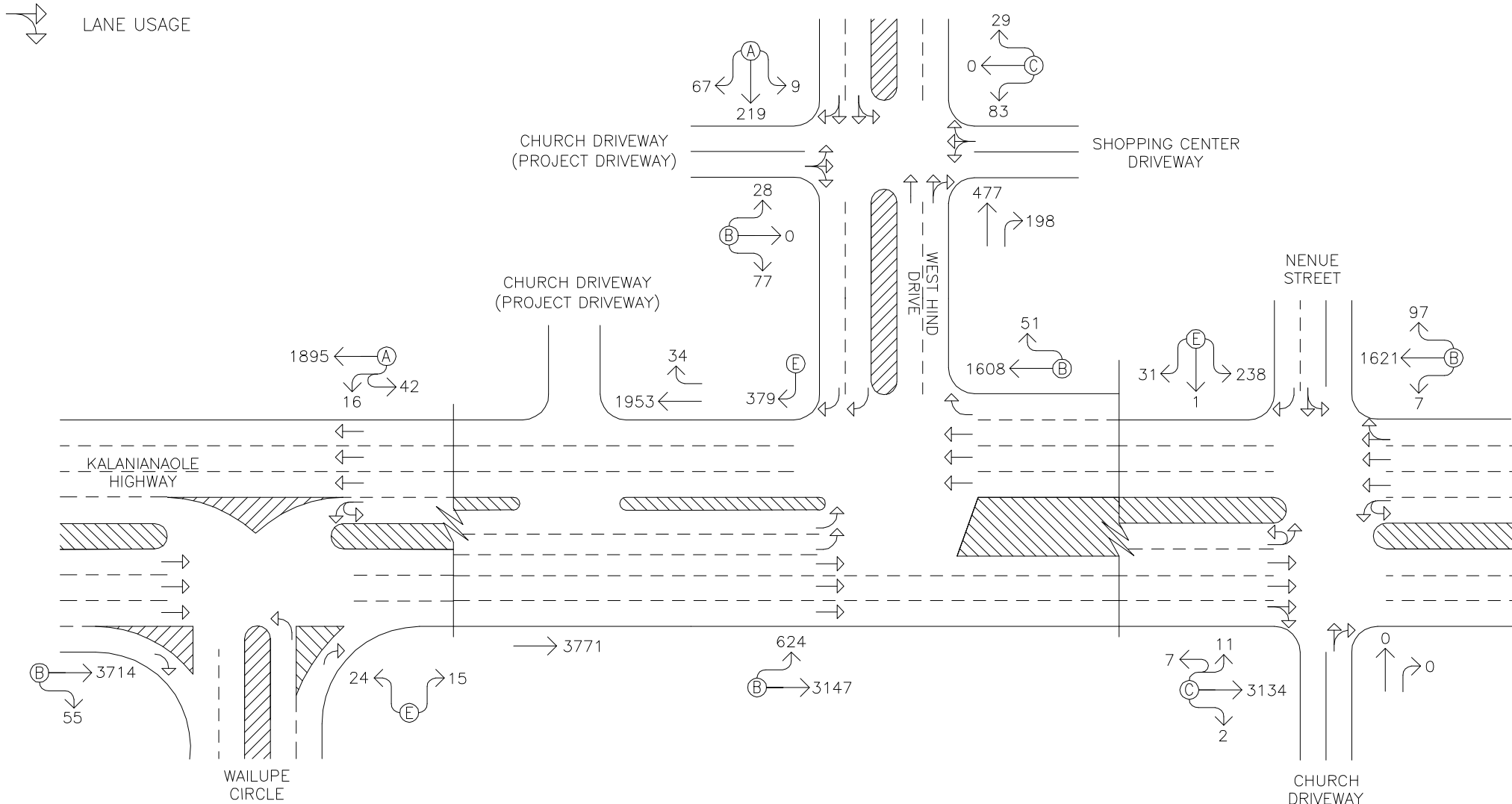

LONGS DRUGS AINA HAINA

YEAR 2015 PM PEAK PERIOD OF TRAFFIC WITH ALTERNATIVE 3

FIGURE

18



Table 3: Existing and Projected Year 2015 (Without and With Alternative 1) LOS Traffic Operating Conditions

Intersection	Approach/ Critical Movement	AM			PM		
		Exist	Year 2015		Exist	Year 2015	
			w/out Proj	w/ Alt 1		w/out Proj	w/ Alt 1
Kalaniana'ole Hwy/ Wailupe Cir	Eastbound	A	A	A	B	B	B
	Westbound	A	A	A	A	A	A
	Northbound	F	F	F	E	E	E
Kalaniana'ole Hwy/ West Hind Dr	Eastbound	B	B	B	B	B	B
	Westbound	B	B	B	A	A	B
	Southbound	F	F	F	E	E	E
West Hind Dr/ Project Dwy/ Shopping Center Dwy	Eastbound*	-	-	A	-	-	A
	Westbound	B	B	B	C	C	C
	Southbound	A	A	A	A	A	A
West Hind Dr/ School Dwy/ Shopping Center Dwy	Eastbound	B	B	B	B	B	B
	Westbound	B	B	B	B	B	C
	Northbound	-	-	A	-	-	A
	Southbound	A	A	A	A	A	A
West Hind Dr/ Makalena St	Westbound	B	B	B	B	B	B
	Northbound	A	A	A	A	A	A
West Hind Dr/ Nenu St	Eastbound	B	B	B	B	B	B
	Westbound	B	B	B	B	B	B
	Northbound	A	A	A	A	A	A
	Southbound	A	A	A	A	A	A
Kalaniana'ole Hwy/ Nenu St	Eastbound	A	A	A	C	C	C
	Westbound	A	A	A	B	B	B
	Southbound	F	F	F	E	E	E

*Project driveway (formerly the church driveway)

Traffic operations with the implementation of Alternative 1 for the Longs Drugs Aina Haina store are generally expected to remain similar to existing and without project conditions despite the addition of site-generated trips to the surrounding roadway network. Along Kalaniana'ole Highway, traffic operations for the highway approaches of the intersections with Wailupe Circle, West Hind Drive, and Nenu Street are expected to continue operating at LOS "B" or better during both

peak periods with the exception of the eastbound approach of the intersection with Nenu Street which is expected to continue operating at LOS “C” during the PM peak period. The side street approaches of these intersections are expected to continue operating at LOS “F” during the AM peak period and LOS “E” during the PM peak period. As previously discussed, the low levels of service along these side streets are primarily due to the long traffic signal cycle lengths along the highway. Along West Hind Drive, traffic operations at the other study intersections are expected to operate at LOS “C” or better during both peak periods.

B. Alternative 2

The Year 2015 cumulative AM and PM peak hour traffic conditions with the implementation of Alternative 2 for the Longs Drugs Aina Haina store are summarized in Table 4. The existing and projected Year 2015 (without project) operating conditions are provided for comparison purposes. LOS calculations are included in Appendix F.

Table 4: Existing and Projected Year 2015 (Without and With Alternative 2) LOS Traffic Operating Conditions

Intersection	Approach/ Critical Movement	AM			PM		
		Exist	Year 2015		Exist	Year 2015	
			w/out Proj	w/ Alt 2		w/out Proj	w/ Alt 2
Kalaniana'ole Hwy/ Wailupe Cir	Eastbound	A	A	A	B	B	B
	Westbound	A	A	A	A	A	A
	Northbound	F	F	F	E	E	E
Kalaniana'ole Hwy/ West Hind Dr	Eastbound	B	B	B	B	B	B
	Westbound	B	B	B	A	A	A
	Southbound	F	F	F	E	E	E
West Hind Dr/ Project Dwy/ Shopping Center Dwy	Eastbound*	-	-	A	-	-	B
	Westbound	B	B	B	C	C	C
	Southbound	A	A	A	A	A	A
West Hind Dr/ School Dwy/ Shopping Center Dwy	Eastbound	B	B	B	B	B	B
	Westbound	B	B	B	B	B	B
	Southbound	A	A	A	A	A	A

*Project driveway (formerly the church driveway)

Table 4: Existing and Projected Year 2015 (Without and With Alternative 2) LOS Traffic Operating Conditions (Cont'd)

Intersection	Approach/ Critical Movement	AM			PM		
		Exist	Year 2015		Exist	Year 2015	
			w/out Proj	w/ Alt 2		w/out Proj	w/ Alt 2
West Hind Dr/ Makalena St	Westbound	B	B	B	B	B	B
	Northbound	A	A	A	A	A	A
West Hind Dr/ Nenu St	Eastbound	B	B	B	B	B	B
	Westbound	B	B	B	B	B	B
	Northbound	A	A	A	A	A	A
	Southbound	A	A	A	A	A	A
Kalaniana'ole Hwy/ Nenu St	Eastbound	A	A	A	C	C	C
	Westbound	A	A	A	B	B	B
	Southbound	F	F	F	E	E	E

Traffic operations with the implementation of Alternative 2 for the Longs Drugs Aina Haina store are expected to remain similar to existing and without project conditions. Along Kalaniana'ole Highway, traffic operations for the highway approaches of the intersections with Wailupe Circle, West Hind Drive, and Nenu Street are expected to continue operating at LOS "B" or better during both peak periods with the exception of the eastbound approach of the intersection with Nenu Street which is expected to continue operating at LOS "C" during the PM peak period. The side street approaches of these intersections are expected to continue operating at LOS "F" during the AM peak period and LOS "E" during the PM peak period. As previously discussed, the low levels of service along these side streets are primarily due to the long traffic signal cycle lengths along the highway. Along West Hind Drive, traffic operations at the other study intersections are expected to continue operating at LOS "C" or better during both peak periods.

C. Alternative 3

The Year 2015 cumulative AM and PM peak hour traffic conditions with the implementation of Alternative 3 for the Longs Drugs Aina Haina store are summarized in Table 5. The intersection of West Hind Drive and Makalena Street is assumed to be modified to provide a traffic circle at that intersection. The existing

and projected Year 2015 (without project) operating conditions are provided for comparison purposes. LOS calculations are included in Appendix G.

Table 5: Existing and Projected Year 2015 (Without and With Alternative 3) LOS Traffic Operating Conditions

Intersection	Approach/ Critical Movement	AM			PM		
		Exist	Year 2015		Exist	Year 2015	
			w/out Proj	w/ Alt 3		w/out Proj	w/ Alt 3
Kalaniana'ole Hwy/ Wailupe Cir	Eastbound	A	A	A	B	B	B
	Westbound	A	A	A	A	A	A
	Northbound	F	F	F	E	E	E
Kalaniana'ole Hwy/ West Hind Dr	Eastbound	B	B	B	B	B	B
	Westbound	B	B	B	A	A	B
	Southbound	F	F	F	E	E	E
West Hind Dr/ Project Dwy/ Shopping Center Dwy	Eastbound*	-	-	A	-	-	B
	Westbound	B	B	B	C	C	C
	Southbound	A	A	A	A	A	A
West Hind Dr/ School Dwy/ Shopping Center Dwy	Eastbound	B	B	B	B	B	B
	Westbound	B	B	B	B	B	C
	Southbound	A	A	A	A	A	A
West Hind Dr/ Makalena St**	Westbound	B	B	A	B	B	A
	Northbound	A	A	A	A	A	A
	Southbound	-	-	A	-	-	A
West Hind Dr/ Nenu St	Eastbound	B	B	B	B	B	B
	Westbound	B	B	B	B	B	B
	Northbound	A	A	A	A	A	A
	Southbound	A	A	A	A	A	A
Kalaniana'ole Hwy/ Nenu St	Eastbound	A	A	A	C	C	C
	Westbound	A	A	A	B	B	B
	Southbound	F	F	F	E	E	E

*Project driveway (formerly the church driveway)

**Traffic circle implemented at intersection

Traffic operations with the implementation of Alternative 3 for the Longs Drugs Aina Haina store are generally expected to remain similar to existing and projected Year 2015 without project conditions. Along Kalaniana'ole Highway,

traffic operations for the highway approaches of the intersections with Wailupe Circle, West Hind Drive, and Nenu Street are expected to continue operating at LOS “B” or better during both peak periods with the exception of the eastbound approach of the intersection with Nenu Street which is expected to continue operating at LOS “C” during the PM peak period. The side street approaches of these intersections are expected to continue operating at LOS “F” during the AM peak period and LOS “E” during the PM peak period. As previously discussed, the low levels of service along these side streets are primarily due to the long traffic signal cycle lengths along the highway. Along West Hind Drive, traffic operations at the other study intersections are expected to continue operating at LOS “C” or better during both peak periods.

VI. RECOMMENDATIONS

Based on the analysis of the traffic data, the following are the recommendations of this study to be incorporated in the project design.

1. Maintain sufficient sight distance for motorists to safely enter and exit all project driveways.
2. Provide adequate on-site loading and off-loading service areas and prohibit off-site loading operations.
3. Provide adequate turn-around area for service, delivery, and refuse collection vehicles to maneuver on the project site to avoid vehicle-reversing maneuvers onto public roadways.
4. Provide sufficient turning radii at all project driveways to avoid vehicle encroachments to oncoming traffic lanes.
5. Coordinate with the City & County of Honolulu Department of Transportation Services to determine if modifications are required to the traffic signal timing along Kalanianaʻole Highway to alleviate existing and projected traffic conditions.
6. Maintain the existing turning restrictions at the project driveway off West Hind Drive. Currently, left-turn and U-turn traffic movements are prohibited for northbound vehicles and U-turn traffic movements are prohibited for southbound vehicles.
7. Update the Traffic Impact Report for the Longs Drugs Aina Haina store 6-9 months after opening to verify trip generation, trip distribution, and projected operating conditions.

The following are additional recommendations to be incorporated in the design of Alternative 1:

1. Modify the existing exit driveway for the adjacent Aina Haina Elementary School to accommodate the project driveway on the north side of the project site and allow two-way traffic flow between that driveway and West Hind Drive to the project site to accommodate the proposed left-turn bay. The layout and dimensions for this improvement should be determined during the design phase of the project.
2. Restrict turning movements at the project driveway off West Hind Drive to right-turn-in and right-turn-out movements.

The following are additional recommendations to be incorporated in the design of Alternative 3:

1. Construct a single-lane traffic circle at the intersection of West Hind Drive and Makalena Street. The layout and dimensions for this improvement should be determined during the design phase of the project.
2. Modify West Hind Drive south of Makalena Street to provide a transition from the single-lane traffic circle to the existing four-lane roadway cross section.

VII. CONCLUSION

The proposed project entails the renovation of an existing two-story church to provide a new Longs Drugs Aina Haina store with approximately 25,480 square feet of commercial space that is expected to include general merchandise and pharmacy services. In conjunction with the development of the proposed store, modifications are expected to an existing exit driveway for the adjacent Aina Haina Elementary School to accommodate a new access driveway on the north side of the project site. However, this new driveway requires coordination with the Department of Education and Hawaiian Telecom that may not be resolved within the timeframe of the proposed project. As such, two additional alternatives are currently under consideration. With the implementation of the aforementioned recommendations, the three alternatives for the proposed Longs Drugs Aina Haina store are not expected to have a significant impact on traffic operations in the project vicinity. Traffic operations at the study intersections are expected to continue operating at levels of service similar to existing and without project conditions. Although traffic operations are expected to be similar to without project conditions, the side streets at the study intersections along the highway currently operate at low levels of service and, as such, an update to the traffic study

is recommended to be prepared 6-9 months after the opening of the proposed store to verify projected conditions.

APPENDIX A

EXISTING TRAFFIC COUNT DATA

Wilson Okamoto Corporation

1907 S. Beretania Street, Suite 400
Honolulu, HI 96826

Counted By: DY, II
Counters: TU-0650, TU-0651
Weather: Clear

File Name : KaiWai AM
Site Code : 00000005
Start Date : 9/9/2014
Page No : 1

Groups Printed- Unshifted

Start Time	Southbound			Kalaniahoale Highway Westbound			Waiiue Circle Northbound			Kalaniahoale Highway Eastbound			App. Total	Int. Total			
	App. Total	Left	Thru	Right	Peds	App. Total	Left	Thru	Right	Peds	App. Total	Left			Thru	Right	Peds
06:00 AM	0	4	778	0	0	782	3	0	2	2	7	0	128	2	0	130	919
06:15 AM	0	2	1050	0	0	1052	12	0	1	0	13	0	223	3	0	226	1291
06:30 AM	0	1	1243	0	0	1244	18	0	1	0	19	0	217	2	0	219	1482
06:45 AM	0	1	1304	0	0	1305	14	0	3	0	17	0	265	5	0	270	1592
Total	0	8	4375	0	0	4383	47	0	7	2	56	0	833	12	0	845	5284
07:00 AM	0	4	1173	0	0	1177	15	0	2	0	17	0	312	4	0	316	1510
07:15 AM	0	3	1006	0	0	1009	9	0	2	2	13	0	383	4	0	387	1409
07:30 AM	0	2	851	0	0	853	9	0	4	1	14	0	440	6	1	447	1314
07:45 AM	0	2	889	0	0	891	6	0	4	2	12	0	513	2	0	515	1418
Total	0	11	3919	0	0	3930	39	0	12	5	56	0	1648	16	1	1665	5651
08:00 AM	0	0	998	0	0	998	10	0	2	0	12	0	480	12	1	493	1503
08:15 AM	0	2	797	0	0	799	14	0	4	1	19	0	412	11	0	423	1241
08:30 AM	0	2	652	0	0	654	10	0	1	3	14	0	419	6	0	425	1093
08:45 AM	0	4	682	0	0	686	7	0	3	1	11	0	428	9	0	437	1134
Total	0	8	3129	0	0	3137	41	0	10	5	56	0	1739	38	1	1778	4971
Grand Total	0	27	11423	0	0	11450	127	0	29	12	168	0	4220	66	2	4288	15906
Approch %	0	0.2	99.8	0	0	72	75.6	0	17.3	7.1	1.1	0	98.4	1.5	0	27	
Total %	0	0.2	71.8	0	0	72	0.8	0	0.2	0.1	1.1	0	26.5	0.4	0	27	

Start Time	Southbound			Kalaniahoale Highway Westbound			Waiiue Circle Northbound			Kalaniahoale Highway Eastbound			App. Total	Int. Total			
	App. Total	Left	Thru	Right	Peds	App. Total	Left	Thru	Right	Peds	App. Total	Left			Thru	Right	Peds
06:30 AM	0	0	1	1243	0	1244	18	0	0	1	19	0	217	2	0	219	1482
06:45 AM	0	0	1	1304	0	1305	14	0	0	3	17	0	265	5	0	270	1592
07:00 AM	0	0	4	1173	0	1177	15	0	2	2	17	0	312	4	0	316	1510
07:15 AM	0	0	3	1006	0	1009	9	0	2	2	11	0	383	4	0	387	1407
Total Volume	0	0	9	4726	0	4735	56	0	8	8	64	0	1177	15	0	1192	5991
% App. Total	.000	0.2	99.8	.906	.000	.907	87.5	0	12.5	6.67	.842	0	98.7	1.3	0	.770	.941
PHF	.000	.563	.906	.000	.907	.907	.778	.000	.667	.750	.842	.000	.768	.750	.770	.770	.941

Peak Hour Analysis From 06:00 AM to 08:45 AM - Peak 1 of 1
Peak Hour for Entire Intersection Begins at 06:30 AM

Wilson Okamoto Corporation
 1907 S. Beretania Street, Suite 400
 Honolulu, HI 96826

Counted By: DY, II
 Counters: TU-0650, TU-0651
 Weather: Clear

File Name : KalWai AM U-Turn
 Site Code : 00000005
 Start Date : 9/9/2014
 Page No : 1

Start Time	Groups Printed- Unshifted											
	Southbound			Westbound			Northbound			Kalaniana'ole Highway		
	App. Total	App. Total	App. Total	App. Total	App. Total	App. Total	Left	Thru	Right	Peds	App. Total	Int. Total
06:00 AM	0	0	0	0	0	0	0	0	0	0	0	0
06:15 AM	0	0	0	0	0	0	0	0	0	0	0	0
06:30 AM	0	0	0	0	0	0	0	0	0	0	0	0
06:45 AM	0	0	0	0	0	0	0	0	0	0	0	0
Total	0	0	0	0	0	0	0	0	0	0	0	0
07:00 AM	0	0	0	0	0	0	0	0	0	0	0	0
07:15 AM	0	0	0	0	0	0	0	0	0	0	0	0
07:30 AM	0	0	0	0	0	0	13	0	0	0	13	13
07:45 AM	0	0	0	0	0	0	7	0	0	0	7	7
Total	0	0	0	0	0	0	20	0	0	0	20	20
08:00 AM	0	0	0	0	0	0	1	0	0	0	1	1
08:15 AM	0	0	0	0	0	0	4	0	0	0	4	4
08:30 AM	0	0	0	0	0	0	4	0	0	0	4	4
08:45 AM	0	0	0	0	0	0	1	0	0	0	1	1
Total	0	0	0	0	0	0	10	0	0	0	10	10
Grand Total	0	0	0	0	0	0	30	0	0	0	30	30
Apprch %							100	0	0	0	100	
Total %							100	0	0	0	100	

Start Time	Kalaniana'ole Highway											
	Southbound			Westbound			Northbound			Left = U-Turn Thru Contr-Flow Lane Eastbound		
	App. Total	App. Total	App. Total	App. Total	App. Total	App. Total	Left	Thru	Right	Peds	App. Total	Int. Total
07:30 AM	0	0	0	0	0	0	13	0	0	0	13	13
07:45 AM	0	0	0	0	0	0	7	0	0	0	7	7
08:00 AM	0	0	0	0	0	0	1	0	0	0	1	1
08:15 AM	0	0	0	0	0	0	4	0	0	0	4	4
Total Volume	0	0	0	0	0	0	25	0	0	0	25	25
% App. Total							100	0	0	0	100	
PHF							.481	.000	.000	.000	.481	.481

Peak Hour Analysis From 06:00 AM to 08:45 AM - Peak 1 of 1
 Peak Hour for Entire Intersection Begins at 07:30 AM

Wilson Okamoto Corporation

1907 S. Beretania Street, Suite 400
Honolulu, HI 96826

Counted By: DY, II
Counters: TU-0651, TU-0650
Weather: Clear

File Name : KaiWai PM
Site Code : 00000005
Start Date : 9/9/2014
Page No : 1

Groups Printed- Unshifted

Start Time	Southbound				Kalaniana'ole Highway Westbound				Waiupe Circle Northbound				Kalaniana'ole Highway Eastbound				App. Total	Int. Total					
	App. Total	Left	Thru	Right	Thru	Right	Peds	App. Total	Left	Thru	Right	Peds	App. Total	Left	Thru	Right			Peds	App. Total	Left	Thru	Right
03:00 PM	0	14	501	0	2	517	6	0	5	1	12	0	668	5	0	673	1202	0	0	0	0	0	0
03:15 PM	0	1	519	0	1	521	8	0	4	1	13	0	779	9	0	788	1322	0	0	0	0	0	0
03:30 PM	0	5	437	0	0	442	5	0	3	0	8	0	791	8	0	799	1249	0	0	0	0	0	0
03:45 PM	0	2	508	0	0	510	6	0	7	0	13	0	807	15	0	822	1345	0	0	0	0	0	0
Total	0	22	1965	0	3	1990	25	0	19	2	46	0	3045	37	0	3082	5118	0	0	0	0	0	0
04:00 PM	0	3	408	0	2	413	5	0	4	0	9	0	884	9	0	893	1315	0	0	0	0	0	0
04:15 PM	0	0	456	0	0	456	6	0	3	0	9	0	820	11	0	831	1296	0	0	0	0	0	0
04:30 PM	0	7	510	0	0	517	11	0	4	0	15	0	890	14	0	904	1436	0	0	0	0	0	0
04:45 PM	0	2	426	0	0	428	5	0	2	0	7	0	810	12	0	822	1257	0	0	0	0	0	0
Total	0	12	1800	0	2	1814	27	0	13	0	40	0	3404	46	0	3450	5304	0	0	0	0	0	0
05:00 PM	0	4	427	0	1	432	3	0	3	1	7	0	855	10	0	865	1304	0	0	0	0	0	0
05:15 PM	0	3	534	0	0	537	4	0	1	0	5	0	907	17	0	924	1466	0	0	0	0	0	0
05:30 PM	0	2	432	0	0	434	5	0	4	0	9	0	860	10	0	870	1313	0	0	0	0	0	0
05:45 PM	0	7	434	0	0	441	12	0	7	0	19	0	951	18	0	969	1429	0	0	0	0	0	0
Total	0	16	1827	0	1	1844	24	0	15	1	40	0	3573	55	0	3628	5512	0	0	0	0	0	0
Grand Total	0	50	5592	0	6	5648	76	0	47	3	126	0	10022	138	0	10160	15934	0	0	0	0	0	0
Approch % Total %	0	0.9	99	0	0.1	35.4	60.3	0	37.3	2.4	0.8	0	98.6	1.4	0	63.8		0	0	0	0	0	0
		0.3	35.1	0	0		0.5	0	0.3	0		0	62.9	0.9	0								

Start Time	Southbound				Kalaniana'ole Highway Westbound				Waiupe Circle Northbound				Kalaniana'ole Highway Eastbound				App. Total	Int. Total					
	App. Total	Left	Thru	Right	Thru	Right	Peds	App. Total	Left	Thru	Right	Peds	App. Total	Left	Thru	Right			Peds	App. Total	Left	Thru	Right
05:00 PM	0	0	4	427	0	431	3	0	0	3	6	0	855	10	0	865	1302	0	0	0	0	0	0
05:15 PM	0	0	3	534	0	537	4	0	0	1	5	0	907	17	0	924	1466	0	0	0	0	0	0
05:30 PM	0	0	2	432	0	434	5	0	4	0	9	0	860	10	0	870	1313	0	0	0	0	0	0
05:45 PM	0	0	7	434	0	441	12	0	7	0	19	0	951	18	0	969	1429	0	0	0	0	0	0
Total Volume	0	0	16	1827	0	1843	24	0	0	15	39	0	3573	55	0	3628	5510	0	0	0	0	0	0
% App. Total PHF	.000	.571	.855	.000	.858	.513	.500	.000	.536	.764	.936	.940	.939	1.5	.936								

Peak Hour Analysis From 03:00 PM to 05:45 PM - Peak 1 of 1
Peak Hour for Entire Intersection Begins at 05:00 PM

Wilson Okamoto Corporation
 1907 S. Beretania Street, Suite 400
 Honolulu, HI 96826

Counted By: DY, II
 Counters: TU-0651, TU-0650
 Weather: Clear

File Name : KaiWai PM - U-Turns
 Site Code : 00000005
 Start Date : 9/9/2014
 Page No : 1

Start Time	Groups Printed- Unshifted											
	Southbound			Westbound			Northbound			Kalaniana'ole Highway		
	App. Total	App. Total	App. Total	App. Total	App. Total	App. Total	Left	Thru	Right	Peds	App. Total	Int. Total
03:00 PM	0	0	0	0	0	0	6	0	0	0	6	6
03:15 PM	0	0	0	0	0	0	6	0	0	0	6	6
03:30 PM	0	0	0	0	0	0	6	0	0	0	6	6
03:45 PM	0	0	0	0	0	0	2	0	0	0	2	2
Total	0	0	0	0	0	0	20	0	0	0	20	20
04:00 PM	0	0	0	0	0	0	5	0	0	0	5	5
04:15 PM	0	0	0	0	0	0	3	0	0	0	3	3
04:30 PM	0	0	0	0	0	0	5	0	0	0	5	5
04:45 PM	0	0	0	0	0	0	2	0	0	0	2	2
Total	0	0	0	0	0	0	15	0	0	0	15	15
05:00 PM	0	0	0	0	0	0	2	0	0	0	2	2
05:15 PM	0	0	0	0	0	0	2	0	0	0	2	2
05:30 PM	0	0	0	0	0	0	5	0	0	0	5	5
05:45 PM	0	0	0	0	0	0	7	0	0	0	7	7
Total	0	0	0	0	0	0	16	0	0	0	16	16
Grand Total	0	0	0	0	0	0	51	0	0	0	51	51
Apprch %							100	0	0	0	100	
Total %							100	0	0	0	100	

Start Time	Kalaniana'ole Highway											
	Southbound			Westbound			Northbound			Left = U-Turns Eastbound		
	App. Total	App. Total	App. Total	App. Total	App. Total	App. Total	Left	Thru	Right	Peds	App. Total	Int. Total
03:00 PM	0	0	0	0	0	0	6	0	0	0	6	6
03:15 PM	0	0	0	0	0	0	6	0	0	0	6	6
03:30 PM	0	0	0	0	0	0	6	0	0	0	6	6
03:45 PM	0	0	0	0	0	0	2	0	0	0	2	2
Total Volume	0	0	0	0	0	0	20	0	0	0	20	20
% App. Total							100	0	0	0	100	
PHF	.000	.000	.000	.000	.000	.000	.833	.000	.000	.000	.833	.833

Peak Hour Analysis From 03:00 PM to 05:45 PM - Peak 1 of 1
 Peak Hour for Entire Intersection Begins at 03:00 PM

Wilson Okamoto Corporation

1907 S. Beretania Street, Suite 400

Honolulu, HI 96826

Counted By:GC, RJ

Counter:D4-5671, D4-5675

Weather:Clear

File Name : KaiWHind AM

Site Code : 00000004

Start Date : 9/9/2014

Page No : 1

Groups Printed- Unshifted

Start Time	West Hind Drive Southbound				Kalaniana'ole Highway Westbound				Kalaniana'ole Highway Eastbound				App. Total	Int. Total				
	Left	Thru	Right	Peds	Left	Thru	Right	Peds	Left	Thru	Right	Peds			Left	Thru	Right	Peds
06:00 AM	0	0	81	0	0	702	3	2	2	0	107	0	21	107	0	0	128	916
06:15 AM	0	0	107	0	0	942	8	2	2	0	178	0	40	178	0	0	218	1277
06:30 AM	0	0	129	0	0	1111	14	0	0	0	180	0	48	180	0	0	228	1482
06:45 AM	0	0	117	0	0	1169	10	0	0	0	229	0	40	229	0	0	269	1565
Total	0	0	434	0	434	3924	35	4	4	3963	694	0	149	694	0	0	843	5240
07:00 AM	0	0	95	0	0	1085	17	3	3	0	252	0	46	252	0	0	298	1498
07:15 AM	0	0	90	1	0	910	30	3	3	0	328	0	65	328	0	0	393	1427
07:30 AM	0	0	116	2	0	750	48	4	4	0	352	0	112	352	0	0	464	1384
07:45 AM	0	0	121	2	0	769	79	1	1	0	394	0	88	394	0	0	482	1454
Total	0	0	422	5	427	3514	174	11	11	3699	1326	0	311	1326	0	0	1637	5763
08:00 AM	0	0	142	33	175	855	25	33	33	0	384	0	113	384	0	0	497	1585
08:15 AM	0	0	104	2	106	687	18	0	0	0	348	0	90	348	0	0	438	1249
08:30 AM	0	0	83	34	117	567	16	29	29	0	353	0	86	353	0	0	439	1168
08:45 AM	0	0	92	0	92	585	13	0	0	0	367	0	73	367	0	0	440	1130
Total	0	0	421	69	490	2694	72	62	62	2828	1452	0	362	1452	0	0	1814	5132
Grand Total	0	0	1277	74	1351	10132	281	77	77	10490	3472	0	822	3472	0	0	4294	16135
Approch %	0	0	94.5	5.5	8.4	96.6	2.7	0.7	0.7	19.1	80.9	0	5.1	21.5	0	0	26.6	
Total %	0	0	7.9	0.5	8.4	62.8	1.7	0.5	0.5	65	21.5	0	5.1	21.5	0	0	26.6	

Start Time	West Hind Drive Southbound				Kalaniana'ole Highway Westbound				Kalaniana'ole Highway Eastbound				App. Total	Int. Total				
	Left	Thru	Right	Peds	Left	Thru	Right	Peds	Left	Thru	Right	Peds			Left	Thru	Right	Peds
06:30 AM	0	0	129	0	129	1111	14	14	14	0	180	0	48	180	0	0	228	1482
06:45 AM	0	0	117	0	117	1169	10	10	10	0	229	0	40	229	0	0	269	1565
07:00 AM	0	0	95	0	95	1085	17	17	17	0	252	0	46	252	0	0	298	1495
07:15 AM	0	0	90	0	90	910	30	30	30	0	328	0	65	328	0	0	393	1423
Total Volume	0	0	431	0	431	4275	71	71	71	0	989	0	199	989	0	0	1188	5965
% App. Total	.000	.000	.835	.000	.835	.914	.592	1.6	1.6	0.000	.754	.000	.765	.754	.000	.000	.756	.953

Peak Hour Analysis From 06:00 AM to 08:45 AM - Peak 1 of 1

Peak Hour for Entire Intersection Begins at 06:30 AM

Wilson Okamoto Corporation

1907 S. Beretania Street, Suite 400
Honolulu, HI 96826

Counted By: GC, RJ
Counter: D4-5671, D4-5675
Weather: Clear

File Name : KaiWHind PM
Site Code : 00000004
Start Date : 9/9/2014
Page No : 1

Groups Printed- Unshifted

Start Time	West Hind Drive Southbound					Kalaniana'ole Highway Westbound					Kalaniana'ole Highway Eastbound					Int. Total
	Left	Thru	Right	Peds	App. Total	Left	Thru	Right	Peds	App. Total	Left	Thru	Right	Peds	App. Total	
						Northbound										
03:00 PM	0	0	90	5	95	0	419	17	5	441	107	567	0	0	674	
03:15 PM	0	0	95	0	95	0	420	14	1	435	120	668	0	0	788	
03:30 PM	0	0	89	1	90	0	349	14	3	366	126	676	0	0	802	
03:45 PM	0	0	84	1	85	0	447	14	2	463	135	671	0	0	806	
Total	0	0	358	7	365	0	1635	59	11	1705	488	2582	0	0	3070	
04:00 PM	0	0	67	0	67	0	340	11	1	352	126	762	0	0	888	
04:15 PM	0	0	68	2	70	0	401	16	2	419	149	673	0	0	822	
04:30 PM	0	0	90	0	90	0	416	11	4	431	131	771	0	0	902	
04:45 PM	0	0	66	0	66	0	353	7	0	360	138	687	0	0	825	
Total	0	0	291	2	293	0	1510	45	7	1562	544	2893	0	0	3437	
05:00 PM	0	0	82	5	87	0	362	12	7	381	134	726	0	0	860	
05:15 PM	0	0	77	1	78	0	450	14	6	470	152	763	0	0	915	
05:30 PM	0	0	72	1	73	0	369	8	3	380	127	739	0	0	866	
05:45 PM	0	0	71	0	71	0	360	17	1	378	144	813	0	0	957	
Total	0	0	302	7	309	0	1541	51	17	1609	557	3041	0	0	3598	
Grand Total	0	0	951	16	967	0	4686	155	35	4876	1589	8516	0	0	10105	
Approach %	0	0	98.3	1.7	99.9	0	96.1	3.2	0.7	99.2	15.7	84.3	0	0	86.4	
Total %	0	0	6	0.1	6.1	0	29.4	1	0.2	30.6	10	53.4	0	0	63.4	

Start Time	West Hind Drive Southbound					Kalaniana'ole Highway Westbound					Kalaniana'ole Highway Eastbound					Int. Total
	Left	Thru	Right	Peds	App. Total	Left	Thru	Right	Peds	App. Total	Left	Thru	Right	Peds	App. Total	
						Northbound										
05:00 PM	0	0	82	0	82	0	362	12	0	374	134	726	0	0	860	
05:15 PM	0	0	77	0	77	0	450	14	0	464	152	763	0	0	915	
05:30 PM	0	0	72	0	72	0	369	8	0	377	127	739	0	0	866	
05:45 PM	0	0	71	0	71	0	360	17	0	377	144	813	0	0	957	
Total Volume	0	0	302	0	302	0	1541	51	0	1592	557	3041	0	0	3598	
% App. Total	0	0	96.8	0	96.8	0	96.8	3.2	0	96.8	15.5	84.5	0	0	86.4	
PHF	.000	.000	.921	.000	.921	.000	.856	.750	.000	.858	.916	.935	.000	.000	.940	

Peak Hour Analysis From 03:00 PM to 05:45 PM - Peak 1 of 1
Peak Hour for Entire Intersection Begins at 05:00 PM

Wilson Okamoto Corporation

1907 S. Beretania Street, Suite 400
Honolulu, HI 96826

Counted By: CP, WM
Counters: D4-5677, D4-3889
Weather: Clear

File Name : KaiNen AM
Site Code : 00000007
Start Date : 9/9/2014
Page No : 1

Start Time	Groups Printed- Unshifted												Int. Total						
	Nenue Street Southbound				Kalaniana'ole Highway Westbound				Grace Chapel Honolulu Northbound					Kalaniana'ole Highway Eastbound					
	Left	Thru	Right	Peds	Left	Thru	Right	Peds	Left	Thru	Right	Peds		Left	Thru	Right	Peds	App. Total	
06:00 AM	8	0	5	0	0	715	30	0	0	0	0	0	0	104	0	0	0	104	862
06:15 AM	8	0	10	2	0	955	26	0	0	981	0	0	0	179	0	0	0	179	1180
06:30 AM	11	0	14	0	0	1134	35	0	0	1169	0	0	0	178	1	1	0	180	1374
06:45 AM	11	1	16	0	2	1149	31	0	0	1182	0	0	0	222	3	1	0	226	1438
Total	38	1	45	2	2	3953	122	0	0	4077	0	0	0	683	4	2	0	689	4854
07:00 AM	26	0	12	0	0	1106	42	0	0	1148	0	0	0	257	11	1	0	269	1456
07:15 AM	28	1	12	0	1	941	37	0	0	979	1	0	0	320	3	10	0	333	1355
07:30 AM	36	0	13	0	0	766	44	0	0	810	0	0	0	348	1	13	0	362	1221
07:45 AM	44	0	13	1	0	805	51	0	0	856	0	0	0	397	1	12	0	410	1324
Total	134	1	50	1	1	3618	174	0	0	3793	0	0	0	1322	16	36	0	1374	5356
08:00 AM	32	0	13	1	0	866	59	0	0	925	0	0	0	388	0	3	0	391	1362
08:15 AM	27	0	19	1	0	674	46	0	0	720	0	0	0	339	4	1	0	344	1111
08:30 AM	40	8	8	2	1	574	33	0	0	608	0	0	0	354	2	2	0	357	1024
08:45 AM	32	0	9	0	3	601	36	0	0	640	0	0	0	360	1	2	0	363	1044
Total	131	8	49	4	4	2715	174	0	0	2893	0	0	0	1441	7	7	0	1455	4541
Grand Total	303	10	144	7	7	1028	470	0	0	10763	0	0	0	3446	27	45	0	3518	14751
Approch %	65.3	2.2	31	1.5	0.1	95.6	4.4	0	0	83.3	16.7	0	0	98	0.8	1.3	0	23.8	
Total %	2.1	0.1	1	0	0	69.7	3.2	0	0	73	0	0	0	23.4	0.2	0.3	0	23.8	

Start Time	Groups Printed- Unshifted												Int. Total						
	Nenue Street Southbound				Kalaniana'ole Highway Westbound				Grace Chapel Honolulu Northbound					Kalaniana'ole Highway Eastbound					
	Left	Thru	Right	Peds	Left	Thru	Right	Peds	Left	Thru	Right	Peds		Left	Thru	Right	Peds	App. Total	
06:30 AM	11	0	14	0	0	1134	35	0	0	1169	0	0	0	178	1	1	0	180	1374
06:45 AM	11	1	16	0	2	1149	31	0	0	1182	0	0	0	222	3	1	0	226	1438
07:00 AM	26	0	12	0	0	1106	42	0	0	1148	0	0	0	257	11	1	0	269	1456
07:15 AM	28	1	12	0	1	941	37	0	0	979	1	0	0	320	3	10	0	333	1355
07:30 AM	36	0	13	0	0	766	44	0	0	810	0	0	0	348	1	13	0	362	1221
07:45 AM	44	0	13	1	0	805	51	0	0	856	0	0	0	397	1	12	0	410	1324
Total	76	2	54	0	3	4330	145	0	0	4478	0	0	0	977	18	13	0	1008	1355
% App. Total	57.6	1.5	40.9	0	0.1	96.7	3.2	0	0	96.9	16.7	0	0	96.9	1.8	1.3	0	96.9	5623
PHF	.679	.500	.844	.000	.375	.942	.863	.000	.947	.947	.250	.000	.000	.763	.409	.325	.000	.757	.965

Peak Hour Analysis From 06:00 AM to 08:45 AM - Peak 1 of 1
Peak Hour for Entire Intersection Begins at 06:30 AM

Wilson Okamoto Corporation

1907 S. Beretania Street, Suite 400
Honolulu, HI 96826

Counted By: CP, WM
Counters: D4-5677, D4-3889
Weather: Clear

File Name : KalNen AM - U-Turns
Site Code : 00000007
Start Date : 9/9/2014
Page No : 1

Groups Printed- Unshifted												
Kalaniana'ole Highway												
Start Time	Southbound		Westbound		Northbound		Left = U-Turns Eastbound		Thru	Peds	App. Total	Int. Total
	App. Total	App. Total	App. Total	App. Total	Right	Left						
06:00 AM	0	0	0	0	0	0	0	0	0	0	0	0
06:15 AM	0	0	0	0	0	0	0	0	0	0	0	0
06:30 AM	0	0	0	0	0	0	0	0	0	0	0	0
06:45 AM	0	0	0	0	0	0	0	0	0	0	0	0
Total	0	0	0	0	0	0	0	0	0	0	0	0
07:00 AM	0	0	0	0	0	0	0	0	0	0	0	0
07:15 AM	0	0	0	0	0	0	0	0	0	0	0	0
07:30 AM	0	0	0	0	0	0	0	0	0	0	0	0
07:45 AM	0	0	0	0	0	0	0	0	0	0	0	0
Total	0	0	0	0	0	0	0	0	0	0	0	0
08:00 AM	0	0	0	0	0	0	0	0	0	0	0	0
08:15 AM	0	0	0	0	0	0	0	0	0	0	0	0
08:30 AM	0	0	0	0	0	0	0	0	0	0	0	0
08:45 AM	0	0	0	0	0	0	0	0	0	0	0	0
Total	0	0	0	0	0	0	0	0	0	0	0	0
Grand Total	0	0	0	0	0	0	0	0	0	0	0	0
Approch %	100	100	100	100	0	0	0	0	0	0	0	0
Total %	0	0	0	0	0	0	0	0	0	0	100	4

Kalaniana'ole Highway												
Start Time	Southbound		Westbound		Northbound		Left = U-Turns Eastbound		Thru	Peds	App. Total	Int. Total
	App. Total	App. Total	App. Total	App. Total	Right	Left						
08:00 AM	0	0	0	0	0	0	0	0	0	0	0	0
08:15 AM	0	0	0	0	0	0	0	0	0	0	0	0
08:30 AM	0	0	0	0	0	0	0	0	0	0	0	0
08:45 AM	0	0	0	0	0	0	0	0	0	0	0	0
Total Volume	0	0	0	0	0	0	0	0	0	0	0	0
% App. Total	100	100	100	100	0	0	0	0	0	0	0	0
PHF	.000	.000	.000	.000	.000	.250	.000	.000	.000	.000	.250	.250

Wilson Okamoto Corporation

1907 S. Beretania Street, Suite 400
Honolulu, HI 96826

Counted By: CP, WM
Counter: D4-5677, D4-3889
Weather: Clear

File Name : KaiNen PM
Site Code : 00000007
Start Date : 9/9/2014
Page No : 1

Groups Printed- Unshifted

Start Time	Nenue Street Southbound				Kalaniana'ole Highway Westbound				Kalaniana'ole Highway Eastbound				Northbound			
	Left	Thru	Right	Peds	App. Total	Left	Thru	Right	Peds	App. Total	Left	Thru	Right	Peds	App. Total	Int. Total
03:00 PM	57	0	13	0	70	1	429	36	0	466	2	588	0	9	599	1135
03:15 PM	69	0	3	1	73	1	425	36	0	462	5	628	1	5	639	1174
03:30 PM	58	0	12	2	72	1	337	20	0	358	7	668	0	19	694	1124
03:45 PM	59	0	9	6	74	0	451	37	0	488	3	655	0	0	658	1220
Total	243	0	37	9	289	3	1642	129	0	1774	17	2539	1	33	2590	4653
04:00 PM	59	0	8	1	68	0	358	33	0	391	7	773	0	1	781	1240
04:15 PM	64	0	9	0	73	0	422	29	0	451	6	668	0	0	674	1198
04:30 PM	74	0	4	5	83	0	392	30	0	422	1	777	0	1	779	1284
04:45 PM	55	0	7	2	64	0	355	17	0	372	2	694	0	0	696	1132
Total	252	0	28	8	288	0	1527	109	0	1636	16	2912	0	2	2930	4854
05:00 PM	56	1	5	0	62	1	378	18	0	397	0	734	1	1	736	1195
05:15 PM	53	0	4	1	58	1	447	29	0	477	3	770	1	1	775	1310
05:30 PM	44	0	10	1	55	3	361	25	0	389	3	742	0	0	745	1189
05:45 PM	57	0	12	1	70	2	364	25	0	391	5	806	0	3	814	1275
Total	210	1	31	3	245	7	1550	97	0	1654	11	3052	2	5	3070	4969
Grand Total	705	1	96	20	822	10	4719	335	0	5064	44	8503	3	40	8590	14476
Approach %	85.8	0.1	11.7	2.4	5.7	0.2	93.2	6.6	0	35	0.5	99	0	0.5	59.3	
Total %	4.9	0	0.7	0.1		0.1	32.6	2.3	0		0.3	58.7	0	0.3		

Start Time	Nenue Street Southbound				Kalaniana'ole Highway Westbound				Kalaniana'ole Highway Eastbound				Northbound			
	Left	Thru	Right	Peds	App. Total	Left	Thru	Right	Peds	App. Total	Left	Thru	Right	Peds	App. Total	Int. Total
05:00 PM	56	1	5	5	62	1	378	18	0	397	0	734	1	1	735	1194
05:15 PM	53	0	4	4	57	1	447	29	0	477	3	770	1	1	774	1308
05:30 PM	44	0	10	10	54	3	361	25	0	389	3	742	0	0	745	1188
05:45 PM	57	0	12	12	69	2	364	25	0	391	5	806	0	0	811	1271
Total Volume	210	1	31	31	242	7	1550	97	0	1654	11	3052	2	2	3065	4961
% App. Total	86.8	0.4	12.8	6.46	.877	0.4	93.7	5.9	0	.867	0.4	99.6	0.1	0.1	.945	
PHF	.921	.250	.646		.877	.583	.867	.836	.836	.867	.550	.947	.500	.500	.945	

Peak Hour Analysis From 03:00 PM to 05:45 PM - Peak 1 of 1
Peak Hour for Entire Intersection Begins at 05:00 PM

Wilson Okamoto Corporation

1907 S. Beretania Street, Suite 400
Honolulu, HI 96826

Counted By: CP, WM
Counter: D4-5677, D4-3889
Weather: Clear

File Name : KalNen PM - U-Turns
Site Code : 00000007
Start Date : 9/9/2014
Page No : 1

Groups Printed- Unshifted

Start Time	Southbound		Westbound		Northbound		Kalaniana'ole Highway Eastbound				Int. Total
	App. Total	App. Total	App. Total	App. Total	App. Total	Left	Thru	Right	Peds	App. Total	
03:00 PM	0	0	0	0	0	4	0	0	0	4	4
03:15 PM	0	0	0	0	0	8	0	0	0	8	8
03:30 PM	0	0	0	0	0	13	0	0	0	13	13
03:45 PM	0	0	0	0	0	6	0	0	0	6	6
Total	0	0	0	0	0	31	0	0	0	31	31
04:00 PM	0	0	0	0	0	9	0	0	0	9	9
04:15 PM	0	0	0	0	0	4	0	0	0	4	4
04:30 PM	0	0	0	0	0	4	0	0	0	4	4
04:45 PM	0	0	0	0	0	4	0	0	0	4	4
Total	0	0	0	0	0	21	0	0	0	21	21
05:00 PM	0	0	0	0	0	2	0	0	0	2	2
05:15 PM	0	0	0	0	0	2	0	0	0	2	2
05:30 PM	0	0	0	0	0	1	0	0	0	1	1
05:45 PM	0	0	0	0	0	2	0	0	0	2	2
Total	0	0	0	0	0	7	0	0	0	7	7
Grand Total	0	0	0	0	0	59	0	0	0	59	59
Approch %						100	0	0	0	0	0
Total %						100	0	0	0	0	100

Start Time	Southbound		Westbound		Northbound		Kalaniana'ole Highway Eastbound				Int. Total
	App. Total	App. Total	App. Total	App. Total	App. Total	Left	Thru	Right	App. Total		
03:15 PM	0	0	0	0	0	8	0	0	0	8	8
03:30 PM	0	0	0	0	0	13	0	0	0	13	13
03:45 PM	0	0	0	0	0	6	0	0	0	6	6
04:00 PM	0	0	0	0	0	9	0	0	0	9	9
Total Volume	0	0	0	0	0	36	0	0	0	36	36
% App. Total						100	0	0	0	0	0
PHF						.692	.000	.000	.000	.692	.692

Peak Hour Analysis From 03:00 PM to 05:45 PM - Peak 1 of 1
Peak Hour for Entire Intersection Begins at 03:15 PM

Wilson Okamoto Corporation

1907 S. Beretania Street, Suite 400
Honolulu, HI 96826

Counted By: KC
Counter: D4-5674
Weather: Clear

File Name : NenNen AM
Site Code : 00000008
Start Date : 9/9/2014
Page No : 1

Groups Printed- Unshifted

Start Time	Nenue Street Southbound				Westbound				Nenue Street Northbound				Nenue Place Eastbound								
	Left	Thru	Right	Peds	App. Total	Left	Thru	Right	Peds	App. Total	Left	Thru	Right	Peds	App. Total	Left	Thru	Right	Peds	App. Total	Int. Total
06:00 AM	0	2	0	4	6	31	0	0	1	32	1	0	11	0	12	1	0	11	0	12	50
06:15 AM	0	4	3	1	8	27	0	0	2	29	3	0	14	1	18	3	0	14	1	18	55
06:30 AM	0	6	1	0	7	33	1	0	0	34	3	0	19	1	23	3	0	19	1	23	64
06:45 AM	0	7	0	0	7	28	3	0	0	31	2	0	20	0	22	2	0	20	0	22	60
Total	0	19	4	5	28	119	4	0	3	126	9	0	64	2	75	9	0	64	2	75	229
07:00 AM	0	8	0	2	10	33	9	0	0	42	1	0	30	0	31	1	0	30	0	31	83
07:15 AM	0	14	1	0	15	30	7	0	2	39	3	0	27	0	30	3	0	27	0	30	84
07:30 AM	0	19	4	2	27	36	10	0	8	54	5	0	29	6	40	5	0	29	6	40	121
07:45 AM	0	14	0	2	16	46	6	0	5	57	4	0	43	4	51	4	0	43	4	51	124
Total	0	55	5	8	68	145	32	0	15	192	13	0	129	10	152	13	0	129	10	152	412
08:00 AM	0	17	2	0	19	56	4	0	1	61	5	0	28	1	34	5	0	28	1	34	114
08:15 AM	0	11	2	0	13	43	2	0	1	46	1	0	35	2	38	1	0	35	2	38	97
08:30 AM	0	10	0	0	10	29	3	0	0	32	2	0	37	1	40	2	0	37	1	40	82
08:45 AM	0	7	0	2	9	32	6	0	0	38	1	0	34	6	41	1	0	34	6	41	88
Total	0	45	4	2	51	160	15	0	2	177	9	0	134	10	153	9	0	134	10	153	381
Grand Total	0	119	13	15	147	424	51	0	20	495	31	0	327	22	380	31	0	327	22	380	1022
Approach %	0	81	8.8	10.2	14.4	85.7	10.3	0	4	48.4	8.2	0	86.1	5.8	37.2	8.2	0	86.1	5.8	37.2	
Total %	0	11.6	1.3	1.5	14.4	41.5	5	0	2	48.4	3	0	32	2.2	37.2	3	0	32	2.2	37.2	

Start Time	Nenue Street Southbound				Westbound				Nenue Street Northbound				Nenue Place Eastbound								
	Left	Thru	Right	Peds	App. Total	Left	Thru	Right	Peds	App. Total	Left	Thru	Right	Peds	App. Total	Left	Thru	Right	Peds	App. Total	Int. Total
07:30 AM	0	19	4	4	23	36	10	0	0	46	5	0	29	34	103	5	0	29	34	103	
07:45 AM	0	14	0	0	14	46	6	0	0	52	4	0	43	47	113	4	0	43	47	113	
08:00 AM	0	17	2	2	19	56	4	0	0	60	5	0	28	33	112	5	0	28	33	112	
08:15 AM	0	11	0	0	11	43	2	0	0	45	1	0	35	36	94	1	0	35	36	94	
Total Volume	0	61	8	8	69	181	22	0	0	203	15	0	135	150	422	15	0	135	150	422	
% App. Total	0	88.4	11.6		750	89.2	10.8	0	0	846	10	0	90	798	934	10	0	90	798	934	
PHF	.000	.803	.500		.750	.808	.550	.000		.846	.750	.000	.785	.798	.934	.750	.000	.785	.798	.934	

Peak Hour Analysis From 06:00 AM to 08:45 AM - Peak 1 of 1

Peak Hour for Entire Intersection Begins at 07:30 AM

Wilson Okamoto Corporation

1907 S. Beretania Street, Suite 400
Honolulu, HI 96826

Counted By: KC
Counter: D4-5674
Weather: Clear

File Name : NenNen PM
Site Code : 00000008
Start Date : 9/9/2014
Page No : 1

Groups Printed- Unshifted

Start Time	Nenue Street Southbound				Westbound		Nenue Street Northbound				Nenue Place Eastbound					
	Left	Thru	Right	Peds	App. Total	Left	Thru	Right	Peds	App. Total	Left	Thru	Right	Peds	App. Total	Int. Total
03:00 PM	0	14	5	2	21	33	5	0	1	39	1	0	56	1	58	118
03:15 PM	0	6	4	4	14	37	5	0	0	42	2	0	66	0	68	124
03:30 PM	0	11	3	3	17	23	4	0	0	27	3	0	59	4	66	110
03:45 PM	0	7	4	1	12	37	4	0	0	41	4	0	58	1	63	116
Total	0	38	16	10	64	130	18	0	1	149	10	0	239	6	255	468
04:00 PM	0	11	2	2	15	41	6	0	0	47	4	0	56	0	60	122
04:15 PM	0	15	1	0	16	30	6	0	3	39	1	0	58	0	59	114
04:30 PM	0	13	2	0	15	31	2	0	0	33	1	0	65	0	66	114
04:45 PM	0	5	1	0	6	16	5	0	2	23	1	0	57	0	58	87
Total	0	44	6	2	52	118	19	0	5	142	7	0	236	0	243	437
05:00 PM	0	7	0	0	7	20	0	0	2	22	2	0	55	1	58	87
05:15 PM	0	10	3	1	14	27	6	0	1	34	2	0	47	1	50	98
05:30 PM	0	8	3	1	12	23	5	0	0	28	1	0	46	1	48	88
05:45 PM	0	15	1	2	18	24	6	0	2	32	4	0	54	0	58	108
Total	0	40	7	4	51	94	17	0	5	116	9	0	202	3	214	381
Grand Total	0	122	29	16	167	342	54	0	11	407	26	0	677	9	712	1286
Approach %	0	73.1	17.4	9.6	13	84	13.3	0	2.7	31.6	3.7	0	95.1	1.3	55.4	
Total %	0	9.5	2.3	1.2	13	26.6	4.2	0	0.9	31.6	2	0	52.6	0.7	55.4	

Start Time	Nenue Street Southbound				Westbound		Nenue Street Northbound				Nenue Place Eastbound					
	Left	Thru	Right	Peds	App. Total	Left	Thru	Right	Peds	App. Total	Left	Thru	Right	Peds	App. Total	Int. Total
03:45 PM	0	7	4	4	11	37	4	0	0	41	4	0	58	0	62	114
04:00 PM	0	11	2	2	13	41	6	0	0	47	4	0	56	0	60	120
04:15 PM	0	15	1	1	16	30	6	0	0	36	1	0	58	0	59	111
04:30 PM	0	13	2	2	15	31	2	0	0	33	1	0	65	0	66	114
Total Volume	0	46	9	9	55	139	18	0	0	157	10	0	237	0	247	459
% App. Total	0	83.6	16.4	16.4	13	88.5	11.5	0	0	31.6	4	0	96	0	936	
PHF	.000	.767	.563	.563	.859	.848	.750	.000	.000	.835	.625	.000	.912	.000	.936	.956

Peak Hour Analysis From 03:00 PM to 05:45 PM - Peak 1 of 1

Peak Hour for Entire Intersection Begins at 03:45 PM

Wilson Okamoto Corporation
 1907 S. Beretania Street, Suite 400
 Honolulu, HI 96826

Counted By: PA
 Counters: D4-3890
 Weather: Clear

File Name : WHindSite AM
 Site Code : 00000006
 Start Date : 9/9/2014
 Page No : 1

Groups Printed- Unshifted

Start Time	West Hind Drive Southbound					Westbound					Northbound					Longs Project Site Eastbound						
	Left	Thru	Right	Peds	App. Total	Left	Thru	Right	Peds	App. Total	Left	Thru	Right	Peds	App. Total	Left	Thru	Right	Peds	App. Total	Int. Total	
06:00 AM	0	0	0	0	0	0	0	0	0	0	0	0	0	0	0	0	0	0	1	1	1	1
06:15 AM	0	0	0	0	0	0	0	0	0	0	0	0	0	0	0	0	0	0	1	1	1	1
06:30 AM	0	0	0	0	0	0	0	0	0	0	0	0	0	0	0	0	0	0	2	2	2	2
06:45 AM	0	0	1	0	1	0	0	0	0	0	0	0	0	0	0	0	0	0	1	1	1	2
Total	0	0	1	0	1	0	0	0	0	0	0	0	0	0	0	0	0	0	5	5	5	6
07:00 AM	0	0	0	0	0	0	0	0	0	0	0	0	0	0	0	0	0	0	1	1	1	1
07:15 AM	0	0	0	0	0	0	0	0	0	0	0	0	0	0	0	0	0	0	0	0	0	0
07:30 AM	0	0	0	0	0	0	0	0	0	0	0	0	0	0	0	0	0	0	2	2	2	2
07:45 AM	0	0	5	0	5	0	0	0	0	0	0	0	0	0	0	0	0	0	1	1	1	6
Total	0	0	5	0	5	0	0	0	0	0	0	0	0	0	0	0	0	0	4	4	4	9
08:00 AM	0	0	1	0	1	0	0	0	0	0	0	0	0	0	0	0	0	0	2	2	2	3
08:15 AM	0	0	0	0	0	0	0	0	0	0	0	0	0	0	0	0	0	0	5	5	5	5
08:30 AM	0	0	0	0	0	0	0	0	0	0	0	0	0	0	0	0	0	0	0	0	0	0
08:45 AM	0	0	0	0	0	0	0	0	0	0	0	0	0	0	0	0	0	0	1	1	1	1
Total	0	0	1	0	1	0	0	0	0	0	0	0	0	0	0	0	0	0	8	8	8	9
Grand Total	0	0	7	0	7	0	0	0	0	0	0	0	0	0	0	0	0	0	17	17	17	24
Approch %	0	0	100	0	0	0	0	0	0	0	0	0	0	0	0	0	0	0	100	100	100	70.8
Total %	0	0	29.2	0	29.2	0	0	0	0	0	0	0	0	0	0	0	0	0	70.8	70.8	70.8	70.8

Start Time	West Hind Drive Southbound					Westbound					Northbound					Longs Project Site Eastbound						
	Left	Thru	Right	Peds	App. Total	Left	Thru	Right	Peds	App. Total	Left	Thru	Right	Peds	App. Total	Left	Thru	Right	Peds	App. Total	Int. Total	
07:30 AM	0	0	0	0	0	0	0	0	0	0	0	0	0	0	0	0	0	0	2	2	2	2
07:45 AM	0	0	5	0	5	0	0	0	0	0	0	0	0	0	0	0	0	0	1	1	1	6
08:00 AM	0	0	1	0	1	0	0	0	0	0	0	0	0	0	0	0	0	0	2	2	2	3
08:15 AM	0	0	0	0	0	0	0	0	0	0	0	0	0	0	0	0	0	0	5	5	5	5
Total Volume	0	0	6	0	6	0	0	0	0	0	0	0	0	0	0	0	0	0	10	10	10	16
% App. Total	0	0	100	0	0	0	0	0	0	0	0	0	0	0	0	0	0	0	100	100	100	70.8
PHF	.000	.000	.300	.000	.300	.000	.000	.000	.000	.000	.000	.000	.000	.000	.000	.000	.000	.000	.500	.500	.500	.667

Peak Hour Analysis From 06:00 AM to 08:45 AM - Peak 1 of 1
 Peak Hour for Entire Intersection Begins at 07:30 AM

Wilson Okamoto Corporation

1907 S. Beretania Street, Suite 400
Honolulu, HI 96826

Counted By: PA
Counter: D4-3890
Weather: Clear

File Name : WHindSite PM
Site Code : 00000006
Start Date : 9/9/2014
Page No : 1

Start Time	West Hind Drive Southbound						Groups Printed- Unshifted						Longs Project Site Eastbound																
	Left		Thru		Right		Peds		App. Total		Northbound		Westbound		App. Total		Left		Thru		Right		Peds		App. Total		Int. Total		
03:00 PM	0	0	0	0	2	0	0	0	2	0	0	0	0	0	0	0	0	0	0	0	0	0	3	0	3	0	0	5	
03:15 PM	0	0	0	0	2	0	0	0	2	0	0	0	0	0	0	0	0	0	0	0	0	0	0	0	0	0	0	2	
03:30 PM	0	0	0	0	0	0	0	0	0	0	0	0	0	0	0	0	0	0	0	0	0	0	0	0	0	0	0	0	
03:45 PM	0	0	0	0	0	0	0	0	0	0	0	0	0	0	0	0	0	0	0	0	0	0	0	0	0	0	0	0	
Total	0	0	0	0	4	0	0	0	4	0	0	0	0	0	0	0	0	0	0	0	0	1	3	0	4	0	0	8	
04:00 PM	0	0	0	0	0	0	0	0	0	0	0	0	0	0	0	0	0	0	0	0	0	0	0	0	0	0	0	0	
04:15 PM	0	0	0	0	0	0	0	0	0	0	0	0	0	0	0	0	0	0	0	0	0	2	1	3	0	0	0	3	
04:30 PM	0	0	0	0	0	0	0	0	0	0	0	0	0	0	0	0	0	0	0	0	0	4	4	4	0	0	0	4	
04:45 PM	0	0	0	0	0	0	0	0	0	0	0	0	0	0	0	0	0	0	0	0	0	0	1	1	0	0	0	1	
Total	0	0	0	0	0	0	0	0	0	0	0	0	0	0	0	0	0	0	0	0	0	2	6	8	0	0	0	8	
05:00 PM	0	0	0	0	0	0	0	0	0	0	0	0	0	0	0	0	0	0	0	0	0	0	0	0	0	0	0	0	
05:15 PM	0	0	0	0	0	0	0	0	0	0	0	0	0	0	0	0	0	0	0	0	0	3	3	3	0	0	0	3	
05:30 PM	0	0	0	0	0	0	0	0	0	0	0	0	0	0	0	0	0	0	0	0	0	1	1	1	0	0	0	1	
05:45 PM	0	0	0	0	0	0	0	0	0	0	0	0	0	0	0	0	0	0	0	0	0	0	0	0	0	0	0	0	
Total	0	0	0	0	0	0	0	0	0	0	0	0	0	0	0	0	0	0	0	0	0	0	5	5	5	0	0	0	5
Grand Total	0	0	0	0	4	0	0	0	4	0	0	0	0	0	0	0	0	0	0	0	0	3	14	17	0	0	0	21	
Approch %	0	0	0	0	100	0	0	0	0	0	0	0	0	0	0	0	0	0	0	0	0	17.6	82.4	81	0	0	0	81	
Total %	0	0	0	0	19	0	0	0	19	0	0	0	0	0	0	0	0	0	0	0	0	14.3	66.7	81	0	0	0	81	

Start Time	West Hind Drive Southbound						Westbound						Northbound						Longs Project Site Eastbound									
	Left		Thru		Right		Peds		App. Total		Westbound		Northbound		App. Total		Left		Thru		Right		Peds		App. Total		Int. Total	
03:00 PM	0	0	0	0	0	2	0	0	2	0	0	0	0	0	0	0	0	0	0	0	0	0	0	0	0	0	0	2
03:15 PM	0	0	0	0	0	2	0	0	2	0	0	0	0	0	0	0	0	0	0	0	0	0	0	0	0	0	0	2
03:30 PM	0	0	0	0	0	0	0	0	0	0	0	0	0	0	0	0	0	0	0	0	0	0	0	0	0	0	0	0
03:45 PM	0	0	0	0	0	0	0	0	0	0	0	0	0	0	0	0	0	0	0	0	0	0	0	0	0	0	0	0
Total Volume	0	0	0	0	4	0	0	0	4	0	0	0	0	0	0	0	0	0	0	0	0	1	1	1	0	0	0	5
% App. Total	0	0	0	0	100	0	0	0	100	0	0	0	0	0	0	0	0	0	0	0	0	100	100	100	0	0	0	100
PHF	.000	.000	.000	.000	.500	.000	.000	.000	.500	.000	.000	.000	.000	.000	.000	.000	.000	.000	.000	.000	.250	.250	.250	.000	.250	.000	.625	

Peak Hour Analysis From 03:00 PM to 05:45 PM - Peak 1 of 1
Peak Hour for Entire Intersection Begins at 03:00 PM

Wilson Okamoto Corporation

1907 S. Beretania Street, Suite 400
Honolulu, HI 96826

Counted By: BC
Counter: TU-0650, TU-0651
Weather: Clear

File Name : WHindSouthEnt AM
Site Code : 00000003
Start Date : 9/9/2014
Page No : 1

Groups Printed- Unshifted

Start Time	West Hind Drive Southbound				Nenu Place Westbound				West Hind Drive Northbound				Eastbound			
	Left	Thru	Right	Peds	App. Total	Left	Thru	Right	Peds	App. Total	Left	Thru	Right	Peds	App. Total	Int. Total
06:00 AM	0	58	0	0	58	17	0	2	1	20	0	14	7	0	21	0
06:15 AM	2	74	0	0	76	15	0	4	0	19	0	31	19	0	50	0
06:30 AM	2	108	0	0	110	8	0	6	0	14	0	28	37	0	65	0
06:45 AM	2	110	0	0	112	7	0	4	0	11	0	28	17	0	45	0
Total	6	350	0	0	356	47	0	16	1	64	0	101	80	0	181	0
07:00 AM	1	73	0	0	74	16	0	2	4	22	0	42	27	0	69	0
07:15 AM	1	76	0	0	77	9	0	6	2	17	0	68	26	0	94	0
07:30 AM	5	86	0	0	91	7	0	7	0	14	0	116	36	0	152	0
07:45 AM	3	95	0	0	98	12	0	8	0	20	0	123	38	0	161	0
Total	10	330	0	0	340	44	0	23	6	73	0	349	127	0	476	0
08:00 AM	1	100	0	0	101	17	1	4	2	24	0	91	51	0	142	0
08:15 AM	3	55	0	0	58	23	0	14	3	40	0	59	46	0	105	0
08:30 AM	1	59	0	0	60	20	0	8	1	29	0	43	57	0	100	0
08:45 AM	8	73	0	0	81	18	0	11	1	30	0	57	29	0	86	0
Total	13	287	0	0	300	78	1	37	7	123	0	250	183	0	433	0
Grand Total	29	967	0	0	996	169	1	76	14	260	0	700	390	0	1090	0
Approch %	2.9	97.1	0	0	42.5	65	0.4	29.2	5.4	11.1	0	64.2	35.8	0	46.5	0
Total %	1.2	41.2	0	0		7.2	0	3.2	0.6		0	29.8	16.6	0		

Start Time	West Hind Drive Southbound				Nenu Place Westbound				West Hind Drive Northbound				Eastbound			
	Left	Thru	Right	Peds	App. Total	Left	Thru	Right	Peds	App. Total	Left	Thru	Right	Peds	App. Total	Int. Total
07:30 AM	5	86	0	0	91	7	0	0	7	14	0	116	36	0	152	0
07:45 AM	3	95	0	0	98	12	0	8	8	20	0	123	38	0	161	0
08:00 AM	1	100	0	0	101	17	1	4	4	22	0	91	51	0	142	0
08:15 AM	3	55	0	0	58	23	0	14	3	40	0	59	46	0	105	0
Total Volume	12	336	0	0	348	59	1	33	14	93	0	389	171	0	560	0
% App. Total	3.4	96.6	0	0	86.1	63.4	1.1	35.5	5.89	23.2	0	69.5	30.5	0	46.5	0
PHF	.600	.840	.000	.000	.861	.641	.250	.589	.628	.628	.000	.791	.838	.870	.000	.897

Peak Hour Analysis From 06:00 AM to 08:45 AM - Peak 1 of 1
Peak Hour for Entire Intersection Begins at 07:30 AM

Wilson Okamoto Corporation

1907 S. Beretania Street, Suite 400
Honolulu, HI 96826

Counted By: BC
Counter: TU-0650, TU-0651
Weather: Clear

File Name : WHindSouthEnt PM
Site Code : 00000003
Start Date : 9/9/2014
Page No : 1

Groups Printed- Unshifted

Start Time	West Hind Drive Southbound					Nenu Place Westbound					West Hind Drive Northbound					Eastbound	
	Left	Thru	Right	Peds	App. Total	Left	Thru	Right	Peds	App. Total	Left	Thru	Right	Peds	App. Total	App. Total	Int. Total
	03:00 PM	3	63	1	1	68	26	0	3	1	30	0	76	48	0	124	0
03:15 PM	4	64	1	1	70	20	0	14	2	36	0	80	52	0	132	0	238
03:30 PM	3	63	2	2	70	20	0	10	2	32	0	87	43	0	130	0	232
03:45 PM	6	57	1	1	65	26	0	10	3	39	0	89	50	0	139	0	243
Total	16	247	5	5	273	92	0	37	8	137	0	332	193	0	525	0	935
04:00 PM	1	46	1	1	49	22	1	8	1	32	0	87	51	0	138	0	219
04:15 PM	3	48	0	0	51	17	0	11	3	31	0	110	59	0	169	0	251
04:30 PM	6	62	2	2	72	25	0	5	1	31	0	98	46	3	147	0	250
04:45 PM	3	41	1	1	46	22	0	13	2	37	0	96	48	0	144	0	227
Total	13	197	4	4	218	86	1	37	7	131	0	391	204	3	598	0	947
05:00 PM	1	55	2	2	60	30	0	9	5	44	0	99	38	0	137	0	241
05:15 PM	6	57	5	5	73	17	0	6	3	24	0	108	49	0	157	0	254
05:30 PM	0	48	0	0	48	17	0	7	1	25	0	90	42	0	132	0	205
05:45 PM	2	60	1	1	64	21	0	7	2	30	0	97	60	0	157	0	251
Total	9	220	8	8	245	83	0	29	11	123	0	394	189	0	583	0	951
Grand Total	38	664	17	17	736	261	1	103	26	391	0	1117	586	3	1706	0	2833
Approch %	5.2	90.2	2.3	2.3	66.8	0.3	0.3	26.3	6.6	13.8	0	65.5	34.3	0.2	60.2	0	2833
Total %	1.3	23.4	0.6	0.6	26	9.2	0	3.6	0.9	13.8	0	39.4	20.7	0.1	60.2	0	2833

Start Time	West Hind Drive Southbound					Nenu Place Westbound					West Hind Drive Northbound					Eastbound	
	Left	Thru	Right	Peds	App. Total	Left	Thru	Right	Peds	App. Total	Left	Thru	Right	Peds	App. Total	App. Total	Int. Total
	04:30 PM	6	62	2	2	72	25	0	5	1	31	0	98	46	3	147	0
04:45 PM	3	41	1	1	46	22	0	13	2	37	0	96	48	0	144	0	227
05:00 PM	1	55	2	2	60	30	0	9	5	44	0	99	38	0	137	0	241
05:15 PM	6	57	5	5	73	15	0	6	3	24	0	108	49	0	157	0	254
Total Volume	16	215	10	10	251	92	0	33	11	136	0	401	181	3	585	0	972
% App. Total	6.4	85.7	4	4	67.6	0.0	0.0	24.3	8.1	13.6	0	68.5	30.9	0.5	60.2	0	972
PHF	.667	.867	.500	.500	.860	.767	.000	.635	.550	.773	.000	.928	.923	.250	.932	.000	.957

Peak Hour Analysis From 03:00 PM to 05:45 PM - Peak 1 of 1
Peak Hour for Entire Intersection Begins at 04:30 PM

Wilson Okamoto Corporation

1907 S. Beretania Street, Suite 400
Honolulu, HI 96826

Counted By: BC
Counter: TU-0650, TU-0651
Weather: Clear

File Name : WHindNorthEnt AM
Site Code : 00000003
Start Date : 9/9/2014
Page No : 1

Groups Printed - Unshifted

Start Time	West Hind Drive Southbound				West Hind Drive SC North Entrance Westbound				West Hind Drive Northbound				Aina Haina School Exit Eastbound				Int. Total				
	Left	Thru	Right	Peds	App. Total	Left	Thru	Right	Peds	App. Total	Left	Thru	Right	Peds	App. Total	Left		Thru	Right	Peds	App. Total
06:00 AM	6	57	0	3	66	9	2	1	0	12	0	13	1	0	14	0	0	0	4	4	96
06:15 AM	7	69	0	2	78	12	0	7	1	20	0	29	6	0	35	0	0	0	0	0	133
06:30 AM	10	94	1	2	107	22	0	9	1	32	1	24	3	0	28	0	0	0	2	2	169
06:45 AM	12	98	1	6	117	12	0	11	0	23	0	28	3	0	31	1	1	1	1	4	175
Total	35	318	2	13	368	55	2	28	2	87	1	94	13	0	108	1	1	1	7	10	573
07:00 AM	7	63	0	1	71	13	0	6	4	23	0	40	1	0	41	2	2	3	1	8	143
07:15 AM	13	59	1	2	75	16	0	11	3	30	0	63	3	0	66	5	4	13	1	23	194
07:30 AM	14	60	0	3	77	9	0	7	1	17	0	112	25	0	137	15	6	22	0	43	274
07:45 AM	19	62	0	4	85	13	0	12	1	26	0	128	1	0	129	17	13	30	1	61	301
Total	53	244	1	10	308	51	0	36	9	96	0	343	30	0	373	39	25	68	3	135	912
08:00 AM	14	67	1	6	88	13	0	10	2	25	1	85	13	0	99	6	6	26	0	38	250
08:15 AM	9	32	0	3	44	21	0	10	1	32	0	61	16	0	77	1	0	5	0	6	159
08:30 AM	10	48	0	2	60	10	0	6	0	16	7	38	8	0	53	0	1	2	0	3	132
08:45 AM	9	54	0	0	63	23	0	7	1	31	0	61	6	0	67	0	0	1	0	1	162
Total	42	201	1	11	255	67	0	33	4	104	8	245	43	0	296	7	7	34	0	48	703
Grand Total	130	763	4	34	931	173	2	97	15	287	9	682	86	0	777	47	33	103	10	193	2188
Approch %	14	82	0.4	3.7	42.6	60.3	0.7	33.8	5.2	13.1	1.2	87.8	11.1	0	35.5	24.4	17.1	53.4	5.2	8.8	
Total %	5.9	34.9	0.2	1.6	42.6	7.9	0.1	4.4	0.7	13.1	0.4	31.2	3.9	0	35.5	2.1	1.5	4.7	0.5	8.8	

Start Time	West Hind Drive Southbound				West Hind Drive SC North Entrance Westbound				West Hind Drive Northbound				Aina Haina School Exit Eastbound				Int. Total		
	Left	Thru	Right	Peds	App. Total	Left	Thru	Right	Peds	App. Total	Left	Thru	Right	Peds	App. Total	Left		Thru	Right
07:15 AM	13	59	1	73	16	0	11	3	66	5	4	13	22	188					
07:30 AM	14	60	0	74	9	0	7	25	137	15	6	22	43	270					
07:45 AM	19	62	0	81	13	0	12	1	129	17	13	30	60	295					
08:00 AM	14	67	1	82	13	0	10	13	99	6	6	26	38	242					
Total Volume	60	248	2	310	51	0	40	42	431	43	29	91	163	995					
% App. Total	19.4	80	0.6	.945	56	0	44	9.7	26.4	17.8	55.8	7.58	.679	.843					
PHF	.789	.925	.500	.945	.797	.000	.833	.420	.786	.632	.558	.758	.679	.843					

Peak Hour Analysis From 06:00 AM to 08:45 AM - Peak 1 of 1
Peak Hour for Entire Intersection Begins at 07:15 AM

Wilson Okamoto Corporation

1907 S. Beretania Street, Suite 400
Honolulu, HI 96826

Counted By: BC
Counter: BC
Weather: Clear

File Name : WHindNorthEnt PM
Site Code : 00000003
Start Date : 9/9/2014
Page No : 1

Groups Printed- Unshifted

Start Time	West Hind Drive Southbound					West Hind Drive SC North Entrance Westbound					West Hind Drive Northbound					Aina Haina School Exit Eastbound					
	Left	Thru	Right	Peds	App. Total	Left	Thru	Right	Peds	App. Total	Left	Thru	Right	Peds	App. Total	Left	Thru	Right	Peds	App. Total	Int. Total
03:00 PM	5	36	0	7	48	20	0	4	2	26	0	58	25	0	83	2	2	9	1	14	171
03:15 PM	9	34	0	3	46	25	0	7	2	34	0	66	30	0	96	1	1	8	0	10	186
03:30 PM	8	41	0	13	62	23	0	10	2	35	0	69	29	0	98	5	3	2	10	20	215
03:45 PM	7	32	0	7	46	19	1	9	4	33	0	72	32	0	104	3	0	10	2	15	198
Total	29	143	0	30	202	87	1	30	10	128	0	265	116	0	381	11	6	29	13	59	770
04:00 PM	7	24	0	1	32	17	0	17	1	35	0	71	24	0	95	3	4	5	1	13	175
04:15 PM	3	23	0	8	34	17	0	21	3	41	0	104	14	0	118	8	3	10	5	26	219
04:30 PM	4	31	0	1	36	18	0	12	1	31	2	88	15	1	106	15	8	14	0	37	210
04:45 PM	10	22	0	6	38	16	0	12	2	30	0	92	17	0	109	5	1	6	0	13	190
Total	24	100	0	16	140	68	0	62	7	137	2	355	70	1	428	31	16	35	7	89	794
05:00 PM	10	30	0	6	46	19	0	13	5	37	0	90	27	0	117	3	1	7	1	12	212
05:15 PM	9	32	0	3	44	18	0	15	3	36	0	91	25	0	116	4	2	10	1	17	213
05:30 PM	7	35	0	1	43	13	0	9	1	23	0	69	29	0	98	1	2	2	1	6	170
05:45 PM	8	41	0	6	55	17	0	16	2	35	1	64	43	2	110	2	2	4	2	10	210
Total	34	138	0	16	188	67	0	53	11	131	1	314	124	2	441	10	7	23	5	45	805
Grand Total	87	381	0	62	530	222	1	145	28	396	3	934	310	3	1250	52	29	87	25	193	2369
Approch %	16.4	71.9	0	11.7	56.1	0.3	0.3	36.6	7.1	16.7	0.2	74.7	24.8	0.2	26.9	15	15	45.1	13	8.1	
Total %	3.7	16.1	0	2.6	22.4	9.4	0	6.1	1.2	16.7	0.1	39.4	13.1	0.1	52.8	2.2	1.2	3.7	1.1	8.1	

Start Time	West Hind Drive Southbound					West Hind Drive SC North Entrance Westbound					West Hind Drive Northbound					Aina Haina School Exit Eastbound					
	Left	Thru	Right	Peds	App. Total	Left	Thru	Right	Peds	App. Total	Left	Thru	Right	Peds	App. Total	Left	Thru	Right	Peds	App. Total	Int. Total
04:30 PM	4	31	0	0	35	18	0	12	0	30	2	88	15	0	105	15	8	14	0	37	207
04:45 PM	10	22	0	0	32	16	0	12	0	28	0	92	17	0	109	5	1	6	0	12	181
05:00 PM	10	30	0	0	40	19	0	13	0	32	0	90	27	0	117	3	1	7	0	11	200
05:15 PM	9	32	0	0	41	18	0	15	0	33	0	91	25	0	116	4	2	10	0	16	206
Total Volume	33	115	0	0	148	71	0	52	0	123	2	361	84	0	447	27	12	37	0	76	794
% App. Total	22.3	77.7	0	0	57.7	0.4	0.4	80.8	18.8	35.5	0.4	80.8	18.8	0.1	35.5	15.8	15.8	48.7	0.1	76	794
PHF	.825	.898	.000	.000	.902	.934	.000	.867	.867	.932	.250	.981	.778	.000	.955	.450	.375	.661	.000	.514	.959

Peak Hour Analysis From 03:00 PM to 05:45 PM - Peak 1 of 1
Peak Hour for Entire Intersection Begins at 04:30 PM

Wilson Okamoto Corporation

1907 S. Beretania Street, Suite 400
Honolulu, HI 96826

Counted By:LS
Counter:D4-3888
Weather:Clear

File Name : WHindMak AM
Site Code : 00000002
Start Date : 9/9/2014
Page No : 1

Groups Printed- Unshifted

Start Time	Southbound				Makalena Street Westbound				West Hind Drive Northbound				Eastbound															
	App. Total	Left	Thru	Right	Peds	App. Total	Left	Thru	Right	Peds	App. Total	Left	Thru	Right	Peds	App. Total	Left	Thru	Right	Peds	App. Total	Left	Thru	Right	Peds	App. Total	Int. Total	
06:00 AM	0	4	0	0	0	4	3	10	1	0	14	3	10	1	0	14	3	10	1	0	14	3	10	1	0	14	0	18
06:15 AM	0	1	0	0	3	4	2	27	1	0	30	2	27	1	0	30	2	27	1	0	30	2	27	1	0	30	0	34
06:30 AM	0	0	0	1	1	2	3	28	2	0	33	3	28	2	0	33	3	28	2	0	33	3	28	2	0	33	0	35
06:45 AM	0	1	0	1	5	7	9	26	0	9	35	9	26	0	9	35	9	26	0	9	35	9	26	0	9	35	0	42
Total	0	6	0	2	9	17	17	91	4	17	112	17	91	4	17	112	17	91	4	17	112	17	91	4	17	112	0	129
07:00 AM	0	4	0	1	4	9	14	31	1	4	46	14	31	1	4	46	14	31	1	4	46	14	31	1	4	46	0	55
07:15 AM	0	0	0	0	8	8	33	48	4	8	85	33	48	4	8	85	33	48	4	8	85	33	48	4	8	85	0	93
07:30 AM	0	1	0	0	2	3	61	57	1	2	119	61	57	1	2	119	61	57	1	2	119	61	57	1	2	119	0	122
07:45 AM	0	1	1	0	3	5	81	76	5	3	162	81	76	5	3	162	81	76	5	3	162	81	76	5	3	162	0	167
Total	0	6	1	1	17	25	189	212	11	17	412	189	212	11	17	412	189	212	11	17	412	189	212	11	17	412	0	437
08:00 AM	0	2	0	1	1	4	21	70	1	1	93	21	70	1	1	93	21	70	1	1	93	21	70	1	1	93	0	97
08:15 AM	0	1	0	0	1	2	11	56	1	1	68	11	56	1	1	68	11	56	1	1	68	11	56	1	1	68	0	70
08:30 AM	0	3	0	0	2	5	11	33	2	2	46	11	33	2	2	46	11	33	2	2	46	11	33	2	2	46	0	51
08:45 AM	0	2	0	0	1	3	6	57	1	1	64	6	57	1	1	64	6	57	1	1	64	6	57	1	1	64	0	67
Total	0	8	0	1	5	14	49	216	5	5	271	49	216	5	5	271	49	216	5	5	271	49	216	5	5	271	0	285
Grand Total	0	20	1	4	31	56	255	519	20	31	795	255	519	20	31	795	255	519	20	31	795	255	519	20	31	795	0	851
Approch %		35.7	1.8	7.1	55.4		32.1	65.3	2.5	0.1		32.1	65.3	2.5	0.1		32.1	65.3	2.5	0.1		32.1	65.3	2.5	0.1			
Total %	0	2.4	0.1	0.5	3.6	6.6	30	61	2.4	0.1	93.4	30	61	2.4	0.1	93.4	30	61	2.4	0.1	93.4	30	61	2.4	0.1	93.4	0	

Start Time	Southbound				Makalena Street Westbound				West Hind Drive Northbound				Eastbound															
	App. Total	Left	Thru	Right	Peds	App. Total	Left	Thru	Right	Peds	App. Total	Left	Thru	Right	Peds	App. Total	Left	Thru	Right	Peds	App. Total	Left	Thru	Right	Peds	App. Total	Int. Total	
07:15 AM	0	0	0	0	0	0	33	48	4	0	85	33	48	4	0	85	33	48	4	0	85	33	48	4	0	85	0	
07:30 AM	0	1	1	0	0	1	61	57	1	0	119	61	57	1	0	119	61	57	1	0	119	61	57	1	0	119	0	
07:45 AM	0	1	1	0	0	2	81	76	5	0	162	81	76	5	0	162	81	76	5	0	162	81	76	5	0	162	0	
08:00 AM	0	2	2	1	1	3	21	70	1	1	92	21	70	1	1	92	21	70	1	1	92	21	70	1	1	92	0	
Total Volume	0	4	4	1	1	6	196	251	11	6	458	196	251	11	6	458	196	251	11	6	458	196	251	11	6	458	0	
% App. Total	.000	.500	.250	.167	.250	.500	.605	.826	.250	.550	.707	.605	.826	.250	.550	.707	.605	.826	.250	.550	.707	.605	.826	.250	.550	.707	.000	
PHF																												

Peak Hour Analysis From 06:00 AM to 08:45 AM - Peak 1 of 1
Peak Hour for Entire Intersection Begins at 07:15 AM

Wilson Okamoto Corporation

1907 S. Beretania Street, Suite 400
Honolulu, HI 96826

Counted By: FS
Counters: D4-3888
Weather: Clear

File Name : WHindMak AM-1
Site Code : 00000002
Start Date : 9/9/2014
Page No : 1

Groups Printed- Unshifted

Start Time	West Hind Drive Southbound					Westbound					Northbound					Entrance To School Eastbound											
	Left	Thru	Right	Peds	App. Total	Left	Thru	Right	Peds	App. Total	Left	Thru	Right	Peds	App. Total	Left	Thru	Right	Peds	App. Total	Left	Thru	Right	Peds	App. Total	Int. Total	
06:00 AM	1	60	0	1	62	0	0	0	0	0	0	0	0	0	0	0	0	0	1	1	0	0	0	0	0	63	
06:15 AM	3	84	0	0	87	0	0	0	0	0	0	0	0	0	0	0	0	0	0	0	0	0	0	0	0	87	
06:30 AM	0	103	1	0	104	0	0	0	0	0	0	0	0	0	0	0	0	0	0	0	0	0	0	0	0	104	
06:45 AM	0	104	2	0	106	0	0	0	0	0	0	0	0	0	0	0	0	0	0	0	0	0	0	0	0	106	
Total	4	351	3	1	359	0	0	0	0	0	0	0	0	0	0	0	0	0	1	1	0	0	0	0	0	360	
07:00 AM	0	63	1	1	65	0	0	0	0	0	0	0	0	0	0	0	0	0	0	0	0	0	0	0	0	65	
07:15 AM	0	64	7	1	72	0	0	0	0	0	0	0	0	0	0	0	0	0	6	6	0	0	0	0	0	78	
07:30 AM	0	63	14	2	79	0	0	0	0	0	0	0	0	0	0	0	0	0	10	10	0	0	0	0	0	89	
07:45 AM	0	63	23	5	91	0	0	0	0	0	0	0	0	0	0	0	0	0	27	27	0	0	0	0	0	118	
Total	0	253	45	9	307	0	0	0	0	0	0	0	0	0	0	0	0	0	43	43	0	0	0	0	0	350	
08:00 AM	0	54	2	1	57	0	0	0	0	0	0	0	0	0	0	0	0	0	4	4	0	0	0	0	0	61	
08:15 AM	0	49	2	0	51	0	0	0	0	0	0	0	0	0	0	0	0	0	1	1	0	0	0	0	0	52	
08:30 AM	0	52	2	1	55	0	0	0	0	0	0	0	0	0	0	0	0	0	0	0	0	0	0	0	0	55	
08:45 AM	0	62	1	0	63	0	0	0	0	0	0	0	0	0	0	0	0	0	2	2	0	0	0	0	0	65	
Total	0	217	7	2	226	0	0	0	0	0	0	0	0	0	0	0	0	0	7	7	0	0	0	0	0	0	233
Grand Total	4	821	55	12	892	0	0	0	0	0	0	0	0	0	0	0	0	0	51	51	0	0	0	0	0	0	943
Apprch %	0.4	92	6.2	1.3	94.6	0	0	0	0	0	0	0	0	0	0	0	0	0	100	100	0	0	0	0	0	0	5.4
Total %	0.4	87.1	5.8	1.3	94.6	0	0	0	0	0	0	0	0	0	0	0	0	0	5.4	5.4	0	0	0	0	0	0	5.4

Start Time	West Hind Drive Southbound					Westbound					Northbound					Entrance To School Eastbound											
	Left	Thru	Right	Peds	App. Total	Left	Thru	Right	Peds	App. Total	Left	Thru	Right	Peds	App. Total	Left	Thru	Right	Peds	App. Total	Left	Thru	Right	Peds	App. Total	Int. Total	
06:15 AM	3	84	0	0	87	0	0	0	0	0	0	0	0	0	0	0	0	0	0	0	0	0	0	0	0	87	
06:30 AM	0	103	1	0	104	0	0	0	0	0	0	0	0	0	0	0	0	0	0	0	0	0	0	0	0	104	
06:45 AM	0	104	2	0	106	0	0	0	0	0	0	0	0	0	0	0	0	0	0	0	0	0	0	0	0	106	
07:00 AM	0	63	1	0	64	0	0	0	0	0	0	0	0	0	0	0	0	0	0	0	0	0	0	0	0	64	
Total Volume	3	354	4	0	361	0	0	0	0	0	0	0	0	0	0	0	0	0	0	0	0	0	0	0	0	361	
% App. Total	0.8	98.1	1.1	0	99.6	0	0	0	0	0	0	0	0	0	0	0	0	0	0	0	0	0	0	0	0	0	99.6
PHF	.250	.851	.500	.000	.851	.000	.000	.000	.000	.000	.000	.000	.000	.000	.000	.000	.000	.000	.000	.000	.000	.000	.000	.000	.000	.851	

Peak Hour for Entire Intersection Begins at 06:15 AM

Wilson Okamoto Corporation

1907 S. Beretania Street, Suite 400
Honolulu, HI 96826

Counted By: IA
Counter: D4-3888
Weather: Clear

File Name : WHindMak PM
Site Code : 00000002
Start Date : 9/9/2014
Page No : 1

Groups Printed- Unshifted

Start Time	Southbound				Makalena Street Westbound				West Hind Drive Northbound				Eastbound						
	App. Total	Left	Thru	Right	App. Total	Peds	Right	Thru	Left	App. Total	Peds	Right	Thru	App. Total	Peds	Right	Thru	App. Total	Int. Total
03:00 PM	0	1	0	0	1	0	0	0	2	58	0	0	0	60	0	0	0	0	61
03:15 PM	0	0	0	1	1	0	0	0	8	68	1	0	0	77	0	0	0	0	78
03:30 PM	0	1	0	1	2	0	0	0	3	77	0	0	0	80	0	0	0	0	82
03:45 PM	0	1	0	0	1	0	0	0	12	68	2	0	0	82	0	0	0	0	83
Total	0	3	0	2	5	0	0	0	25	271	3	0	0	299	0	0	0	0	304
04:00 PM	0	0	0	1	1	0	0	0	13	70	0	0	0	90	0	0	0	0	91
04:15 PM	0	0	0	0	1	1	0	0	28	107	1	0	0	136	0	0	0	0	137
04:30 PM	0	2	0	1	9	6	0	0	16	98	1	0	0	115	0	0	0	0	124
04:45 PM	0	0	0	1	2	1	0	0	11	92	8	0	0	111	0	0	0	0	113
Total	0	2	0	3	13	8	0	0	68	367	17	0	0	452	0	0	0	0	465
05:00 PM	0	0	0	1	4	3	0	0	6	92	0	0	0	101	0	0	0	0	105
05:15 PM	0	3	0	2	7	2	0	0	9	83	6	0	0	98	0	0	0	0	105
05:30 PM	0	1	0	0	5	4	0	0	3	63	13	0	0	79	0	0	0	0	84
05:45 PM	0	1	0	0	3	2	0	0	5	85	2	0	0	92	0	0	0	0	95
Total	0	5	0	3	19	11	0	0	23	323	24	0	0	370	0	0	0	0	389
Grand Total	0	10	0	8	37	19	0	0	116	961	44	0	0	1121	0	0	0	0	1158
Approch %	0	27	0	21.6	51.4	51.4	0	0	10.3	85.7	3.9	0	0	96.8	0	0	0	0	
Total %	0	0.9	0	0.7	3.2	1.6	0	0	10	83	3.8	0	0		0	0	0	0	

Start Time	Southbound				Makalena Street Westbound				West Hind Drive Northbound				Eastbound						
	App. Total	Left	Thru	Right	App. Total	Peds	Right	Thru	Left	App. Total	Peds	Right	Thru	App. Total	Peds	Right	Thru	App. Total	Int. Total
04:15 PM	0	0	0	0	0	0	0	0	28	107	1	0	0	136	0	0	0	0	136
04:30 PM	0	2	0	1	3	1	0	0	16	98	1	0	0	115	0	0	0	0	118
04:45 PM	0	0	0	1	1	1	0	0	11	92	8	0	0	111	0	0	0	0	112
05:00 PM	0	0	0	1	1	1	0	0	6	92	3	0	0	101	0	0	0	0	102
Total Volume	0	2	0	3	5	3	0	0	61	389	13	0	0	463	0	0	0	0	468
% App. Total	.000	.250	.000	.750	.417	.750	.000	.000	13.2	.909	2.8	.000	.000	.851	.000	.000	.000	.000	.860
PHF																			

Peak Hour Analysis From 03:00 PM to 05:45 PM - Peak 1 of 1
Peak Hour for Entire Intersection Begins at 04:15 PM

Wilson Okamoto Corporation

1907 S. Beretania Street, Suite 400
Honolulu, HI 96826

Counted By:LS
Counter:D4-5677
Weather:Clear

File Name : WHindServ AM
Site Code : 00000002
Start Date : 9/9/2014
Page No : 1

Groups Printed- Unshifted

Start Time	Service Entrance Westbound				West Hind Drive Northbound				Eastbound							
	Left	Thru	Right	Peds	App. Total	Left	Thru	Right	Peds	App. Total	Left	Thru	Right	Peds	App. Total	Int. Total
06:00 AM	0	0	0	0	0	0	13	0	0	13	0	0	0	0	0	13
06:15 AM	0	0	0	0	0	0	30	1	0	31	0	0	0	0	0	31
06:30 AM	1	0	0	0	1	0	35	1	0	36	0	0	0	0	0	37
06:45 AM	0	0	0	0	0	0	39	0	0	39	0	0	0	0	0	39
Total	1	0	0	0	1	0	117	2	0	119	0	0	0	0	0	120
07:00 AM	0	0	0	0	0	0	47	2	0	49	0	0	0	0	0	50
07:15 AM	0	0	0	0	0	0	83	1	0	84	0	0	0	0	0	84
07:30 AM	0	0	0	0	0	0	118	1	0	119	0	0	0	0	0	119
07:45 AM	0	0	0	0	0	0	162	0	0	162	0	0	0	0	0	162
Total	1	0	0	0	1	0	410	4	0	414	0	0	0	0	0	415
08:00 AM	0	0	0	0	0	0	92	0	0	92	0	0	0	0	0	92
08:15 AM	0	0	0	0	0	0	71	3	0	74	0	0	0	0	0	74
08:30 AM	2	0	0	0	2	0	47	2	0	49	0	0	0	0	0	51
08:45 AM	1	0	1	0	2	0	65	1	0	66	0	0	0	0	0	68
Total	3	0	1	0	4	0	275	6	0	281	0	0	0	0	0	285
Grand Total	0	0	1	0	6	0	802	12	0	814	0	0	0	0	0	820
Approch %	83.3	0	16.7	0	0	0	98.5	1.5	0	99.3	0	0	0	0	0	0
Total %	0	0	0.1	0	0.7	0	97.8	1.5	0	99.3	0	0	0	0	0	0

Start Time	Service Entrance Westbound				West Hind Drive Northbound				Eastbound							
	Left	Thru	Right	Peds	App. Total	Left	Thru	Right	Peds	App. Total	Left	Thru	Right	Peds	App. Total	Int. Total
07:15 AM	0	0	0	0	0	0	83	1	0	84	0	0	0	0	0	84
07:30 AM	0	0	0	0	0	0	118	1	0	119	0	0	0	0	0	119
07:45 AM	0	0	0	0	0	0	162	0	0	162	0	0	0	0	0	162
08:00 AM	0	0	0	0	0	0	92	0	0	92	0	0	0	0	0	92
Total Volume	0	0	0	0	0	0	455	2	0	457	0	0	2	0	0	457
% App. Total	.000	.000	.000	.000	.000	.000	99.6	0.4	0	.705	.000	.705	.500	.000	.000	.705
PHF	.000	.000	.000	.000	.000	.000	.702	.500	.000	.705	.000	.705	.500	.000	.000	.705

Peak Hour Analysis From 06:00 AM to 08:45 AM - Peak 1 of 1
Peak Hour for Entire Intersection Begins at 07:15 AM

Wilson Okamoto Corporation

1907 S. Beretania Street, Suite 400
Honolulu, HI 96826

Counted By: IA
Counter: D4-5677
Weather: Clear

File Name : WHindServ PM
Site Code : 00000002
Start Date : 9/9/2014
Page No : 1

Groups Printed- Unshifted

Start Time	Service Entrance Westbound				West Hind Drive Northbound				Eastbound							
	Left	Thru	Right	Peds	App. Total	Left	Thru	Right	Peds	App. Total	Left	Thru	Right	Peds	App. Total	Int. Total
03:00 PM	3	0	0	0	3	0	61	0	0	61	0	0	0	0	0	64
03:15 PM	0	0	1	0	1	0	77	2	0	79	0	0	0	0	0	80
03:30 PM	2	0	1	0	3	0	81	4	0	85	0	0	0	0	0	88
03:45 PM	1	0	0	0	1	0	86	1	0	87	0	0	0	0	0	88
Total	6	0	2	0	8	0	305	7	0	312	0	0	0	0	0	320
04:00 PM	2	0	0	0	2	0	93	1	0	94	0	0	0	0	0	96
04:15 PM	1	0	1	0	2	0	134	0	0	134	0	0	0	0	0	136
04:30 PM	0	0	0	0	0	0	114	0	0	114	0	0	0	0	0	114
04:45 PM	1	0	1	0	2	0	108	1	0	109	0	0	0	0	0	111
Total	4	0	2	0	6	0	449	2	0	451	0	0	0	0	0	457
05:00 PM	0	0	0	0	0	0	102	0	0	102	0	0	0	0	0	102
05:15 PM	0	0	0	0	0	0	111	1	0	112	0	0	0	0	0	112
05:30 PM	0	0	0	0	0	0	79	1	0	80	0	0	0	0	0	80
05:45 PM	0	0	1	0	1	0	93	0	0	93	0	0	0	0	0	94
Total	0	0	1	0	1	0	385	2	0	387	0	0	0	0	0	388
06:00 PM	3	0	1	5	9	0	0	0	0	0	0	0	0	0	0	9
06:15 PM	0	0	0	0	0	0	0	0	0	0	0	0	0	0	0	0
Grand Total	13	0	6	5	24	0	1139	11	0	1150	0	0	0	0	0	1174
Approch %	54.2	0	25	20.8		0	99	1	0	98	0	0	0	0	0	
Total %	1.1	0	0.5	0.4	2	0	97	0.9	0	98	0	0	0	0	0	

Start Time	Service Entrance Westbound				West Hind Drive Northbound				Eastbound							
	Left	Thru	Right	Peds	App. Total	Left	Thru	Right	Peds	App. Total	Left	Thru	Right	Peds	App. Total	Int. Total
04:15 PM	1	0	0	1	2	0	134	0	0	134	0	0	0	0	0	136
04:30 PM	0	0	0	0	0	0	114	0	0	114	0	0	0	0	0	114
04:45 PM	1	0	1	1	2	0	108	1	0	109	0	0	0	0	0	111
05:00 PM	0	0	0	0	0	0	102	0	0	102	0	0	0	0	0	102
Total Volume	2	0	2	2	4	0	458	1	0	459	0	0	0	0	0	463
% App. Total	50	0	50	50		0	99.8	0.2	0		0	0	0	0	0	
PHF	.500	.000	.500	.500	.500	.000	.854	.250		.856	.000					.851

Peak Hour Analysis From 03:00 PM to 06:15 PM - Peak 1 of 1
Peak Hour for Entire Intersection Begins at 04:15 PM

Wilson Okamoto Corporation

1907 S. Beretania Street, Suite 400
Honolulu, HI 96826

Counted By: CK
Counter: D4-5672
Weather: Clear

File Name : WHinNen AM
Site Code : 00000001
Start Date : 9/9/2014
Page No : 1

Groups Printed- Unshifted

Start Time	West Hind Drive Southbound					Nenu Street Westbound					West Hind Drive Northbound					School Driveway Eastbound					
	Left	Thru	Right	Peds	App. Total	Left	Thru	Right	Peds	App. Total	Left	Thru	Right	Peds	App. Total	Left	Thru	Right	Peds	App. Total	Int. Total
	06:00 AM	0	62	0	0	62	2	0	0	0	2	0	7	2	0	9	0	0	0	0	0
06:15 AM	2	87	1	0	90	0	0	0	0	0	2	22	4	0	28	0	0	2	1	3	121
06:30 AM	4	100	0	0	104	3	0	1	0	4	7	19	3	0	29	0	0	5	1	6	143
06:45 AM	2	101	2	0	105	4	1	1	0	6	5	24	2	0	31	1	0	3	0	4	146
Total	8	350	3	0	361	9	1	2	0	12	14	72	11	0	97	1	0	10	2	13	483
07:00 AM	3	62	2	0	67	1	1	1	0	3	8	19	3	0	30	0	0	7	1	8	108
07:15 AM	2	71	10	0	83	0	1	0	0	1	13	28	7	0	48	4	2	8	1	15	147
07:30 AM	4	75	21	0	100	0	1	2	0	3	13	39	8	0	60	6	4	14	1	25	188
07:45 AM	1	79	34	0	114	4	0	3	0	7	29	41	8	0	78	12	6	26	2	46	245
Total	10	287	67	0	364	5	3	6	0	14	63	127	26	0	216	22	12	55	5	94	688
08:00 AM	1	49	4	0	54	6	2	1	0	9	5	55	11	0	71	10	5	24	1	40	174
08:15 AM	0	48	0	0	48	1	0	2	0	3	2	46	7	0	55	1	0	2	0	3	109
08:30 AM	1	52	0	0	53	2	0	0	0	2	1	32	1	0	34	2	0	1	0	3	92
08:45 AM	0	54	1	0	55	6	0	3	0	9	1	54	3	0	58	1	0	1	0	2	124
Total	2	203	5	0	210	15	2	6	0	23	9	187	22	0	218	14	5	28	1	48	499
Grand Total	20	840	75	0	935	29	6	14	0	49	86	386	59	0	531	37	17	93	8	155	1670
Apprch %	2.1	89.8	8	0		59.2	12.2	28.6	0		16.2	72.7	11.1	0		23.9	11	60	5.2		
Total %	1.2	50.3	4.5	0	56	1.7	0.4	0.8	0	2.9	5.1	23.1	3.5	0	31.8	2.2	1	5.6	0.5	9.3	

Start Time	West Hind Drive Southbound					Nenu Street Westbound					West Hind Drive Northbound					School Driveway Eastbound					
	Left	Thru	Right	Peds	App. Total	Left	Thru	Right	Peds	App. Total	Left	Thru	Right	Peds	App. Total	Left	Thru	Right	Peds	App. Total	Int. Total
	07:15 AM	2	71	10	0	83	0	1	0	0	1	13	28	7	0	48	4	2	8	0	14
07:30 AM	4	75	21	0	100	0	1	2	0	3	13	39	8	0	60	6	4	14	0	24	187
07:45 AM	1	79	34	0	114	4	0	3	0	7	29	41	8	0	78	12	6	26	0	44	243
08:00 AM	1	49	4	0	54	6	2	1	0	9	5	55	11	0	71	10	5	24	0	39	173
Total Volume	8	274	69	0	351	10	4	6	0	20	60	163	34	0	257	32	17	72	0	121	749
% App. Total	2.3	78.1	19.7	0		50	20	30	0		23.3	63.4	13.2	0		26.4	14	59.5	0		
PHF	.500	.867	.507	0	.770	.417	.500	.500	0	.556	.517	.741	.773	0	.824	.667	.708	.692	0	.688	.771

Peak Hour Analysis From 06:00 AM to 08:45 AM - Peak 1 of 1
Peak Hour for Entire Intersection Begins at 07:15 AM

Wilson Okamoto Corporation

1907 S. Beretania Street, Suite 400
Honolulu, HI 96826

Counted By: CK
Counter: D4-5672
Weather: Clear

File Name : WHinNen PM
Site Code : 00000001
Start Date : 9/9/2014
Page No : 1

Groups Printed- Unshifted

Start Time	West Hind Drive Southbound				Nenu Street Westbound				West Hind Drive Northbound				School Driveway Eastbound								
	Left	Thru	Right	Peds	App. Total	Left	Thru	Right	Peds	App. Total	Left	Thru	Right	Peds	App. Total	Left	Thru	Right	Peds	App. Total	Int. Total
03:00 PM	0	38	0	0	38	2	0	1	0	3	53	2	0	0	58	2	0	1	1	4	103
03:15 PM	1	40	5	0	46	2	2	1	0	5	57	6	0	0	69	2	4	5	0	11	131
03:30 PM	1	39	1	0	41	5	0	4	0	9	68	7	0	0	80	5	0	1	0	6	136
03:45 PM	1	35	1	0	37	0	0	1	0	1	67	4	0	0	78	4	0	5	0	9	125
Total	3	152	7	0	162	9	2	7	0	18	245	19	0	0	285	13	4	12	1	30	495
04:00 PM	0	24	1	0	25	2	0	3	0	5	57	8	0	0	74	3	3	3	0	9	113
04:15 PM	2	33	1	0	36	1	1	3	0	5	88	10	0	0	107	0	5	3	1	9	157
04:30 PM	1	31	0	0	32	0	0	2	0	2	81	11	0	0	98	10	0	3	4	17	149
04:45 PM	1	28	3	0	32	2	0	1	0	3	83	5	0	0	97	5	1	3	1	10	142
Total	4	116	5	0	125	5	1	9	0	15	309	34	0	0	376	18	9	12	6	45	561
05:00 PM	1	34	1	0	36	0	0	0	0	0	73	6	0	0	92	5	2	5	0	12	140
05:15 PM	0	39	5	0	44	1	0	3	0	4	80	5	0	0	97	9	4	3	0	16	161
05:30 PM	3	35	0	0	38	1	0	1	0	2	73	0	0	0	75	5	0	7	3	15	130
05:45 PM	5	52	1	0	58	1	0	3	0	4	86	3	0	0	89	2	2	3	2	9	160
Total	9	160	7	0	176	3	0	7	0	10	312	14	0	0	353	21	8	18	5	52	591
Grand Total	16	428	19	0	463	17	3	23	0	43	866	67	0	0	1014	52	21	42	12	127	1647
Approach %	3.5	92.4	4.1	0		39.5	7	53.5	0		8	85.4	6.6	0		40.9	16.5	33.1	9.4		
Total %	1	26	1.2	0	28.1	1	0.2	1.4	0	2.6	4.9	52.6	4.1	0	61.6	3.2	1.3	2.6	0.7	7.7	

Start Time	West Hind Drive Southbound				Nenu Street Westbound				West Hind Drive Northbound				School Driveway Eastbound								
	Left	Thru	Right	Peds	App. Total	Left	Thru	Right	Peds	App. Total	Left	Thru	Right	Peds	App. Total	Left	Thru	Right	Peds	App. Total	Int. Total
04:30 PM	1	31	0	0	32	0	0	2	0	2	81	11	0	0	98	10	0	3	0	13	145
04:45 PM	1	28	3	0	32	2	0	1	0	3	83	5	0	0	97	5	1	3	0	9	141
05:00 PM	1	34	1	0	36	0	0	0	0	0	73	6	0	0	92	5	2	5	0	12	140
05:15 PM	0	39	5	0	44	1	0	3	0	4	80	5	0	0	97	9	4	3	0	16	161
Total Volume	3	132	9	0	144	3	0	6	0	9	317	27	0	0	384	29	7	14	0	50	587
% App. Total	2.1	91.7	6.2	0		33.3	0	66.7	0		10.4	82.6	7	0		58	14	28	0		
PHF	.750	.846	.450		.818	.375	.000	.500		.563	.769	.614			.980	.725	.438	.700		.781	.911

Peak Hour Analysis From 03:00 PM to 05:45 PM - Peak 1 of 1

Peak Hour for Entire Intersection Begins at 04:30 PM

APPENDIX B

LEVEL OF SERVICE DEFINITIONS

LEVEL OF SERVICE DEFINITIONS

LEVEL-OF-SERVICE CRITERIA FOR SIGNALIZED INTERSECTIONS

Level of Service (LOS) for signalized intersections is defined in terms of delay, which is a measure of driver discomfort, frustration, fuel consumption, and increased travel time. Specifically, level-of-service (LOS) criteria are stated in terms of the average control delay per vehicle, typically a 15-min analysis period. The criteria are given in the following table.

Table 1: Level-of-Service Criteria for Signalized Intersections

Level of Service	Control Delay per Vehicle (sec/veh)
A	≤ 10.0
B	>10.0 and ≤ 20.0
C	>20.0 and ≤ 35.0
D	>35.0 and ≤ 55.0
E	>55.0 and ≤ 80.0
F	>80.0

Delay is a complex measure and depends on a number of variables, including the quality of progression, the cycle length, the green ratio, and the v/c ratio for the lane group.

Level of Service A describes operations with low control delay, up to 10 sec per vehicle. This level of service occurs when progression is extremely favorable and most vehicles arrive during the green phase. Many vehicles do not stop at all. Short cycle lengths may tend to contribute to low delay values.

Level of Service B describes operations with control delay greater than 10 and up to 20 sec per vehicle. This level generally occurs with good progression, short cycle lengths, or both. More vehicles stop than with LOS A, causing higher levels of delay.

Level of Service C describes operations with control delay greater than 20 and up to 35 sec per vehicle. These higher delays may result from only fair progression, longer cycle lengths, or both. Individual cycle failures may begin to appear at this level. Cycle failure occurs when a given green phase does not serve queued vehicles and overflows occur. The number of vehicles stopping is significant at this level, though many still pass through the intersection without stopping.

Level of Service D describes operations with control delay greater than 35 and up to 55 sec per vehicle. At level of service D, the influence of congestion becomes more noticeable. Longer delays may result from some combination of unfavorable progression, long cycle lengths, or high v/c ratios. Many vehicles stop, and the proportion of vehicles not stopping declines. Individual cycle failures are noticeable.

Level of Service E describes operation with control delay greater than 55 and up to 80 sec per vehicle. These high delay values generally indicate poor progression, long cycle lengths, and high v/c ratios. Individual cycle failures are frequent.

Level of Service F describes operations with control delay in excess of 80 sec per vehicle. This level, considered to be unacceptable to most drivers, often occurs with oversaturation, that is, when arrival flow rates exceed the capacity lane groups. It may also occur at high v/c ratios with many individual cycle failures. Poor progression and long cycle lengths may also contribute significantly to high delay levels.

LEVEL OF SERVICE DEFINITIONS

LEVEL-OF-SERVICE CRITERIA FOR UNSIGNALIZED INTERSECTIONS

Level of Service (LOS) criteria are given in Table 1. As used here, control delay is defined as the total elapsed time from the time a vehicle stops at the end of the queue to the time required for the vehicle to travel from the last-in-queue position to the first-in-queue position, including deceleration of vehicles from free-flow speed to the speed of vehicles in the queue.

The average total delay for any particular minor movement is a function of the service rate or capacity of the approach and the degree of saturation. If the degree of saturation is greater than about 0.9, average control delay is significantly affected by the length of the analysis period.

**Table 1: Level-of-Service Criteria for
Unsignalized Intersections**

Level of Service	Average Control Delay (Sec/Veh)
A	≤ 10.0
B	>10.0 and ≤ 15.0
C	>15.0 and ≤ 25.0
D	>25.0 and ≤ 35.0
E	>35.0 and ≤ 50.0
F	>50.0

APPENDIX C

**CAPACITY ANALYSIS CALCULATIONS
EXISTING PEAK HOUR TRAFFIC ANALYSIS**

HCM Signalized Intersection Capacity Analysis
 4: Church Dwy/Nenu St & Kalaniana'ole Hwy

10/7/2014



Movement	EBL	EBT	EBR	WBL	WBT	WBR	NBL	NBT	NBR	SBL	SBT	SBR
Lane Configurations		↑↑			↑↑↑			↔			↔	↗
Volume (vph)	0	977	18	0	4292	145	0	4	1	76	2	54
Ideal Flow (vphpl)	1900	1900	1900	1900	1900	1900	1900	1900	1900	1900	1900	1900
Total Lost time (s)		5.0			5.0			5.0			5.0	5.0
Lane Util. Factor		0.95			0.86			1.00			1.00	1.00
Frbp, ped/bikes		1.00			1.00			1.00			1.00	0.93
Flpb, ped/bikes		1.00			1.00			1.00			1.00	1.00
Frt		1.00			1.00			0.97			1.00	0.85
Flt Protected		1.00			1.00			1.00			0.95	1.00
Satd. Flow (prot)		3529			6376			1812			1776	1476
Flt Permitted		1.00			1.00			1.00			0.73	1.00
Satd. Flow (perm)		3529			6376			1812			1357	1476
Peak-hour factor, PHF	0.96	0.96	0.96	0.96	0.96	0.96	0.96	0.96	0.96	0.96	0.96	0.96
Adj. Flow (vph)	0	1018	19	0	4471	151	0	4	1	79	2	56
RTOR Reduction (vph)	0	0	0	0	2	0	0	1	0	0	0	8
Lane Group Flow (vph)	0	1037	0	0	4620	0	0	4	0	0	81	48
Confl. Peds. (#/hr)												13
Turn Type		NA			NA			NA		Perm	NA	Perm
Protected Phases		2			6			8			4	
Permitted Phases							8			4		4
Actuated Green, G (s)		204.1			204.1			18.9			18.9	18.9
Effective Green, g (s)		204.1			204.1			18.9			18.9	18.9
Actuated g/C Ratio		0.88			0.88			0.08			0.08	0.08
Clearance Time (s)		5.0			5.0			5.0			5.0	5.0
Vehicle Extension (s)		3.0			3.0			3.0			3.0	3.0
Lane Grp Cap (vph)		3091			5585			146			110	119
v/s Ratio Prot		0.29			c0.72			0.00				
v/s Ratio Perm											c0.06	0.03
v/c Ratio		0.34			0.83			0.03			0.74	0.40
Uniform Delay, d1		2.5			6.5			98.6			104.6	101.7
Progression Factor		1.00			1.00			1.00			1.00	1.00
Incremental Delay, d2		0.1			1.1			0.1			22.4	2.2
Delay (s)		2.6			7.6			98.7			127.0	103.9
Level of Service		A			A			F			F	F
Approach Delay (s)		2.6			7.6			98.7			117.5	
Approach LOS		A			A			F			F	

Intersection Summary			
HCM 2000 Control Delay	9.4	HCM 2000 Level of Service	A
HCM 2000 Volume to Capacity ratio	0.82		
Actuated Cycle Length (s)	233.0	Sum of lost time (s)	10.0
Intersection Capacity Utilization	88.2%	ICU Level of Service	E
Analysis Period (min)	15		

c Critical Lane Group

HCM Unsignalized Intersection Capacity Analysis

5: W Hind Dr & School Exit/Shopping Ctr Dwy

10/7/2014



Movement	EBL	EBT	EBR	WBL	WBT	WBR	NBL	NBT	NBR	SBL	SBT	SBR
Lane Configurations		↔			↔			↑↔			↔↑	
Volume (veh/h)	8	7	17	63	0	37	0	170	10	42	318	0
Sign Control		Stop			Stop			Free			Free	
Grade		0%			0%			0%			0%	
Peak Hour Factor	0.87	0.87	0.87	0.87	0.87	0.87	0.87	0.87	0.87	0.87	0.87	0.87
Hourly flow rate (vph)	9	8	20	72	0	43	0	195	11	48	366	0
Pedestrians											11	
Lane Width (ft)											12.0	
Walking Speed (ft/s)											4.0	
Percent Blockage											1	
Right turn flare (veh)												
Median type								None			None	
Median storage veh												
Upstream signal (ft)								274				
pX, platoon unblocked												
vC, conflicting volume	613	669	183	504	663	114	366			207		
vC1, stage 1 conf vol												
vC2, stage 2 conf vol												
vCu, unblocked vol	613	669	183	504	663	114	366			207		
tC, single (s)	*6.5	*5.5	*5.9	*6.5	6.5	*5.9	4.1			4.1		
tC, 2 stage (s)												
tF (s)	3.5	4.0	3.3	3.5	4.0	3.3	2.2			2.2		
p0 queue free %	98	98	98	85	100	95	100			96		
cM capacity (veh/h)	414	441	873	489	367	938	1190			1362		

Direction, Lane #	EB 1	WB 1	NB 1	NB 2	SB 1	SB 2
Volume Total	37	115	130	77	170	244
Volume Left	9	72	0	0	48	0
Volume Right	20	43	0	11	0	0
cSH	585	594	1700	1700	1362	1700
Volume to Capacity	0.06	0.19	0.08	0.05	0.04	0.14
Queue Length 95th (ft)	5	18	0	0	3	0
Control Delay (s)	11.6	12.5	0.0	0.0	2.4	0.0
Lane LOS	B	B			A	
Approach Delay (s)	11.6	12.5	0.0		1.0	
Approach LOS	B	B				

Intersection Summary		
Average Delay		2.9
Intersection Capacity Utilization	38.0%	ICU Level of Service
Analysis Period (min)		15
		A

* User Entered Value

HCM Signalized Intersection Capacity Analysis
 6: Kalaniana'ole Hwy & W Hind Dr

10/7/2014



Movement	EBL	EBT	WBT	WBR	SBL	SBR
Lane Configurations						
Volume (vph)	199	989	4275	71	0	431
Ideal Flow (vphpl)	1900	1900	1900	1900	1900	1900
Total Lost time (s)	5.0	5.0	5.0	5.0		5.0
Lane Util. Factor	0.97	0.95	0.86	1.00		0.88
Frbp, ped/bikes	1.00	1.00	1.00	0.98		1.00
Ftpb, ped/bikes	1.00	1.00	1.00	1.00		1.00
Frt	1.00	1.00	1.00	0.85		0.85
Flt Protected	0.95	1.00	1.00	1.00		1.00
Satd. Flow (prot)	3433	3539	6408	1558		2787
Flt Permitted	0.95	1.00	1.00	1.00		1.00
Satd. Flow (perm)	3433	3539	6408	1558		2787
Peak-hour factor, PHF	0.95	0.95	0.95	0.95	0.95	0.95
Adj. Flow (vph)	209	1041	4500	75	0	454
RTOR Reduction (vph)	0	0	0	5	0	85
Lane Group Flow (vph)	209	1041	4500	70	0	369
Confl. Peds. (#/hr)				1		1
Turn Type	Prot	NA	NA	Perm		Over
Protected Phases	5	2	6			5
Permitted Phases				6		5
Actuated Green, G (s)	35.2	233.3	188.1	188.1		35.2
Effective Green, g (s)	35.2	233.3	188.1	188.1		35.2
Actuated g/C Ratio	0.15	1.00	0.81	0.81		0.15
Clearance Time (s)	5.0	5.0	5.0	5.0		5.0
Vehicle Extension (s)	3.0	3.0	3.0	3.0		3.0
Lane Grp Cap (vph)	517	3539	5166	1256		420
v/s Ratio Prot	0.06	0.29	c0.70			c0.13
v/s Ratio Perm				0.04		
v/c Ratio	0.40	0.29	0.87	0.06		0.88
Uniform Delay, d1	89.6	0.0	14.7	4.6		97.0
Progression Factor	1.00	1.00	1.00	1.00		1.00
Incremental Delay, d2	0.5	0.0	1.8	0.0		18.4
Delay (s)	90.1	0.0	16.5	4.6		115.4
Level of Service	F	A	B	A		F
Approach Delay (s)		15.1	16.3		115.4	
Approach LOS		B	B		F	

Intersection Summary			
HCM 2000 Control Delay	23.2	HCM 2000 Level of Service	C
HCM 2000 Volume to Capacity ratio	0.87		
Actuated Cycle Length (s)	233.3	Sum of lost time (s)	10.0
Intersection Capacity Utilization	85.5%	ICU Level of Service	E
Analysis Period (min)	15		

c Critical Lane Group

HCM Unsignalized Intersection Capacity Analysis

8: W Hind Dr & Church Dwy/Shopping Center Dwy

10/8/2014



Movement	EBL	EBT	EBR	WBL	WBT	WBR	NBL	NBT	NBR	SBL	SBT	SBR
Lane Configurations		↔			↔			↑↑			↔	
Volume (veh/h)	0	0	0	40	0	18	0	163	107	6	391	1
Sign Control		Stop			Stop			Free			Free	
Grade		0%			0%			0%			0%	
Peak Hour Factor	0.93	0.93	0.93	0.93	0.93	0.93	0.93	0.93	0.93	0.93	0.93	0.93
Hourly flow rate (vph)	0	0	0	43	0	19	0	175	115	6	420	1
Pedestrians		4										
Lane Width (ft)		12.0										
Walking Speed (ft/s)		4.0										
Percent Blockage		0										
Right turn flare (veh)												
Median type								None			None	
Median storage (veh)												
Upstream signal (ft)								144				
pX, platoon unblocked												
vC, conflicting volume	545	728	215	456	671	145	426			290		
vC1, stage 1 conf vol												
vC2, stage 2 conf vol												
vCu, unblocked vol	545	728	215	456	671	145	426			290		
tC, single (s)	7.5	6.5	6.9	*6.5	6.5	*5.9	4.1			4.1		
tC, 2 stage (s)												
tF (s)	3.5	4.0	3.3	3.5	4.0	3.3	2.2			2.2		
p0 queue free %	100	100	100	92	100	98	100			99		
cM capacity (veh/h)	408	346	787	553	373	913	1126			1268		

Direction, Lane #	EB 1	WB 1	NB 1	NB 2	SB 1	SB 2
Volume Total	0	62	117	173	217	211
Volume Left	0	43	0	0	6	0
Volume Right	0	19	0	115	0	1
cSH	1700	630	1700	1700	1268	1700
Volume to Capacity	0.00	0.10	0.07	0.10	0.01	0.12
Queue Length 95th (ft)	0	8	0	0	0	0
Control Delay (s)	0.0	11.3	0.0	0.0	0.3	0.0
Lane LOS	A	B			A	
Approach Delay (s)	0.0	11.3	0.0		0.1	
Approach LOS	A	B				

Intersection Summary		
Average Delay		1.0
Intersection Capacity Utilization	25.1%	ICU Level of Service A
Analysis Period (min)		15

* User Entered Value

HCM Signalized Intersection Capacity Analysis

18: Wailupe Cir & Kalaniana'ole Hwy

10/8/2014

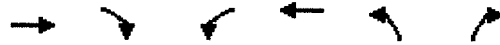

Movement	EBT	EBR	WBL	WBT	NBL	NBR
Lane Configurations	↑↑	↗	↘	↑↑↑	↖	↗
Volume (vph)	1180	15	9	4697	56	8
Ideal Flow (vphpl)	1900	1900	1900	1900	1900	1900
Total Lost time (s)	5.0	5.0	5.0	5.0	5.0	5.0
Lane Util. Factor	0.95	1.00	1.00	0.86	1.00	1.00
Frbp, ped/bikes	1.00	0.97	1.00	1.00	1.00	1.00
Flpb, ped/bikes	1.00	1.00	1.00	1.00	1.00	1.00
Frt	1.00	0.85	1.00	1.00	1.00	0.85
Flt Protected	1.00	1.00	0.95	1.00	0.95	1.00
Satd. Flow (prot)	3539	1528	1770	6408	1770	1583
Flt Permitted	1.00	1.00	0.95	1.00	0.95	1.00
Satd. Flow (perm)	3539	1528	1770	6408	1770	1583
Peak-hour factor, PHF	0.94	0.94	0.94	0.94	0.94	0.94
Adj. Flow (vph)	1255	16	10	4997	60	9
RTOR Reduction (vph)	0	2	0	0	0	9
Lane Group Flow (vph)	1255	14	10	4997	60	0
Confl. Peds. (#/hr)		2				
Turn Type	NA	Perm	Prot	NA	Prot	Perm
Protected Phases	2		1	6	8	
Permitted Phases		2				8
Actuated Green, G (s)	208.8	208.8	3.3	217.1	12.9	12.9
Effective Green, g (s)	208.8	208.8	3.3	217.1	12.9	12.9
Actuated g/C Ratio	0.87	0.87	0.01	0.90	0.05	0.05
Clearance Time (s)	5.0	5.0	5.0	5.0	5.0	5.0
Vehicle Extension (s)	3.0	3.0	3.0	3.0	3.0	3.0
Lane Grp Cap (vph)	3078	1329	24	5796	95	85
v/s Ratio Prot	0.35		0.01	c0.78	c0.03	
v/s Ratio Perm		0.01				0.00
v/c Ratio	0.41	0.01	0.42	0.86	0.63	0.01
Uniform Delay, d1	3.1	2.0	117.4	5.0	111.2	107.5
Progression Factor	1.00	1.00	1.00	1.00	1.00	1.00
Incremental Delay, d2	0.1	0.0	11.3	1.5	12.9	0.0
Delay (s)	3.2	2.0	128.7	6.4	124.1	107.5
Level of Service	A	A	F	A	F	F
Approach Delay (s)	3.2			6.7	122.0	
Approach LOS	A			A	F	

Intersection Summary			
HCM 2000 Control Delay	7.2	HCM 2000 Level of Service	A
HCM 2000 Volume to Capacity ratio	0.87		
Actuated Cycle Length (s)	240.0	Sum of lost time (s)	15.0
Intersection Capacity Utilization	79.7%	ICU Level of Service	D
Analysis Period (min)	15		

c Critical Lane Group

HCM Unsignalized Intersection Capacity Analysis

19: W Hind Dr & Makalena St

11/28/2014



Movement	EBL	EBT	EBR	WBL	WBT	WBR	NBL	NBT	NBR	SBL	SBT	SBR
Lane Configurations					↕			↕			↕	
Volume (veh/h)	0	0	0	5	0	3	59	145	7	0	356	11
Sign Control		Stop			Stop			Free			Free	
Grade		0%			0%			0%			0%	
Peak Hour Factor	0.89	0.89	0.89	0.89	0.89	0.89	0.89	0.89	0.89	0.89	0.89	0.89
Hourly flow rate (vph)	0	0	0	6	0	3	66	163	8	0	400	12
Pedestrians		6			18						2	
Lane Width (ft)		0.0			12.0						12.0	
Walking Speed (ft/s)		4.0			4.0						4.0	
Percent Blockage		0			1						0	
Right turn flare (veh)												
Median type								None			None	
Median storage veh												
Upstream signal (ft)								568				
pX, platoon unblocked												
vC, conflicting volume	632	734	412	724	736	105	418			189		
vC1, stage 1 conf vol												
vC2, stage 2 conf vol												
vCu, unblocked vol	632	734	412	724	736	105	418			189		
tC, single (s)	7.5	6.5	6.9	*6.5	6.5	*5.9	4.1			4.1		
tC, 2 stage (s)												
tF (s)	3.5	4.0	3.3	3.5	4.0	3.3	2.2			2.2		
p0 queue free %	100	100	100	98	100	100	94			100		
cM capacity (veh/h)	343	321	589	359	320	941	1137			1362		

Direction, Lane #	WB 1	NB 1	NB 2	SB 1
Volume Total	9	148	89	412
Volume Left	6	66	0	0
Volume Right	3	0	8	12
cSH	468	1137	1700	1362
Volume to Capacity	0.02	0.06	0.05	0.00
Queue Length 95th (ft)	1	5	0	0
Control Delay (s)	12.8	4.0	0.0	0.0
Lane LOS	B	A		
Approach Delay (s)	12.8	2.5		0.0
Approach LOS	B			

Intersection Summary			
Average Delay		1.1	
Intersection Capacity Utilization	42.7%	ICU Level of Service	A
Analysis Period (min)	15		

* User Entered Value

HCM Unsignalized Intersection Capacity Analysis
 20: W Hind Dr & School Dwy/Nenuc St

10/7/2014



Movement	EBL	EBT	EBR	WBL	WBT	WBR	NBL	NBT	NBR	SBL	SBT	SBR
Lane Configurations		↔			↔			↔			↔	
Volume (veh/h)	5	2	23	8	3	3	33	100	15	11	336	14
Sign Control		Stop			Stop			Free			Free	
Grade		0%			0%			0%			0%	
Peak Hour Factor	0.93	0.93	0.93	0.93	0.93	0.93	0.93	0.93	0.93	0.93	0.93	0.93
Hourly flow rate (vph)	5	2	25	9	3	3	35	108	16	12	361	15
Pedestrians		3										
Lane Width (ft)		12.0										
Walking Speed (ft/s)		4.0										
Percent Blockage		0										
Right turn flare (veh)												
Median type								None			None	
Median storage veh												
Upstream signal (ft)								854				
pX, platoon unblocked												
vC, conflicting volume	587	590	372	605	590	116	379			124		
vC1, stage 1 conf vol												
vC2, stage 2 conf vol												
vCu, unblocked vol	587	590	372	605	590	116	379			124		
tC, single (s)	*6.1	*5.5	*5.2	*6.1	*5.5	*5.2	4.1			4.1		
tC, 2 stage (s)												
tF (s)	3.5	4.0	3.3	3.5	4.0	3.3	2.2			2.2		
p0 queue free %	99	100	97	98	99	100	97			99		
cM capacity (veh/h)	477	476	747	454	477	968	1176			1463		

Direction, Lane #	EB 1	WB 1	NB 1	SB 1
Volume Total	32	15	159	388
Volume Left	5	9	35	12
Volume Right	25	3	16	15
cSH	660	518	1176	1463
Volume to Capacity	0.05	0.03	0.03	0.01
Queue Length 95th (ft)	4	2	2	1
Control Delay (s)	10.7	12.2	2.0	0.3
Lane LOS	B	B	A	A
Approach Delay (s)	10.7	12.2	2.0	0.3
Approach LOS	B	B		

Intersection Summary			
Average Delay		1.6	
Intersection Capacity Utilization	32.8%	ICU Level of Service	A
Analysis Period (min)	15		

* User Entered Value

HCM Signalized Intersection Capacity Analysis

4: Church Dwy/Nenu St & Kalaniana'ole Hwy

10/7/2014



Movement	EBU	EBL	EBT	EBR	WBL	WBT	WBR	NBL	NBT	NBR	SBL	SBT
Lane Configurations		↔	↑↑↑		↔	↑↑↑			↕			↕
Volume (vph)	7	11	3028	2	7	1554	97	0	0	0	210	1
Ideal Flow (vphpl)	1900	1900	1900	1900	1900	1900	1900	1900	1900	1900	1900	1900
Total Lost time (s)		5.0	5.0		5.0	5.0						5.0
Lane Util. Factor		1.00	0.91		1.00	0.91						1.00
Frbp, ped/bikes		1.00	1.00		1.00	1.00						1.00
Flpb, ped/bikes		1.00	1.00		1.00	1.00						1.00
Frt		1.00	1.00		1.00	0.99						1.00
Flt Protected		0.95	1.00		0.95	1.00						0.95
Satd. Flow (prot)		1770	5085		1770	5031						1774
Flt Permitted		0.95	1.00		0.95	1.00						0.73
Satd. Flow (perm)		1770	5085		1770	5031						1355
Peak-hour factor, PHF	0.95	0.95	0.95	0.95	0.95	0.95	0.95	0.95	0.95	0.95	0.95	0.95
Adj. Flow (vph)	7	12	3187	2	7	1636	102	0	0	0	221	1
RTOR Reduction (vph)	0	0	0	0	0	3	0	0	0	0	0	0
Lane Group Flow (vph)	0	19	3189	0	7	1735	0	0	0	0	0	222
Confl. Peds. (#/hr)							3					
Turn Type	Prot	Prot	NA		Prot	NA					Perm	NA
Protected Phases	5	5	2		1	6			8			4
Permitted Phases								8			4	
Actuated Green, G (s)		3.1	87.9		1.3	86.1						26.3
Effective Green, g (s)		3.1	87.9		1.3	86.1						26.3
Actuated g/C Ratio		0.02	0.67		0.01	0.66						0.20
Clearance Time (s)		5.0	5.0		5.0	5.0						5.0
Vehicle Extension (s)		3.0	3.0		3.0	3.0						3.0
Lane Grp Cap (vph)		42	3425		17	3319						273
v/s Ratio Prot		c0.01	c0.63		0.00	0.34						
v/s Ratio Perm												c0.16
v/c Ratio		0.45	0.93		0.41	0.52						0.81
Uniform Delay, d1		62.9	18.6		64.2	11.5						49.8
Progression Factor		1.00	1.00		1.00	1.00						1.00
Incremental Delay, d2		7.6	5.4		15.4	0.1						16.7
Delay (s)		70.4	24.0		79.6	11.7						66.4
Level of Service		E	C		E	B						E
Approach Delay (s)			24.3			12.0			0.0			63.2
Approach LOS			C			B			A			E

Intersection Summary			
HCM 2000 Control Delay	22.1	HCM 2000 Level of Service	C
HCM 2000 Volume to Capacity ratio	0.91		
Actuated Cycle Length (s)	130.5	Sum of lost time (s)	15.0
Intersection Capacity Utilization	78.8%	ICU Level of Service	D
Analysis Period (min)	15		

c Critical Lane Group

HCM Signalized Intersection Capacity Analysis
 4: Church Dwy/Nenu St & Kalaniana'ole Hwy

10/7/2014



Movement	SBR
Lane Configurations	7
Volume (vph)	31
Ideal Flow (vphpl)	1900
Total Lost time (s)	5.0
Lane Util. Factor	1.00
Frbp, ped/bikes	0.98
Fipb, ped/bikes	1.00
Frt	0.85
Flt Protected	1.00
Satd. Flow (prot)	1545
Flt Permitted	1.00
Satd. Flow (perm)	1545
Peak-hour factor, PHF	0.95
Adj. Flow (vph)	33
RTOR Reduction (vph)	26
Lane Group Flow (vph)	7
Confl. Peds. (#/hr)	5
Turn Type	Perm
Protected Phases	
Permitted Phases	4
Actuated Green, G (s)	26.3
Effective Green, g (s)	26.3
Actuated g/C Ratio	0.20
Clearance Time (s)	5.0
Vehicle Extension (s)	3.0
Lane Grp Cap (vph)	311
v/s Ratio Prot	
v/s Ratio Perm	0.00
v/c Ratio	0.02
Uniform Delay, d1	41.8
Progression Factor	1.00
Incremental Delay, d2	0.0
Delay (s)	41.8
Level of Service	D
Approach Delay (s)	
Approach LOS	
Intersection Summary	

HCM Unsignalized Intersection Capacity Analysis
 5: W Hind Dr & School Exit/Shopping Ctr Dwy

10/7/2014



Movement	EBL	EBT	EBR	WBL	WBT	WBR	NBL	NBT	NBR	SBL	SBT	SBR
Lane Configurations		↔			↔			↑↔			↔↑	
Volume (veh/h)	10	7	23	67	0	53	0	315	124	34	138	0
Sign Control		Stop			Stop			Free			Free	
Grade		0%			0%			0%			0%	
Peak Hour Factor	0.94	0.94	0.94	0.94	0.94	0.94	0.94	0.94	0.94	0.94	0.94	0.94
Hourly flow rate (vph)	11	7	24	71	0	56	0	335	132	36	147	0
Pedestrians		5									16	
Lane Width (ft)		12.0									12.0	
Walking Speed (ft/s)		4.0									4.0	
Percent Blockage		0									1	
Right turn flare (veh)												
Median type								None			None	
Median storage veh												
Upstream signal (ft)								274				
pX, platoon unblocked												
vC, conflicting volume	464	691	78	575	625	250	152			467		
vC1, stage 1 conf vol												
vC2, stage 2 conf vol												
vCu, unblocked vol	464	691	78	575	625	250	152			467		
tC, single (s)	*6.5	*5.5	*5.9	*6.5	6.5	*5.9	4.1			4.1		
tC, 2 stage (s)												
tF (s)	3.5	4.0	3.3	3.5	4.0	3.3	2.2			2.2		
p0 queue free %	98	98	98	84	100	93	100			97		
cM capacity (veh/h)	488	430	984	443	385	796	1421			1091		

Direction, Lane #	EB 1	WB 1	NB 1	NB 2	SB 1	SB 2
Volume Total	43	128	223	244	85	98
Volume Left	11	71	0	0	36	0
Volume Right	24	56	0	132	0	0
cSH	665	551	1700	1700	1091	1700
Volume to Capacity	0.06	0.23	0.13	0.14	0.03	0.06
Queue Length 95th (ft)	5	22	0	0	3	0
Control Delay (s)	10.8	13.5	0.0	0.0	3.7	0.0
Lane LOS	B	B			A	
Approach Delay (s)	10.8	13.5	0.0		1.7	
Approach LOS	B	B				

Intersection Summary		
Average Delay		3.0
Intersection Capacity Utilization	42.4%	ICU Level of Service
Analysis Period (min)		15
		A

* User Entered Value

HCM Signalized Intersection Capacity Analysis
 6: Kalaniana'ole Hwy & W Hind Dr

10/7/2014

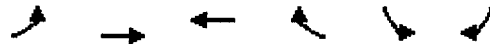

Movement	EBL	EBT	WBT	WBR	SBL	SBR
Lane Configurations	↖↖	↑↑↑	↑↑↑	↗		↘↘
Volume (vph)	557	3041	1541	51	0	302
Ideal Flow (vphpl)	1900	1900	1900	1900	1900	1900
Total Lost time (s)	5.0	5.0	5.0	5.0		5.0
Lane Util. Factor	0.97	0.91	0.91	1.00		0.88
Frbp, ped/bikes	1.00	1.00	1.00	0.96		1.00
Flpb, ped/bikes	1.00	1.00	1.00	1.00		1.00
Frt	1.00	1.00	1.00	0.85		0.85
Flt Protected	0.95	1.00	1.00	1.00		1.00
Satd. Flow (prot)	3433	5085	5085	1528		2787
Flt Permitted	0.95	1.00	1.00	1.00		1.00
Satd. Flow (perm)	3433	5085	5085	1528		2787
Peak-hour factor, PHF	0.94	0.94	0.94	0.94	0.94	0.94
Adj. Flow (vph)	593	3235	1639	54	0	321
RTOR Reduction (vph)	0	0	0	9	0	79
Lane Group Flow (vph)	593	3235	1639	45	0	242
Confl. Peds. (#/hr)				7		7
Turn Type	Prot	NA	NA	Perm		Over
Protected Phases	5	2	6			5
Permitted Phases				6		5
Actuated Green, G (s)	37.7	180.0	132.3	132.3		37.7
Effective Green, g (s)	37.7	180.0	132.3	132.3		37.7
Actuated g/C Ratio	0.21	1.00	0.74	0.74		0.21
Clearance Time (s)	5.0	5.0	5.0	5.0		5.0
Vehicle Extension (s)	3.0	3.0	3.0	3.0		3.0
Lane Grp Cap (vph)	719	5085	3737	1123		583
v/s Ratio Prot	c0.17	c0.64	0.32			0.09
v/s Ratio Perm				0.03		
v/c Ratio	0.82	0.64	0.44	0.04		0.41
Uniform Delay, d1	68.0	0.0	9.3	6.5		61.6
Progression Factor	1.00	1.00	1.00	1.00		1.00
Incremental Delay, d2	7.6	0.3	0.1	0.0		0.5
Delay (s)	75.6	0.3	9.4	6.5		62.1
Level of Service	E	A	A	A		E
Approach Delay (s)		11.9	9.3		62.1	
Approach LOS		B	A		E	

Intersection Summary			
HCM 2000 Control Delay		13.9	HCM 2000 Level of Service B
HCM 2000 Volume to Capacity ratio		0.70	
Actuated Cycle Length (s)		180.0	Sum of lost time (s) 10.0
Intersection Capacity Utilization		71.7%	ICU Level of Service C
Analysis Period (min)		15	

c Critical Lane Group

HCM Unsignalized Intersection Capacity Analysis

8: W Hind Dr & Church Dwy/Shopping Center Dwy

10/8/2014



Movement	EBL	EBT	EBR	WBL	WBT	WBR	NBL	NBT	NBR	SBL	SBT	SBR
Lane Configurations		↔			↔			↑↑			↔	
Volume (veh/h)	0	0	0	83	0	29	0	410	198	9	219	0
Sign Control		Stop			Stop			Free			Free	
Grade		0%			0%			0%			0%	
Peak Hour Factor	0.94	0.94	0.94	0.94	0.94	0.94	0.94	0.94	0.94	0.94	0.94	0.94
Hourly flow rate (vph)	0	0	0	88	0	31	0	436	211	10	233	0
Pedestrians		5										
Lane Width (ft)		12.0										
Walking Speed (ft/s)		4.0										
Percent Blockage		0										
Right turn flare (veh)												
Median type								None			None	
Median storage (veh)												
Upstream signal (ft)								144				
pX, platoon unblocked												
vC, conflicting volume	506	904	121	677	799	323	238			647		
vC1, stage 1 conf vol												
vC2, stage 2 conf vol												
vCu, unblocked vol	506	904	121	677	799	323	238			647		
tC, single (s)	7.5	6.5	6.9	*6.5	6.5	*5.9	4.1			4.1		
tC, 2 stage (s)												
tF (s)	3.5	4.0	3.3	3.5	4.0	3.3	2.2			2.2		
p0 queue free %	100	100	100	78	100	96	100			99		
cM capacity (veh/h)	424	271	903	407	313	738	1321			935		

Direction, Lane #	EB 1	WB 1	NB 1	NB 2	SB 1	SB 2
Volume Total	0	119	291	356	87	155
Volume Left	0	88	0	0	10	0
Volume Right	0	31	0	211	0	0
cSH	1700	461	1700	1700	935	1700
Volume to Capacity	0.00	0.26	0.17	0.21	0.01	0.09
Queue Length 95th (ft)	0	26	0	0	1	0
Control Delay (s)	0.0	15.5	0.0	0.0	1.1	0.0
Lane LOS	A	C			A	
Approach Delay (s)	0.0	15.5	0.0		0.4	
Approach LOS	A	C				

Intersection Summary		
Average Delay		1.9
Intersection Capacity Utilization	30.7%	ICU Level of Service A
Analysis Period (min)		15

* User Entered Value

HCM Signalized Intersection Capacity Analysis

18: Waiupe Cir & Kalaniana'ole Hwy

10/7/2014

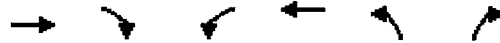

Movement	EBT	EBR	WBL	WBT	NBL	NBR
Lane Configurations	↑↑↑	↑	↔	↑↑↑	↑	↑
Volume (vph)	3583	55	16	1827	24	15
Ideal Flow (vphpl)	1900	1900	1900	1900	1900	1900
Total Lost time (s)	5.0	5.0	5.0	5.0	5.0	5.0
Lane Util. Factor	0.91	1.00	1.00	0.91	1.00	1.00
Frbp, ped/bikes	1.00	0.98	1.00	1.00	1.00	0.99
Flpb, ped/bikes	1.00	1.00	1.00	1.00	1.00	1.00
Frt	1.00	0.85	1.00	1.00	1.00	0.85
Flt Protected	1.00	1.00	0.95	1.00	0.95	1.00
Satd. Flow (prot)	5085	1544	1770	5085	1770	1560
Flt Permitted	1.00	1.00	0.95	1.00	0.95	1.00
Satd. Flow (perm)	5085	1544	1770	5085	1770	1560
Peak-hour factor, PHF	0.94	0.94	0.94	0.94	0.94	0.94
Adj. Flow (vph)	3812	59	17	1944	26	16
RTOR Reduction (vph)	0	5	0	0	0	15
Lane Group Flow (vph)	3812	54	17	1944	26	1
Confl. Peds. (#/hr)		1				1
Turn Type	NA	Perm	Prot	NA	Prot	Perm
Protected Phases	2		1	6	8	
Permitted Phases		2				8
Actuated Green, G (s)	132.7	132.7	4.6	142.3	6.5	6.5
Effective Green, g (s)	132.7	132.7	4.6	142.3	6.5	6.5
Actuated g/C Ratio	0.84	0.84	0.03	0.90	0.04	0.04
Clearance Time (s)	5.0	5.0	5.0	5.0	5.0	5.0
Vehicle Extension (s)	3.0	3.0	3.0	3.0	3.0	3.0
Lane Grp Cap (vph)	4249	1290	51	4556	72	63
v/s Ratio Prot	c0.75		0.01	c0.38	c0.01	
v/s Ratio Perm		0.03				0.00
v/c Ratio	0.90	0.04	0.33	0.43	0.36	0.01
Uniform Delay, d1	8.6	2.2	75.6	1.4	74.1	73.1
Progression Factor	1.00	1.00	1.00	1.00	1.00	1.00
Incremental Delay, d2	2.9	0.0	3.8	0.1	3.1	0.1
Delay (s)	11.4	2.2	79.4	1.5	77.2	73.1
Level of Service	B	A	E	A	E	E
Approach Delay (s)	11.3			2.1	75.7	
Approach LOS	B			A	E	

Intersection Summary

HCM 2000 Control Delay	8.7	HCM 2000 Level of Service	A
HCM 2000 Volume to Capacity ratio	0.87		
Actuated Cycle Length (s)	158.8	Sum of lost time (s)	15.0
Intersection Capacity Utilization	81.2%	ICU Level of Service	D
Analysis Period (min)	15		

c Critical Lane Group

HCM Unsignalized Intersection Capacity Analysis

19: W Hind Dr & Makalena St

11/28/2014



Movement	EBL	EBT	EBR	WBL	WBT	WBR	NBL	NBT	NBR	SBL	SBT	SBR
Lane Configurations					↕			↕			↕	
Volume (veh/h)	0	0	0	5	0	3	23	330	24	0	168	6
Sign Control		Stop			Stop			Free			Free	
Grade		0%			0%			0%			0%	
Peak Hour Factor	0.96	0.96	0.96	0.96	0.96	0.96	0.96	0.96	0.96	0.96	0.96	0.96
Hourly flow rate (vph)	0	0	0	5	0	3	24	344	25	0	175	6
Pedestrians		1			11							
Lane Width (ft)		0.0			12.0							
Walking Speed (ft/s)		4.0			4.0							
Percent Blockage		0			1							
Right turn flare (veh)												
Median type								None			None	
Median storage veh												
Upstream signal (ft)								568				
pX, platoon unblocked												
vC, conflicting volume	402	607	179	593	597	195	182			380		
vC1, stage 1 conf vol												
vC2, stage 2 conf vol												
vCu, unblocked vol	402	607	179	593	597	195	182			380		
tC, single (s)	7.5	6.5	6.9	*6.5	6.5	*5.9	4.1			4.1		
tC, 2 stage (s)												
tF (s)	3.5	4.0	3.3	3.5	4.0	3.3	2.2			2.2		
p0 queue free %	100	100	100	99	100	100	98			100		
cM capacity (veh/h)	520	399	833	448	404	852	1390			1165		

Direction, Lane #	WB 1	NB 1	NB 2	SB 1
Volume Total	8	196	197	181
Volume Left	5	24	0	0
Volume Right	3	0	25	6
cSH	545	1390	1700	1165
Volume to Capacity	0.02	0.02	0.12	0.00
Queue Length 95th (ft)	1	1	0	0
Control Delay (s)	11.7	1.1	0.0	0.0
Lane LOS	B	A		
Approach Delay (s)	11.7	0.5		0.0
Approach LOS	B			

Intersection Summary			
Average Delay		0.5	
Intersection Capacity Utilization	34.1%	ICU Level of Service	A
Analysis Period (min)	15		

* User Entered Value

HCM Unsignalized Intersection Capacity Analysis
 20: W Hind Dr & School Dwy/Nenue St

10/7/2014



Movement	EBL	EBT	EBR	WBL	WBT	WBR	NBL	NBT	NBR	SBL	SBT	SBR
Lane Configurations		↔			↔			↔			↔	
Volume (veh/h)	21	8	18	3	0	7	25	294	14	9	153	7
Sign Control		Stop			Stop			Free			Free	
Grade		0%			0%			0%			0%	
Peak Hour Factor	0.91	0.91	0.91	0.91	0.91	0.91	0.91	0.91	0.91	0.91	0.91	0.91
Hourly flow rate (vph)	23	9	20	3	0	8	27	323	15	10	168	8
Pedestrians		5										
Lane Width (ft)		12.0										
Walking Speed (ft/s)		4.0										
Percent Blockage		0										
Right turn flare (veh)												
Median type								None			None	
Median storage veh												
Upstream signal (ft)								854				
pX, platoon unblocked												
vC, conflicting volume	590	590	177	602	586	331	181			338		
vC1, stage 1 conf vol												
vC2, stage 2 conf vol												
vCu, unblocked vol	590	590	177	602	586	331	181			338		
tC, single (s)	*6.1	*5.5	*5.2	*6.1	6.5	*5.2	4.1			4.1		
tC, 2 stage (s)												
tF (s)	3.5	4.0	3.3	3.5	4.0	3.3	2.2			2.2		
p0 queue free %	95	98	98	99	100	99	98			99		
cM capacity (veh/h)	477	481	907	460	409	781	1389			1221		

Direction, Lane #	EB 1	WB 1	NB 1	SB 1
Volume Total	52	11	366	186
Volume Left	23	3	27	10
Volume Right	20	8	15	8
cSH	583	645	1389	1221
Volume to Capacity	0.09	0.02	0.02	0.01
Queue Length 95th (ft)	7	1	2	1
Control Delay (s)	11.8	10.7	0.7	0.5
Lane LOS	B	B	A	A
Approach Delay (s)	11.8	10.7	0.7	0.5
Approach LOS	B	B		

Intersection Summary			
Average Delay		1.8	
Intersection Capacity Utilization	35.6%	ICU Level of Service	A
Analysis Period (min)		15	

* User Entered Value

APPENDIX D

**CAPACITY ANALYSIS CALCULATIONS
PROJECTED YEAR 2015 PEAK HOUR TRAFFIC
ANALYSIS WITHOUT PROJECT**

HCM Signalized Intersection Capacity Analysis

4: Church Dwy/Nenu St & Kalaniana'ole Hwy

10/7/2014



Movement	EBL	EBT	EBR	WBL	WBT	WBR	NBL	NBT	NBR	SBL	SBT	SBR
Lane Configurations		↑↑			↑↑↑			↕			↕	↗
Volume (vph)	0	998	18	0	4380	145	0	4	1	76	2	54
Ideal Flow (vphpl)	1900	1900	1900	1900	1900	1900	1900	1900	1900	1900	1900	1900
Total Lost time (s)		5.0			5.0			5.0			5.0	5.0
Lane Util. Factor		0.95			0.86			1.00			1.00	1.00
Frb, ped/bikes		1.00			1.00			1.00			1.00	0.93
Flpb, ped/bikes		1.00			1.00			1.00			1.00	1.00
Frt		1.00			1.00			0.97			1.00	0.85
Flt Protected		1.00			1.00			1.00			0.95	1.00
Satd. Flow (prot)		3530			6377			1812			1776	1476
Flt Permitted		1.00			1.00			1.00			0.73	1.00
Satd. Flow (perm)		3530			6377			1812			1357	1476
Peak-hour factor, PHF	0.96	0.96	0.96	0.96	0.96	0.96	0.96	0.96	0.96	0.96	0.96	0.96
Adj. Flow (vph)	0	1040	19	0	4562	151	0	4	1	79	2	56
RTOR Reduction (vph)	0	0	0	0	2	0	0	1	0	0	0	8
Lane Group Flow (vph)	0	1059	0	0	4711	0	0	4	0	0	81	48
Confl. Peds. (#/hr)												13
Turn Type		NA			NA			NA		Perm	NA	Perm
Protected Phases		2			6			8			4	
Permitted Phases							8			4		4
Actuated Green, G (s)		206.1			206.1			18.6			18.6	18.6
Effective Green, g (s)		206.1			206.1			18.6			18.6	18.6
Actuated g/C Ratio		0.88			0.88			0.08			0.08	0.08
Clearance Time (s)		5.0			5.0			5.0			5.0	5.0
Vehicle Extension (s)		3.0			3.0			3.0			3.0	3.0
Lane Grp Cap (vph)		3099			5599			143			107	116
v/s Ratio Prot		0.30			c0.74			0.00				
v/s Ratio Perm											c0.06	0.03
v/c Ratio		0.34			0.84			0.03			0.76	0.41
Uniform Delay, d1		2.5			6.7			99.7			105.8	102.8
Progression Factor		1.00			1.00			1.00			1.00	1.00
Incremental Delay, d2		0.1			1.2			0.1			25.9	2.4
Delay (s)		2.6			7.9			99.8			131.7	105.2
Level of Service		A			A			F			F	F
Approach Delay (s)		2.6			7.9			99.8			120.9	
Approach LOS		A			A			F			F	

Intersection Summary			
HCM 2000 Control Delay	9.7	HCM 2000 Level of Service	A
HCM 2000 Volume to Capacity ratio	0.83		
Actuated Cycle Length (s)	234.7	Sum of lost time (s)	10.0
Intersection Capacity Utilization	89.4%	ICU Level of Service	E
Analysis Period (min)	15		

c Critical Lane Group

HCM Unsignalized Intersection Capacity Analysis

5: W Hind Dr & School Exit/Shopping Center Dwy

10/7/2014



Movement	EBL	EBT	EBR	WBL	WBT	WBR	NBL	NBT	NBR	SBL	SBT	SBR
Lane Configurations		↔			↔			↑↔			↔↑	
Volume (veh/h)	8	7	17	63	0	37	0	170	10	42	318	0
Sign Control		Stop			Stop			Free			Free	
Grade		0%			0%			0%			0%	
Peak Hour Factor	0.87	0.87	0.87	0.87	0.87	0.87	0.87	0.87	0.87	0.87	0.87	0.87
Hourly flow rate (vph)	9	8	20	72	0	43	0	195	11	48	366	0
Pedestrians											11	
Lane Width (ft)											12.0	
Walking Speed (ft/s)											4.0	
Percent Blockage											1	
Right turn flare (veh)												
Median type								None			None	
Median storage veh												
Upstream signal (ft)								274				
pX, platoon unblocked												
vC, conflicting volume	613	669	183	504	663	114	366			207		
vC1, stage 1 conf vol												
vC2, stage 2 conf vol												
vCu, unblocked vol	613	669	183	504	663	114	366			207		
tC, single (s)	*6.5	*5.5	*5.9	*6.5	6.5	*5.9	4.1			4.1		
tC, 2 stage (s)												
tF (s)	3.5	4.0	3.3	3.5	4.0	3.3	2.2			2.2		
p0 queue free %	98	98	98	85	100	95	100			96		
cM capacity (veh/h)	414	441	873	489	367	938	1190			1362		

Direction, Lane #	EB 1	WB 1	NB 1	NB 2	SB 1	SB 2
Volume Total	37	115	130	77	170	244
Volume Left	9	72	0	0	48	0
Volume Right	20	43	0	11	0	0
cSH	585	594	1700	1700	1362	1700
Volume to Capacity	0.06	0.19	0.08	0.05	0.04	0.14
Queue Length 95th (ft)	5	18	0	0	3	0
Control Delay (s)	11.6	12.5	0.0	0.0	2.4	0.0
Lane LOS	B	B			A	
Approach Delay (s)	11.6	12.5	0.0		1.0	
Approach LOS	B	B				

Intersection Summary		
Average Delay		2.9
Intersection Capacity Utilization	38.0%	ICU Level of Service
Analysis Period (min)		15
		A

* User Entered Value

HCM Signalized Intersection Capacity Analysis
 6: Kalaniana'ole Hwy & W Hind Dr

10/7/2014



Movement	EBL	EBT	WBT	WBR	SBL	SBR
Lane Configurations	↖↗	↑↑	↑↑↑↑	↖		↖↗
Volume (vph)	199	1010	4363	71	0	431
Ideal Flow (vphpl)	1900	1900	1900	1900	1900	1900
Total Lost time (s)	5.0	5.0	5.0	5.0		5.0
Lane Util. Factor	0.97	0.95	0.86	1.00		0.88
Frbp, ped/bikes	1.00	1.00	1.00	0.98		1.00
Flpb, ped/bikes	1.00	1.00	1.00	1.00		1.00
Frt	1.00	1.00	1.00	0.85		0.85
Flt Protected	0.95	1.00	1.00	1.00		1.00
Satd. Flow (prot)	3433	3539	6408	1558		2787
Flt Permitted	0.95	1.00	1.00	1.00		1.00
Satd. Flow (perm)	3433	3539	6408	1558		2787
Peak-hour factor, PHF	0.95	0.95	0.95	0.95	0.95	0.95
Adj. Flow (vph)	209	1063	4593	75	0	454
RTOR Reduction (vph)	0	0	0	4	0	84
Lane Group Flow (vph)	209	1063	4593	71	0	370
Confl. Peds. (#/hr)				1		1
Turn Type	Prot	NA	NA	Perm		Over
Protected Phases	5	2	6			5
Permitted Phases				6		5
Actuated Green, G (s)	33.1	210.3	167.2	167.2		33.1
Effective Green, g (s)	33.1	210.3	167.2	167.2		33.1
Actuated g/C Ratio	0.16	1.00	0.80	0.80		0.16
Clearance Time (s)	5.0	5.0	5.0	5.0		5.0
Vehicle Extension (s)	3.0	3.0	3.0	3.0		3.0
Lane Grp Cap (vph)	540	3539	5094	1238		438
v/s Ratio Prot	0.06	0.30	c0.72			c0.13
v/s Ratio Perm				0.05		
v/c Ratio	0.39	0.30	0.90	0.06		0.84
Uniform Delay, d1	79.5	0.0	15.6	4.6		86.1
Progression Factor	1.00	1.00	1.00	1.00		1.00
Incremental Delay, d2	0.5	0.0	2.6	0.0		13.8
Delay (s)	80.0	0.0	18.2	4.6		99.9
Level of Service	E	A	B	A		F
Approach Delay (s)		13.2	18.0		99.9	
Approach LOS		B	B		F	

Intersection Summary			
HCM 2000 Control Delay	22.8	HCM 2000 Level of Service	C
HCM 2000 Volume to Capacity ratio	0.89		
Actuated Cycle Length (s)	210.3	Sum of lost time (s)	10.0
Intersection Capacity Utilization	86.7%	ICU Level of Service	E
Analysis Period (min)	15		

c Critical Lane Group

HCM Unsignalized Intersection Capacity Analysis

8: W Hind Dr & Church Dwy/Shopping Center Dwy

10/8/2014



Movement	EBL	EBT	EBR	WBL	WBT	WBR	NBL	NBT	NBR	SBL	SBT	SBR
Lane Configurations		↔			↔			↑↑			↑↑	
Volume (veh/h)	0	0	0	40	0	18	0	163	107	6	391	0
Sign Control		Stop			Stop			Free			Free	
Grade		0%			0%			0%			0%	
Peak Hour Factor	0.93	0.93	0.93	0.93	0.93	0.93	0.93	0.93	0.93	0.93	0.93	0.93
Hourly flow rate (vph)	0	0	0	43	0	19	0	175	115	6	420	0
Pedestrians		4										
Lane Width (ft)		12.0										
Walking Speed (ft/s)		4.0										
Percent Blockage		0										
Right turn flare (veh)												
Median type								None			None	
Median storage (veh)												
Upstream signal (ft)								144				
pX, platoon unblocked												
vC, conflicting volume	544	728	214	456	670	145	424			290		
vC1, stage 1 conf vol												
vC2, stage 2 conf vol												
vCu, unblocked vol	544	728	214	456	670	145	424			290		
tC, single (s)	7.5	6.5	6.9	*6.5	6.5	*5.9	4.1			4.1		
tC, 2 stage (s)												
tF (s)	3.5	4.0	3.3	3.5	4.0	3.3	2.2			2.2		
p0 queue free %	100	100	100	92	100	98	100			99		
cM capacity (veh/h)	409	346	788	553	373	913	1128			1268		

Direction, Lane #	EB 1	WB 1	NB 1	NB 2	SB 1	SB 2
Volume Total	0	62	117	173	147	280
Volume Left	0	43	0	0	6	0
Volume Right	0	19	0	115	0	0
cSH	1700	630	1700	1700	1268	1700
Volume to Capacity	0.00	0.10	0.07	0.10	0.01	0.16
Queue Length 95th (ft)	0	8	0	0	0	0
Control Delay (s)	0.0	11.3	0.0	0.0	0.4	0.0
Lane LOS	A	B			A	
Approach Delay (s)	0.0	11.3	0.0		0.1	
Approach LOS	A	B				

Intersection Summary		
Average Delay		1.0
Intersection Capacity Utilization	25.1%	ICU Level of Service A
Analysis Period (min)		15

* User Entered Value

HCM Signalized Intersection Capacity Analysis
 18: Wailupe Cir & Kalaniana'ole Hwy

10/8/2014



Movement	EBT	EBR	WBL	WBT	NBL	NBR
Lane Configurations	↑↑	↗	↘	↑↑↑	↖	↗
Volume (vph)	1201	15	9	4785	56	8
Ideal Flow (vphpl)	1900	1900	1900	1900	1900	1900
Total Lost time (s)	5.0	5.0	5.0	5.0	5.0	5.0
Lane Util. Factor	0.95	1.00	1.00	0.86	1.00	1.00
Frpb, ped/bikes	1.00	0.97	1.00	1.00	1.00	1.00
Flpb, ped/bikes	1.00	1.00	1.00	1.00	1.00	1.00
Frt	1.00	0.85	1.00	1.00	1.00	0.85
Flt Protected	1.00	1.00	0.95	1.00	0.95	1.00
Satd. Flow (prot)	3539	1528	1770	6408	1770	1583
Flt Permitted	1.00	1.00	0.95	1.00	0.95	1.00
Satd. Flow (perm)	3539	1528	1770	6408	1770	1583
Peak-hour factor, PHF	0.94	0.94	0.94	0.94	0.94	0.94
Adj. Flow (vph)	1278	16	10	5090	60	9
RTOR Reduction (vph)	0	2	0	0	0	9
Lane Group Flow (vph)	1278	14	10	5090	60	0
Confl. Peds. (#/hr)		2				
Turn Type	NA	Perm	Prot	NA	Prot	Perm
Protected Phases	2		1	6	8	
Permitted Phases		2				8
Actuated Green, G (s)	208.8	208.8	3.3	217.1	12.9	12.9
Effective Green, g (s)	208.8	208.8	3.3	217.1	12.9	12.9
Actuated g/C Ratio	0.87	0.87	0.01	0.90	0.05	0.05
Clearance Time (s)	5.0	5.0	5.0	5.0	5.0	5.0
Vehicle Extension (s)	3.0	3.0	3.0	3.0	3.0	3.0
Lane Grp Cap (vph)	3078	1329	24	5796	95	85
v/s Ratio Prot	0.36		0.01	c0.79	c0.03	
v/s Ratio Perm		0.01				0.00
v/c Ratio	0.42	0.01	0.42	0.88	0.63	0.01
Uniform Delay, d1	3.2	2.0	117.4	5.3	111.2	107.5
Progression Factor	1.00	1.00	1.00	1.00	1.00	1.00
Incremental Delay, d2	0.1	0.0	11.3	1.7	12.9	0.0
Delay (s)	3.3	2.0	128.7	7.0	124.1	107.5
Level of Service	A	A	F	A	F	F
Approach Delay (s)	3.3			7.3	122.0	
Approach LOS	A			A	F	

Intersection Summary			
HCM 2000 Control Delay	7.7	HCM 2000 Level of Service	A
HCM 2000 Volume to Capacity ratio	0.88		
Actuated Cycle Length (s)	240.0	Sum of lost time (s)	15.0
Intersection Capacity Utilization	81.0%	ICU Level of Service	D
Analysis Period (min)	15		

c Critical Lane Group

HCM Unsignalized Intersection Capacity Analysis
 19: W Hind Drive & Makalena St

11/28/2014



Movement	EBL	EBT	EBR	WBL	WBT	WBR	NBL	NBT	NBR	SBL	SBT	SBR
Lane Configurations					↕			↕			↕	
Volume (veh/h)	0	0	0	5	0	3	59	145	7	0	356	11
Sign Control		Stop			Stop			Free			Free	
Grade		0%			0%			0%			0%	
Peak Hour Factor	0.89	0.89	0.89	0.89	0.89	0.89	0.89	0.89	0.89	0.89	0.89	0.89
Hourly flow rate (vph)	0	0	0	6	0	3	66	163	8	0	400	12
Pedestrians		6			18						2	
Lane Width (ft)		0.0			12.0						12.0	
Walking Speed (ft/s)		4.0			4.0						4.0	
Percent Blockage		0			1						0	
Right turn flare (veh)												
Median type								None			None	
Median storage (veh)												
Upstream signal (ft)								568				
pX, platoon unblocked												
vC, conflicting volume	632	734	412	724	736	105	418			189		
vC1, stage 1 conf vol												
vC2, stage 2 conf vol												
vCu, unblocked vol	632	734	412	724	736	105	418			189		
tC, single (s)	7.5	6.5	6.9	*6.5	6.5	*5.9	4.1			4.1		
tC, 2 stage (s)												
tF (s)	3.5	4.0	3.3	3.5	4.0	3.3	2.2			2.2		
p0 queue free %	100	100	100	98	100	100	94			100		
cM capacity (veh/h)	343	321	589	359	320	941	1137			1362		

Direction, Lane #	WB 1	NB 1	NB 2	SB 1
Volume Total	9	148	89	412
Volume Left	6	66	0	0
Volume Right	3	0	8	12
cSH	468	1137	1700	1362
Volume to Capacity	0.02	0.06	0.05	0.00
Queue Length 95th (ft)	1	5	0	0
Control Delay (s)	12.8	4.0	0.0	0.0
Lane LOS	B	A		
Approach Delay (s)	12.8	2.5		0.0
Approach LOS	B			

Intersection Summary			
Average Delay		1.1	
Intersection Capacity Utilization	42.7%		ICU Level of Service A
Analysis Period (min)		15	

* User Entered Value

HCM Unsignalized Intersection Capacity Analysis
 20: W Hind Drive & School Dwy/Nenu St

10/7/2014



Movement	EBL	EBT	EBR	WBL	WBT	WBR	NBL	NBT	NBR	SBL	SBT	SBR
Lane Configurations		↔			↔			↔			↔	
Volume (veh/h)	5	2	23	8	3	3	33	100	15	11	336	14
Sign Control		Stop			Stop			Free			Free	
Grade		0%			0%			0%			0%	
Peak Hour Factor	0.93	0.93	0.93	0.93	0.93	0.93	0.93	0.93	0.93	0.93	0.93	0.93
Hourly flow rate (vph)	5	2	25	9	3	3	35	108	16	12	361	15
Pedestrians		3										
Lane Width (ft)		12.0										
Walking Speed (ft/s)		4.0										
Percent Blockage		0										
Right turn flare (veh)												
Median type								None			None	
Median storage veh												
Upstream signal (ft)								854				
pX, platoon unblocked												
vC, conflicting volume	587	590	372	605	590	116	379			124		
vC1, stage 1 conf vol												
vC2, stage 2 conf vol												
vCu, unblocked vol	587	590	372	605	590	116	379			124		
tC, single (s)	*6.1	*5.5	*5.2	*6.1	*5.5	*5.2	4.1			4.1		
tC, 2 stage (s)												
tF (s)	3.5	4.0	3.3	3.5	4.0	3.3	2.2			2.2		
p0 queue free %	99	100	97	98	99	100	97			99		
cM capacity (veh/h)	477	476	747	454	477	968	1176			1463		

Direction, Lane #	EB 1	WB 1	NB 1	SB 1
Volume Total	32	15	159	388
Volume Left	5	9	35	12
Volume Right	25	3	16	15
cSH	660	518	1176	1463
Volume to Capacity	0.05	0.03	0.03	0.01
Queue Length 95th (ft)	4	2	2	1
Control Delay (s)	10.7	12.2	2.0	0.3
Lane LOS	B	B	A	A
Approach Delay (s)	10.7	12.2	2.0	0.3
Approach LOS	B	B		

Intersection Summary			
Average Delay		1.6	
Intersection Capacity Utilization	32.8%	ICU Level of Service	A
Analysis Period (min)	15		

* User Entered Value

HCM Signalized Intersection Capacity Analysis

4: Church Dwy/Nenuue St & Kalaniana'ole Hwy

10/7/2014

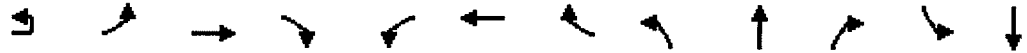

Movement	EBU	EBL	EBT	EBR	WBL	WBT	WBR	NBL	NBT	NBR	SBL	SBT
Lane Configurations		↔	↑↑↑		↔	↑↑↑			↕			↔
Volume (vph)	7	11	3092	2	7	1587	97	0	0	0	210	1
Ideal Flow (vphpl)	1900	1900	1900	1900	1900	1900	1900	1900	1900	1900	1900	1900
Total Lost time (s)		5.0	5.0		5.0	5.0						5.0
Lane Util. Factor		1.00	0.91		1.00	0.91						1.00
Frbp, ped/bikes		1.00	1.00		1.00	1.00						1.00
Flpb, ped/bikes		1.00	1.00		1.00	1.00						1.00
Frt		1.00	1.00		1.00	0.99						1.00
Flt Protected		0.95	1.00		0.95	1.00						0.95
Satd. Flow (prot)		1770	5085		1770	5032						1774
Flt Permitted		0.95	1.00		0.95	1.00						0.73
Satd. Flow (perm)		1770	5085		1770	5032						1355
Peak-hour factor, PHF	0.95	0.95	0.95	0.95	0.95	0.95	0.95	0.95	0.95	0.95	0.95	0.95
Adj. Flow (vph)	7	12	3255	2	7	1671	102	0	0	0	221	1
RTOR Reduction (vph)	0	0	0	0	0	3	0	0	0	0	0	0
Lane Group Flow (vph)	0	19	3257	0	7	1770	0	0	0	0	0	222
Confl. Peds. (#/hr)							3					
Turn Type	Prot	Prot	NA		Prot	NA					Perm	NA
Protected Phases	5	5	2		1	6			8			4
Permitted Phases								8			4	
Actuated Green, G (s)		3.1	87.0		1.3	85.2						26.3
Effective Green, g (s)		3.1	87.0		1.3	85.2						26.3
Actuated g/C Ratio		0.02	0.67		0.01	0.66						0.20
Clearance Time (s)		5.0	5.0		5.0	5.0						5.0
Vehicle Extension (s)		3.0	3.0		3.0	3.0						3.0
Lane Grp Cap (vph)		42	3413		17	3308						274
v/s Ratio Prot		c0.01	c0.64		0.00	0.35						
v/s Ratio Perm												c0.16
v/c Ratio		0.45	0.95		0.41	0.54						0.81
Uniform Delay, d1		62.4	19.5		63.8	11.7						49.3
Progression Factor		1.00	1.00		1.00	1.00						1.00
Incremental Delay, d2		7.6	7.4		15.4	0.2						16.4
Delay (s)		70.0	26.9		79.2	11.9						65.6
Level of Service		E	C		E	B						E
Approach Delay (s)			27.2			12.2			0.0			62.5
Approach LOS			C			B			A			E

Intersection Summary			
HCM 2000 Control Delay	23.8	HCM 2000 Level of Service	C
HCM 2000 Volume to Capacity ratio	0.92		
Actuated Cycle Length (s)	129.6	Sum of lost time (s)	15.0
Intersection Capacity Utilization	80.1%	ICU Level of Service	D
Analysis Period (min)	15		

c Critical Lane Group

HCM Signalized Intersection Capacity Analysis
 4: Church Dwy/Nenu St & Kalaniana'ole Hwy

10/7/2014



Movement	SBR
Lane Configurations	T
Volume (vph)	31
Ideal Flow (vphpl)	1900
Total Lost time (s)	5.0
Lane Util. Factor	1.00
Frbp, ped/bikes	0.98
Flpb, ped/bikes	1.00
Frt	0.85
Flt Protected	1.00
Satd. Flow (prot)	1545
Flt Permitted	1.00
Satd. Flow (perm)	1545
Peak-hour factor, PHF	0.95
Adj. Flow (vph)	33
RTOR Reduction (vph)	26
Lane Group Flow (vph)	7
Confl. Peds. (#/hr)	5
Turn Type	Perm
Protected Phases	
Permitted Phases	4
Actuated Green, G (s)	26.3
Effective Green, g (s)	26.3
Actuated g/C Ratio	0.20
Clearance Time (s)	5.0
Vehicle Extension (s)	3.0
Lane Grp Cap (vph)	313
v/s Ratio Prot	
v/s Ratio Perm	0.00
v/c Ratio	0.02
Uniform Delay, d1	41.3
Progression Factor	1.00
Incremental Delay, d2	0.0
Delay (s)	41.4
Level of Service	D
Approach Delay (s)	
Approach LOS	
Intersection Summary	

HCM Unsignalized Intersection Capacity Analysis

5: W Hind Dr & School Exit/Shopping Center Dwy

10/7/2014



Movement	EBL	EBT	EBR	WBL	WBT	WBR	NBL	NBT	NBR	SBL	SBT	SBR
Lane Configurations		↔			↔			↑↓			↑↓	
Volume (veh/h)	10	7	23	67	0	53	0	315	124	34	138	0
Sign Control		Stop			Stop			Free			Free	
Grade		0%			0%			0%			0%	
Peak Hour Factor	0.94	0.94	0.94	0.94	0.94	0.94	0.94	0.94	0.94	0.94	0.94	0.94
Hourly flow rate (vph)	11	7	24	71	0	56	0	335	132	36	147	0
Pedestrians												16
Lane Width (ft)												12.0
Walking Speed (ft/s)												4.0
Percent Blockage												1
Right turn flare (veh)												
Median type								None			None	
Median storage (veh)												
Upstream signal (ft)								274				
pX, platoon unblocked												
vC, conflicting volume	459	686	73	575	620	250	147			467		
vC1, stage 1 conf vol												
vC2, stage 2 conf vol												
vCu, unblocked vol	459	686	73	575	620	250	147			467		
tC, single (s)	*6.5	*5.5	*5.9	*6.5	6.5	*5.9	4.1			4.1		
tC, 2 stage (s)												
tF (s)	3.5	4.0	3.3	3.5	4.0	3.3	2.2			2.2		
p0 queue free %	98	98	98	84	100	93	100			97		
cM capacity (veh/h)	495	434	994	444	389	796	1433			1091		

Direction, Lane #	EB 1	WB 1	NB 1	NB 2	SB 1	SB 2
Volume Total	43	128	223	244	85	98
Volume Left	11	71	0	0	36	0
Volume Right	24	56	0	132	0	0
cSH	673	552	1700	1700	1091	1700
Volume to Capacity	0.06	0.23	0.13	0.14	0.03	0.06
Queue Length 95th (ft)	5	22	0	0	3	0
Control Delay (s)	10.7	13.5	0.0	0.0	3.7	0.0
Lane LOS	B	B			A	
Approach Delay (s)	10.7	13.5	0.0		1.7	
Approach LOS	B	B				

Intersection Summary		
Average Delay		3.0
Intersection Capacity Utilization	41.8%	ICU Level of Service A
Analysis Period (min)		15

* User Entered Value

HCM Signalized Intersection Capacity Analysis

6: Kalaniana'ole Hwy & W Hind Dr

10/7/2014



Movement	EBL	EBT	WBT	WBR	SBL	SBR
Lane Configurations	↖↖	↑↑↑	↑↑↑	↗		↘↘
Volume (vph)	557	3105	1574	51	0	302
Ideal Flow (vphpl)	1900	1900	1900	1900	1900	1900
Total Lost time (s)	5.0	5.0	5.0	5.0		5.0
Lane Util. Factor	0.97	0.91	0.91	1.00		0.88
Frbp, ped/bikes	1.00	1.00	1.00	0.96		1.00
Flpb, ped/bikes	1.00	1.00	1.00	1.00		1.00
Frt	1.00	1.00	1.00	0.85		0.85
Flt Protected	0.95	1.00	1.00	1.00		1.00
Satd. Flow (prot)	3433	5085	5085	1528		2787
Flt Permitted	0.95	1.00	1.00	1.00		1.00
Satd. Flow (perm)	3433	5085	5085	1528		2787
Peak-hour factor, PHF	0.94	0.94	0.94	0.94	0.94	0.94
Adj. Flow (vph)	593	3303	1674	54	0	321
RTOR Reduction (vph)	0	0	0	9	0	79
Lane Group Flow (vph)	593	3303	1674	45	0	242
Confl. Peds. (#/hr)				7		7
Turn Type	Prot	NA	NA	Perm		Over
Protected Phases	5	2	6			5
Permitted Phases				6		5
Actuated Green, G (s)	37.7	180.0	132.3	132.3		37.7
Effective Green, g (s)	37.7	180.0	132.3	132.3		37.7
Actuated g/C Ratio	0.21	1.00	0.74	0.74		0.21
Clearance Time (s)	5.0	5.0	5.0	5.0		5.0
Vehicle Extension (s)	3.0	3.0	3.0	3.0		3.0
Lane Grp Cap (vph)	719	5085	3737	1123		583
v/s Ratio Prot	c0.17	c0.65	0.33			0.09
v/s Ratio Perm				0.03		
v/c Ratio	0.82	0.65	0.45	0.04		0.41
Uniform Delay, d1	68.0	0.0	9.4	6.5		61.6
Progression Factor	1.00	1.00	1.00	1.00		1.00
Incremental Delay, d2	7.6	0.3	0.1	0.0		0.5
Delay (s)	75.6	0.3	9.5	6.5		62.1
Level of Service	E	A	A	A		E
Approach Delay (s)		11.8	9.4		62.1	
Approach LOS		B	A		E	

Intersection Summary			
HCM 2000 Control Delay	13.8	HCM 2000 Level of Service	B
HCM 2000 Volume to Capacity ratio	0.71		
Actuated Cycle Length (s)	180.0	Sum of lost time (s)	10.0
Intersection Capacity Utilization	72.9%	ICU Level of Service	C
Analysis Period (min)	15		

c Critical Lane Group

HCM Unsignalized Intersection Capacity Analysis

8: W Hind Dr & Church Dwy/Shopping Center Dwy

10/8/2014



Movement	EBL	EBT	EBR	WBL	WBT	WBR	NBL	NBT	NBR	SBL	SBT	SBR
Lane Configurations		↔			↔			↕			↕	
Volume (veh/h)	0	0	0	83	0	29	0	410	198	9	219	0
Sign Control		Stop			Stop			Free			Free	
Grade		0%			0%			0%			0%	
Peak Hour Factor	0.94	0.94	0.94	0.94	0.94	0.94	0.94	0.94	0.94	0.94	0.94	0.94
Hourly flow rate (vph)	0	0	0	88	0	31	0	436	211	10	233	0
Pedestrians		5										
Lane Width (ft)		12.0										
Walking Speed (ft/s)		4.0										
Percent Blockage		0										
Right turn flare (veh)												
Median type								None			None	
Median storage (veh)												
Upstream signal (ft)								144				
pX, platoon unblocked												
vC, conflicting volume	506	904	121	677	799	323	238			647		
vC1, stage 1 conf vol												
vC2, stage 2 conf vol												
vCu, unblocked vol	506	904	121	677	799	323	238			647		
tC, single (s)	7.5	6.5	6.9	*6.5	6.5	*5.9	4.1			4.1		
tC, 2 stage (s)												
tF (s)	3.5	4.0	3.3	3.5	4.0	3.3	2.2			2.2		
p0 queue free %	100	100	100	78	100	96	100			99		
cM capacity (veh/h)	424	271	903	407	313	738	1321			935		

Direction, Lane #	EB 1	WB 1	NB 1	NB 2	SB 1	SB 2
Volume Total	0	119	291	356	87	155
Volume Left	0	88	0	0	10	0
Volume Right	0	31	0	211	0	0
cSH	1700	461	1700	1700	935	1700
Volume to Capacity	0.00	0.26	0.17	0.21	0.01	0.09
Queue Length 95th (ft)	0	26	0	0	1	0
Control Delay (s)	0.0	15.5	0.0	0.0	1.1	0.0
Lane LOS	A	C			A	
Approach Delay (s)	0.0	15.5	0.0		0.4	
Approach LOS	A	C				

Intersection Summary		
Average Delay		1.9
Intersection Capacity Utilization	30.7%	ICU Level of Service A
Analysis Period (min)		15

* User Entered Value

HCM Signalized Intersection Capacity Analysis

18: Waiupe Cir & Kaliaoaole Hwy

10/7/2014



Movement	EBT	EBR	WBL	WBT	NBL	NBR
Lane Configurations	↑↑↑	↗	↘	↑↑↑	↗	↗
Volume (vph)	3647	55	16	1860	24	15
Ideal Flow (vphpl)	1900	1900	1900	1900	1900	1900
Total Lost time (s)	5.0	5.0	5.0	5.0	5.0	5.0
Lane Util. Factor	0.91	1.00	1.00	0.91	1.00	1.00
Frbp, ped/bikes	1.00	0.98	1.00	1.00	1.00	0.99
Flpb, ped/bikes	1.00	1.00	1.00	1.00	1.00	1.00
Frt	1.00	0.85	1.00	1.00	1.00	0.85
Flt Protected	1.00	1.00	0.95	1.00	0.95	1.00
Satd. Flow (prot)	5085	1544	1770	5085	1770	1560
Flt Permitted	1.00	1.00	0.95	1.00	0.95	1.00
Satd. Flow (perm)	5085	1544	1770	5085	1770	1560
Peak-hour factor, PHF	0.94	0.94	0.94	0.94	0.94	0.94
Adj. Flow (vph)	3880	59	17	1979	26	16
RTOR Reduction (vph)	0	5	0	0	0	15
Lane Group Flow (vph)	3880	54	17	1979	26	1
Confl. Peds. (#/hr)		1				1
Turn Type	NA	Perm	Prot	NA	Prot	Perm
Protected Phases	2		1	6	8	
Permitted Phases		2				8
Actuated Green, G (s)	132.7	132.7	4.6	142.3	6.5	6.5
Effective Green, g (s)	132.7	132.7	4.6	142.3	6.5	6.5
Actuated g/C Ratio	0.84	0.84	0.03	0.90	0.04	0.04
Clearance Time (s)	5.0	5.0	5.0	5.0	5.0	5.0
Vehicle Extension (s)	3.0	3.0	3.0	3.0	3.0	3.0
Lane Grp Cap (vph)	4249	1290	51	4556	72	63
v/s Ratio Prot	c0.76		0.01	c0.39	c0.01	
v/s Ratio Perm		0.03				0.00
v/c Ratio	0.91	0.04	0.33	0.43	0.36	0.01
Uniform Delay, d1	9.1	2.2	75.6	1.4	74.1	73.1
Progression Factor	1.00	1.00	1.00	1.00	1.00	1.00
Incremental Delay, d2	3.5	0.0	3.8	0.1	3.1	0.1
Delay (s)	12.6	2.2	79.4	1.5	77.2	73.1
Level of Service	B	A	E	A	E	E
Approach Delay (s)	12.4			2.1	75.7	
Approach LOS	B			A	E	

Intersection Summary			
HCM 2000 Control Delay	9.4	HCM 2000 Level of Service	A
HCM 2000 Volume to Capacity ratio	0.88		
Actuated Cycle Length (s)	158.8	Sum of lost time (s)	15.0
Intersection Capacity Utilization	82.5%	ICU Level of Service	E
Analysis Period (min)	15		

c Critical Lane Group

HCM Unsignalized Intersection Capacity Analysis

19: W Hind Dr & Makalena St

11/28/2014



Movement	EBL	EBT	EBR	WBL	WBT	WBR	NBL	NBT	NBR	SBL	SBT	SBR
Lane Configurations					↕			↕			↕	
Volume (veh/h)	0	0	0	5	0	3	23	330	24	0	168	6
Sign Control		Stop			Stop			Free			Free	
Grade		0%			0%			0%			0%	
Peak Hour Factor	0.96	0.96	0.96	0.96	0.96	0.96	0.96	0.96	0.96	0.96	0.96	0.96
Hourly flow rate (vph)	0	0	0	5	0	3	24	344	25	0	175	6
Pedestrians		1			11						3	
Lane Width (ft)		0.0			12.0						12.0	
Walking Speed (ft/s)		4.0			4.0						4.0	
Percent Blockage		0			1						0	
Right turn flare (veh)												
Median type								None			None	
Median storage (veh)												
Upstream signal (ft)								568				
pX, platoon unblocked												
vC, conflicting volume	405	607	179	593	597	198	182			380		
vC1, stage 1 conf vol												
vC2, stage 2 conf vol												
vCu, unblocked vol	405	607	179	593	597	198	182			380		
tC, single (s)	7.5	6.5	6.9	*6.5	6.5	*5.9	4.1			4.1		
tC, 2 stage (s)												
tF (s)	3.5	4.0	3.3	3.5	4.0	3.3	2.2			2.2		
p0 queue free %	100	100	100	99	100	100	98			100		
cM capacity (veh/h)	516	399	833	448	404	847	1390			1165		

Direction, Lane #	WB 1	NB 1	NB 2	SB 1
Volume Total	8	196	197	181
Volume Left	5	24	0	0
Volume Right	3	0	25	6
cSH	545	1390	1700	1165
Volume to Capacity	0.02	0.02	0.12	0.00
Queue Length 95th (ft)	1	1	0	0
Control Delay (s)	11.7	1.1	0.0	0.0
Lane LOS	B	A		
Approach Delay (s)	11.7	0.5		0.0
Approach LOS	B			

Intersection Summary			
Average Delay		0.5	
Intersection Capacity Utilization		35.1%	ICU Level of Service A
Analysis Period (min)		15	

* User Entered Value

HCM Unsignalized Intersection Capacity Analysis
 20: W Hind Dr & School Dwy/Nenu St

10/7/2014



Movement	EBL	EBT	EBR	WBL	WBT	WBR	NBL	NBT	NBR	SBL	SBT	SBR
Lane Configurations		↔			↔			↔			↔	
Volume (veh/h)	21	8	18	3	0	7	25	294	14	9	153	7
Sign Control		Stop			Stop			Free			Free	
Grade		0%			0%			0%			0%	
Peak Hour Factor	0.91	0.91	0.91	0.91	0.91	0.91	0.91	0.91	0.91	0.91	0.91	0.91
Hourly flow rate (vph)	23	9	20	3	0	8	27	323	15	10	168	8
Pedestrians		5										
Lane Width (ft)		12.0										
Walking Speed (ft/s)		4.0										
Percent Blockage		0										
Right turn flare (veh)												
Median type								None			None	
Median storage veh												
Upstream signal (ft)								854				
pX, platoon unblocked												
vC, conflicting volume	590	590	177	602	586	331	181			338		
vC1, stage 1 conf vol												
vC2, stage 2 conf vol												
vCu, unblocked vol	590	590	177	602	586	331	181			338		
tC, single (s)	*6.1	*5.5	*5.2	*6.1	6.5	*5.2	4.1			4.1		
tC, 2 stage (s)												
tF (s)	3.5	4.0	3.3	3.5	4.0	3.3	2.2			2.2		
p0 queue free %	95	98	98	99	100	99	98			99		
cM capacity (veh/h)	477	481	907	460	409	781	1389			1221		

Direction, Lane #	EB 1	WB 1	NB 1	SB 1
Volume Total	52	11	366	186
Volume Left	23	3	27	10
Volume Right	20	8	15	8
cSH	583	645	1389	1221
Volume to Capacity	0.09	0.02	0.02	0.01
Queue Length 95th (ft)	7	1	2	1
Control Delay (s)	11.8	10.7	0.7	0.5
Lane LOS	B	B	A	A
Approach Delay (s)	11.8	10.7	0.7	0.5
Approach LOS	B	B		

Intersection Summary			
Average Delay		1.8	
Intersection Capacity Utilization	35.6%	ICU Level of Service	A
Analysis Period (min)	15		

* User Entered Value

APPENDIX E

CAPACITY ANALYSIS CALCULATIONS
PROJECTED YEAR 2015 PEAK HOUR TRAFFIC ANALYSIS
WITH ALTERNATIVE 1

HCM Signalized Intersection Capacity Analysis

4: Church Dwy/Nenu St & Kalaniana'ole Hwy

11/28/2014



Movement	EBL	EBT	EBR	WBL	WBT	WBR	NBL	NBT	NBR	SBL	SBT	SBR
Lane Configurations		↑↑			↑↑↑			↕			↕	↕
Volume (vph)	0	1001	18	0	4418	145	0	4	1	78	2	54
Ideal Flow (vphpl)	1900	1900	1900	1900	1900	1900	1900	1900	1900	1900	1900	1900
Total Lost time (s)		5.0			5.0			5.0			5.0	5.0
Lane Util. Factor		0.95			0.86			1.00			1.00	1.00
Frb, ped/bikes		1.00			1.00			1.00			1.00	0.93
Flpb, ped/bikes		1.00			1.00			1.00			1.00	1.00
Frt		1.00			1.00			0.97			1.00	0.85
Flt Protected		1.00			1.00			1.00			0.95	1.00
Satd. Flow (prot)		3530			6377			1812			1776	1476
Flt Permitted		1.00			1.00			1.00			0.73	1.00
Satd. Flow (perm)		3530			6377			1812			1356	1476
Peak-hour factor, PHF	0.96	0.96	0.96	0.96	0.96	0.96	0.96	0.96	0.96	0.96	0.96	0.96
Adj. Flow (vph)	0	1043	19	0	4602	151	0	4	1	81	2	56
RTOR Reduction (vph)	0	0	0	0	2	0	0	1	0	0	0	8
Lane Group Flow (vph)	0	1062	0	0	4751	0	0	4	0	0	83	48
Confl. Peds. (#/hr)												13
Turn Type		NA			NA			NA		Perm	NA	Perm
Protected Phases		2			6			8			4	
Permitted Phases							8			4		4
Actuated Green, G (s)		205.1			205.1			19.0			19.0	19.0
Effective Green, g (s)		205.1			205.1			19.0			19.0	19.0
Actuated g/C Ratio		0.88			0.88			0.08			0.08	0.08
Clearance Time (s)		5.0			5.0			5.0			5.0	5.0
Vehicle Extension (s)		3.0			3.0			3.0			3.0	3.0
Lane Grp Cap (vph)		3092			5587			147			110	119
v/s Ratio Prot		0.30			c0.75			0.00				
v/s Ratio Perm											c0.06	0.03
v/c Ratio		0.34			0.85			0.03			0.75	0.40
Uniform Delay, d1		2.6			7.0			99.0			105.3	102.1
Progression Factor		1.00			1.00			1.00			1.00	1.00
Incremental Delay, d2		0.1			1.4			0.1			25.0	2.2
Delay (s)		2.6			8.4			99.1			130.3	104.4
Level of Service		A			A			F			F	F
Approach Delay (s)		2.6			8.4			99.1			119.8	
Approach LOS		A			A			F			F	

Intersection Summary

HCM 2000 Control Delay	10.1	HCM 2000 Level of Service	B
HCM 2000 Volume to Capacity ratio	0.84		
Actuated Cycle Length (s)	234.1	Sum of lost time (s)	10.0
Intersection Capacity Utilization	90.0%	ICU Level of Service	E
Analysis Period (min)	15		

c Critical Lane Group

HCM Unsignalized Intersection Capacity Analysis

5: W Hind Dr & School Exit/Shopping Center Dwy

11/28/2014



Movement	EBL	EBT	EBR	WBL	WBT	WBR	NBL	NBT	NBR	SBL	SBT	SBR
Lane Configurations		↔			↔			↑↔			↔↑	
Volume (veh/h)	10	7	17	63	0	37	9	170	10	42	318	0
Sign Control		Stop			Stop			Free			Free	
Grade		0%			0%			0%			0%	
Peak Hour Factor	0.87	0.87	0.87	0.87	0.87	0.87	0.87	0.87	0.87	0.87	0.87	0.87
Hourly flow rate (vph)	11	8	20	72	0	43	10	195	11	48	366	0
Pedestrians											11	
Lane Width (ft)											12.0	
Walking Speed (ft/s)											4.0	
Percent Blockage											1	
Right turn flare (veh)												
Median type								None			None	
Median storage veh												
Upstream signal (ft)								274				
pX, platoon unblocked												
vC, conflicting volume	634	690	183	525	684	114	366			207		
vC1, stage 1 conf vol												
vC2, stage 2 conf vol												
vCu, unblocked vol	634	690	183	525	684	114	366			207		
tC, single (s)	*6.5	*5.5	*5.9	*6.5	6.5	*5.9	4.1			4.1		
tC, 2 stage (s)												
tF (s)	3.5	4.0	3.3	3.5	4.0	3.3	2.2			2.2		
p0 queue free %	97	98	98	85	100	95	99			96		
cM capacity (veh/h)	399	428	873	472	353	938	1190			1362		

Direction, Lane #	EB 1	WB 1	NB 1	NB 2	SB 1	SB 2
Volume Total	39	115	108	109	170	244
Volume Left	11	72	10	0	48	0
Volume Right	20	43	0	11	0	0
cSH	559	579	1190	1700	1362	1700
Volume to Capacity	0.07	0.20	0.01	0.06	0.04	0.14
Queue Length 95th (ft)	6	18	1	0	3	0
Control Delay (s)	11.9	12.8	0.8	0.0	2.4	0.0
Lane LOS	B	B	A		A	
Approach Delay (s)	11.9	12.8	0.4		1.0	
Approach LOS	B	B				

Intersection Summary		
Average Delay		3.1
Intersection Capacity Utilization	37.5%	ICU Level of Service A
Analysis Period (min)		15

* User Entered Value

HCM Signalized Intersection Capacity Analysis

6: Kalaniana'ole Hwy & W Hind Dr

11/28/2014



Movement	EBL	EBT	WBT	WBR	SBL	SBR
Lane Configurations						
Volume (vph)	208	1013	4401	71	0	454
Ideal Flow (vphpl)	1900	1900	1900	1900	1900	1900
Total Lost time (s)	5.0	5.0	5.0	5.0		5.0
Lane Util. Factor	0.97	0.95	0.86	1.00		0.88
Frpb, ped/bikes	1.00	1.00	1.00	0.98		1.00
Flpb, ped/bikes	1.00	1.00	1.00	1.00		1.00
Frt	1.00	1.00	1.00	0.85		0.85
Flt Protected	0.95	1.00	1.00	1.00		1.00
Satd. Flow (prot)	3433	3539	6408	1557		2787
Flt Permitted	0.95	1.00	1.00	1.00		1.00
Satd. Flow (perm)	3433	3539	6408	1557		2787
Peak-hour factor, PHF	0.95	0.95	0.95	0.95	0.95	0.95
Adj. Flow (vph)	219	1066	4633	75	0	478
RTOR Reduction (vph)	0	0	0	5	0	84
Lane Group Flow (vph)	219	1066	4633	70	0	394
Confl. Peds. (#/hr)				1		1
Turn Type	Prot	NA	NA	Perm		Over
Protected Phases	5	2	6			5
Permitted Phases				6		5
Actuated Green, G (s)	36.9	235.0	188.1	188.1		36.9
Effective Green, g (s)	36.9	235.0	188.1	188.1		36.9
Actuated g/C Ratio	0.16	1.00	0.80	0.80		0.16
Clearance Time (s)	5.0	5.0	5.0	5.0		5.0
Vehicle Extension (s)	3.0	3.0	3.0	3.0		3.0
Lane Grp Cap (vph)	539	3539	5129	1246		437
v/s Ratio Prot	0.06	0.30	c0.72			c0.14
v/s Ratio Perm				0.04		
v/c Ratio	0.41	0.30	0.90	0.06		0.90
Uniform Delay, d1	89.2	0.0	16.9	4.9		97.3
Progression Factor	1.00	1.00	1.00	1.00		1.00
Incremental Delay, d2	0.5	0.0	2.6	0.0		21.3
Delay (s)	89.7	0.0	19.5	4.9		118.5
Level of Service	F	A	B	A		F
Approach Delay (s)		15.3	19.3		118.5	
Approach LOS		B	B		F	

Intersection Summary			
HCM 2000 Control Delay	25.8	HCM 2000 Level of Service	C
HCM 2000 Volume to Capacity ratio	0.90		
Actuated Cycle Length (s)	235.0	Sum of lost time (s)	10.0
Intersection Capacity Utilization	88.1%	ICU Level of Service	E
Analysis Period (min)	15		

c Critical Lane Group

HCM Unsignalized Intersection Capacity Analysis

8: W Hind Dr & Church Dwy/Shopping Center Dwy

11/28/2014



Movement	EBL	EBT	EBR	WBL	WBT	WBR	NBL	NBT	NBR	SBL	SBT	SBR
Lane Configurations		↔			↔			↑↑			↔	
Volume (veh/h)	0	0	23	40	0	18	0	172	107	6	391	0
Sign Control		Stop			Stop			Free			Free	
Grade		0%			0%			0%			0%	
Peak Hour Factor	0.93	0.93	0.93	0.93	0.93	0.93	0.93	0.93	0.93	0.93	0.93	0.93
Hourly flow rate (vph)	0	0	25	43	0	19	0	185	115	6	420	0
Pedestrians		4										
Lane Width (ft)		12.0										
Walking Speed (ft/s)		4.0										
Percent Blockage		0										
Right turn flare (veh)												
Median type								None			None	
Median storage veh												
Upstream signal (ft)								144				
pX, platoon unblocked												
vC, conflicting volume	549	737	214	490	680	150	424			300		
vC1, stage 1 conf vol												
vC2, stage 2 conf vol												
vCu, unblocked vol	549	737	214	490	680	150	424			300		
tC, single (s)	7.5	6.5	*5.9	*6.5	6.5	*5.9	4.1			4.1		
tC, 2 stage (s)												
tF (s)	3.5	4.0	3.3	3.5	4.0	3.3	2.2			2.2		
p0 queue free %	100	100	97	92	100	98	100			99		
cM capacity (veh/h)	406	341	838	512	369	908	1128			1258		

Direction, Lane #	EB 1	WB 1	NB 1	NB 2	SB 1	SB 2
Volume Total	25	62	123	177	147	280
Volume Left	0	43	0	0	6	0
Volume Right	25	19	0	115	0	0
cSH	838	592	1700	1700	1258	1700
Volume to Capacity	0.03	0.11	0.07	0.10	0.01	0.16
Queue Length 95th (ft)	2	9	0	0	0	0
Control Delay (s)	9.4	11.8	0.0	0.0	0.4	0.0
Lane LOS	A	B			A	
Approach Delay (s)	9.4	11.8	0.0		0.1	
Approach LOS	A	B				

Intersection Summary		
Average Delay		1.3
Intersection Capacity Utilization	31.7%	ICU Level of Service A
Analysis Period (min)		15

* User Entered Value

HCM Signalized Intersection Capacity Analysis

18: Wailupe Cir & Kalaniana'ole Hwy

11/28/2014



Movement	EBT	EBR	WBU	WBL	WBT	NBL	NBR
Lane Configurations	↑↑	↗		↘	↑↑↑	↘	↗
Volume (vph)	1210	15	3	9	4805	56	8
Ideal Flow (vphpl)	1900	1900	1900	1900	1900	1900	1900
Total Lost time (s)	5.0	5.0		5.0	5.0	5.0	5.0
Lane Util. Factor	0.95	1.00		1.00	0.86	1.00	1.00
Frb, ped/bikes	1.00	0.97		1.00	1.00	1.00	1.00
Flpb, ped/bikes	1.00	1.00		1.00	1.00	1.00	1.00
Frt	1.00	0.85		1.00	1.00	1.00	0.85
Flt Protected	1.00	1.00		0.95	1.00	0.95	1.00
Satd. Flow (prot)	3539	1528		1770	6408	1770	1583
Flt Permitted	1.00	1.00		0.95	1.00	0.95	1.00
Satd. Flow (perm)	3539	1528		1770	6408	1770	1583
Peak-hour factor, PHF	0.94	0.94	0.94	0.94	0.94	0.94	0.94
Adj. Flow (vph)	1287	16	3	10	5112	60	9
RTOR Reduction (vph)	0	2	0	0	0	0	9
Lane Group Flow (vph)	1287	14	0	13	5112	60	0
Confl. Peds. (#/hr)		2					
Turn Type	NA	Perm	Prot	Prot	NA	Prot	Perm
Protected Phases	2		1	1	6	8	
Permitted Phases		2					8
Actuated Green, G (s)	206.1	206.1		4.9	216.0	12.9	12.9
Effective Green, g (s)	206.1	206.1		4.9	216.0	12.9	12.9
Actuated g/C Ratio	0.86	0.86		0.02	0.90	0.05	0.05
Clearance Time (s)	5.0	5.0		5.0	5.0	5.0	5.0
Vehicle Extension (s)	3.0	3.0		3.0	3.0	3.0	3.0
Lane Grp Cap (vph)	3053	1318		36	5793	95	85
v/s Ratio Prot	0.36			0.01	c0.80	c0.03	
v/s Ratio Perm		0.01					0.00
v/c Ratio	0.42	0.01		0.36	0.88	0.63	0.01
Uniform Delay, d1	3.5	2.3		115.5	5.4	110.7	106.9
Progression Factor	1.00	1.00		1.00	1.00	1.00	1.00
Incremental Delay, d2	0.1	0.0		6.1	1.8	12.9	0.0
Delay (s)	3.6	2.3		121.5	7.3	123.6	107.0
Level of Service	A	A		F	A	F	F
Approach Delay (s)	3.6				7.5	121.4	
Approach LOS	A				A	F	

Intersection Summary

HCM 2000 Control Delay	8.0	HCM 2000 Level of Service	A
HCM 2000 Volume to Capacity ratio	0.89		
Actuated Cycle Length (s)	238.9	Sum of lost time (s)	15.0
Intersection Capacity Utilization	81.3%	ICU Level of Service	D
Analysis Period (min)	15		

c Critical Lane Group

HCM Unsignalized Intersection Capacity Analysis

19: W Hind Drive & Makalena St

11/28/2014



Movement	EBL	EBT	EBR	WBL	WBT	WBR	NBL	NBT	NBR	SBL	SBT	SBR
Lane Configurations					↕			↕			↕	
Volume (veh/h)	0	0	0	5	0	3	59	147	7	0	356	11
Sign Control		Stop			Stop			Free			Free	
Grade		0%			0%			0%			0%	
Peak Hour Factor	0.89	0.89	0.89	0.89	0.89	0.89	0.89	0.89	0.89	0.89	0.89	0.89
Hourly flow rate (vph)	0	0	0	6	0	3	66	165	8	0	400	12
Pedestrians		6			18			2			2	
Lane Width (ft)		0.0			12.0			12.0			12.0	
Walking Speed (ft/s)		4.0			4.0			4.0			4.0	
Percent Blockage		0			1			0			0	
Right turn flare (veh)												
Median type								None			None	
Median storage veh												
Upstream signal (ft)								568				
pX, platoon unblocked												
vC, conflicting volume	633	736	412	726	738	107	418			191		
vC1, stage 1 conf vol												
vC2, stage 2 conf vol												
vCu, unblocked vol	633	736	412	726	738	107	418			191		
tC, single (s)	7.5	6.5	6.9	*6.5	6.5	*5.9	4.1			4.1		
tC, 2 stage (s)												
tF (s)	3.5	4.0	3.3	3.5	4.0	3.3	2.2			2.2		
p0 queue free %	100	100	100	98	100	100	94			100		
cM capacity (veh/h)	342	320	589	358	319	940	1137			1359		

Direction, Lane #	WB 1	NB 1	NB 2	SB 1
Volume Total	9	149	90	412
Volume Left	6	66	0	0
Volume Right	3	0	8	12
cSH	467	1137	1700	1359
Volume to Capacity	0.02	0.06	0.05	0.00
Queue Length 95th (ft)	1	5	0	0
Control Delay (s)	12.9	4.0	0.0	0.0
Lane LOS	B	A		
Approach Delay (s)	12.9	2.5		0.0
Approach LOS	B			

Intersection Summary			
Average Delay		1.1	
Intersection Capacity Utilization	42.7%	ICU Level of Service	A
Analysis Period (min)	15		

* User Entered Value

HCM Unsignalized Intersection Capacity Analysis
 20: W Hind Drive & School Dwy/Nenu St

11/28/2014



Movement	EBL	EBT	EBR	WBL	WBT	WBR	NBL	NBT	NBR	SBL	SBT	SBR
Lane Configurations		↔			↔			↔			↔	
Volume (veh/h)	5	2	23	8	3	3	33	100	17	11	336	14
Sign Control		Stop			Stop			Free			Free	
Grade		0%			0%			0%			0%	
Peak Hour Factor	0.93	0.93	0.93	0.93	0.93	0.93	0.93	0.93	0.93	0.93	0.93	0.93
Hourly flow rate (vph)	5	2	25	9	3	3	35	108	18	12	361	15
Pedestrians		3										
Lane Width (ft)		12.0										
Walking Speed (ft/s)		4.0										
Percent Blockage		0										
Right turn flare (veh)												
Median type								None			None	
Median storage (veh)												
Upstream signal (ft)								854				
pX, platoon unblocked												
vC, conflicting volume	588	592	372	606	591	117	379			126		
vC1, stage 1 conf vol												
vC2, stage 2 conf vol												
vCu, unblocked vol	588	592	372	606	591	117	379			126		
tC, single (s)	*6.1	*5.5	*5.2	*6.1	*5.5	*5.2	4.1			4.1		
tC, 2 stage (s)												
tF (s)	3.5	4.0	3.3	3.5	4.0	3.3	2.2			2.2		
p0 queue free %	99	100	97	98	99	100	97			99		
cM capacity (veh/h)	476	475	747	454	476	967	1176			1461		

Direction, Lane #	EB 1	WB 1	NB 1	SB 1
Volume Total	32	15	161	388
Volume Left	5	9	35	12
Volume Right	25	3	18	15
cSH	659	518	1176	1461
Volume to Capacity	0.05	0.03	0.03	0.01
Queue Length 95th (ft)	4	2	2	1
Control Delay (s)	10.7	12.2	2.0	0.3
Lane LOS	B	B	A	A
Approach Delay (s)	10.7	12.2	2.0	0.3
Approach LOS	B	B		

Intersection Summary			
Average Delay		1.6	
Intersection Capacity Utilization		32.9%	ICU Level of Service A
Analysis Period (min)		15	

* User Entered Value

HCM Signalized Intersection Capacity Analysis
 4: Church Dwy/Nenuue St & Kalaniana'ole Hwy

11/28/2014

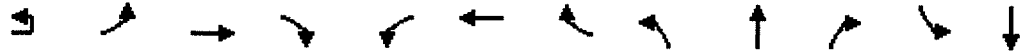

Movement	EBU	EBL	EBT	EBR	WBL	WBT	WBR	NBL	NBT	NBR	SBL	SBT
Lane Configurations		↔	↑↑↑		↔	↑↑↑			↔			↔
Volume (vph)	7	11	3134	2	7	1621	97	0	0	0	238	1
Ideal Flow (vphpl)	1900	1900	1900	1900	1900	1900	1900	1900	1900	1900	1900	1900
Total Lost time (s)		5.0	5.0		5.0	5.0						5.0
Lane Util. Factor		1.00	0.91		1.00	0.91						1.00
Frb, ped/bikes		1.00	1.00		1.00	1.00						1.00
Flpb, ped/bikes		1.00	1.00		1.00	1.00						1.00
Frt		1.00	1.00		1.00	0.99						1.00
Flt Protected		0.95	1.00		0.95	1.00						0.95
Satd. Flow (prot)		1770	5085		1770	5033						1774
Flt Permitted		0.95	1.00		0.95	1.00						0.73
Satd. Flow (perm)		1770	5085		1770	5033						1355
Peak-hour factor, PHF	0.95	0.95	0.95	0.95	0.95	0.95	0.95	0.95	0.95	0.95	0.95	0.95
Adj. Flow (vph)	7	12	3299	2	7	1706	102	0	0	0	251	1
RTOR Reduction (vph)	0	0	0	0	0	3	0	0	0	0	0	0
Lane Group Flow (vph)	0	19	3301	0	7	1805	0	0	0	0	0	252
Confl. Peds. (#/hr)							3					
Turn Type	Prot	Prot	NA		Prot	NA					Perm	NA
Protected Phases	5	5	2		1	6			8			4
Permitted Phases								8			4	
Actuated Green, G (s)		3.2	91.1		1.3	89.2						30.0
Effective Green, g (s)		3.2	91.1		1.3	89.2						30.0
Actuated g/C Ratio		0.02	0.66		0.01	0.65						0.22
Clearance Time (s)		5.0	5.0		5.0	5.0						5.0
Vehicle Extension (s)		3.0	3.0		3.0	3.0						3.0
Lane Grp Cap (vph)		41	3371		16	3267						295
v/s Ratio Prot		c0.01	c0.65		0.00	0.36						
v/s Ratio Perm												c0.19
v/c Ratio		0.46	0.98		0.44	0.55						0.85
Uniform Delay, d1		66.3	22.2		67.7	13.2						51.6
Progression Factor		1.00	1.00		1.00	1.00						1.00
Incremental Delay, d2		8.1	11.0		18.0	0.2						20.7
Delay (s)		74.3	33.2		85.7	13.4						72.3
Level of Service		E	C		F	B						E
Approach Delay (s)			33.5			13.7			0.0			68.8
Approach LOS			C			B			A			E

Intersection Summary		
HCM 2000 Control Delay	28.7	HCM 2000 Level of Service
HCM 2000 Volume to Capacity ratio	0.95	C
Actuated Cycle Length (s)	137.4	Sum of lost time (s)
Intersection Capacity Utilization	82.2%	15.0
Analysis Period (min)	15	ICU Level of Service
		E

c Critical Lane Group

HCM Signalized Intersection Capacity Analysis

4: Church Dwy/Nenu St & Kalaniana'ole Hwy

11/28/2014



Movement	SBR
Lane Configurations	7
Volume (vph)	31
Ideal Flow (vphpl)	1900
Total Lost time (s)	5.0
Lane Util. Factor	1.00
Frbp, ped/bikes	0.98
Ftpb, ped/bikes	1.00
Frt	0.85
Flt Protected	1.00
Satd. Flow (prot)	1544
Flt Permitted	1.00
Satd. Flow (perm)	1544
Peak-hour factor, PHF	0.95
Adj. Flow (vph)	33
RTOR Reduction (vph)	26
Lane Group Flow (vph)	7
Confl. Peds. (#/hr)	5
Turn Type	Perm
Protected Phases	
Permitted Phases	4
Actuated Green, G (s)	30.0
Effective Green, g (s)	30.0
Actuated g/C Ratio	0.22
Clearance Time (s)	5.0
Vehicle Extension (s)	3.0
Lane Grp Cap (vph)	337
v/s Ratio Prot	
v/s Ratio Perm	0.00
v/c Ratio	0.02
Uniform Delay, d1	42.2
Progression Factor	1.00
Incremental Delay, d2	0.0
Delay (s)	42.2
Level of Service	D
Approach Delay (s)	
Approach LOS	
Intersection Summary	

HCM Unsignalized Intersection Capacity Analysis

5: W Hind Dr & School Exit/Shopping Center Dwy

11/28/2014



Movement	EBL	EBT	EBR	WBL	WBT	WBR	NBL	NBT	NBR	SBL	SBT	SBR
Lane Configurations		↔			↔			↑↔			↔↑	
Volume (veh/h)	38	7	23	67	0	53	67	315	124	34	138	0
Sign Control		Stop			Stop			Free			Free	
Grade		0%			0%			0%			0%	
Peak Hour Factor	0.94	0.94	0.94	0.94	0.94	0.94	0.94	0.94	0.94	0.94	0.94	0.94
Hourly flow rate (vph)	40	7	24	71	0	56	71	335	132	36	147	0
Pedestrians												16
Lane Width (ft)												12.0
Walking Speed (ft/s)												4.0
Percent Blockage												1
Right turn flare (veh)												
Median type								None			None	
Median storage (veh)												
Upstream signal (ft)								274				
pX, platoon unblocked												
vC, conflicting volume	602	829	73	718	763	250	147			467		
vC1, stage 1 conf vol												
vC2, stage 2 conf vol												
vCu, unblocked vol	602	829	73	718	763	250	147			467		
tC, single (s)	*6.5	*5.5	*5.9	*6.5	6.5	*5.9	4.1			4.1		
tC, 2 stage (s)												
tF (s)	3.5	4.0	3.3	3.5	4.0	3.3	2.2			2.2		
p0 queue free %	90	98	98	80	100	93	95			97		
cM capacity (veh/h)	393	356	994	351	306	796	1433			1091		

Direction, Lane #	EB 1	WB 1	NB 1	NB 2	SB 1	SB 2
Volume Total	72	128	239	299	85	98
Volume Left	40	71	71	0	36	0
Volume Right	24	56	0	132	0	0
cSH	487	466	1433	1700	1091	1700
Volume to Capacity	0.15	0.27	0.05	0.18	0.03	0.06
Queue Length 95th (ft)	13	28	4	0	3	0
Control Delay (s)	13.7	15.6	2.6	0.0	3.7	0.0
Lane LOS	B	C	A		A	
Approach Delay (s)	13.7	15.6	1.1		1.7	
Approach LOS	B	C				

Intersection Summary		
Average Delay		4.3
Intersection Capacity Utilization	40.3%	ICU Level of Service A
Analysis Period (min)		15

* User Entered Value

HCM Signalized Intersection Capacity Analysis

6: Kalaniana'ole Hwy & W Hind Dr

11/28/2014

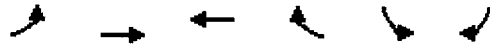

Movement	EBL	EBT	WBT	WBR	SBL	SBR
Lane Configurations	↙↘	↑↑↑	↑↑↑	↗		↗↘
Volume (vph)	624	3147	1608	51	0	379
Ideal Flow (vphpl)	1900	1900	1900	1900	1900	1900
Total Lost time (s)	5.0	5.0	5.0	5.0		5.0
Lane Util. Factor	0.97	0.91	0.91	1.00		0.88
Frbp, ped/bikes	1.00	1.00	1.00	0.96		1.00
Flpb, ped/bikes	1.00	1.00	1.00	1.00		1.00
Frt	1.00	1.00	1.00	0.85		0.85
Flt Protected	0.95	1.00	1.00	1.00		1.00
Satd. Flow (prot)	3433	5085	5085	1528		2787
Flt Permitted	0.95	1.00	1.00	1.00		1.00
Satd. Flow (perm)	3433	5085	5085	1528		2787
Peak-hour factor, PHF	0.94	0.94	0.94	0.94	0.94	0.94
Adj. Flow (vph)	664	3348	1711	54	0	403
RTOR Reduction (vph)	0	0	0	9	0	77
Lane Group Flow (vph)	664	3348	1711	45	0	326
Confl. Peds. (#/hr)				7		7
Turn Type	Prot	NA	NA	Perm		Over
Protected Phases	5	2	6			5
Permitted Phases				6		5
Actuated Green, G (s)	42.1	180.0	127.9	127.9		42.1
Effective Green, g (s)	42.1	180.0	127.9	127.9		42.1
Actuated g/C Ratio	0.23	1.00	0.71	0.71		0.23
Clearance Time (s)	5.0	5.0	5.0	5.0		5.0
Vehicle Extension (s)	3.0	3.0	3.0	3.0		3.0
Lane Grp Cap (vph)	802	5085	3613	1085		651
v/s Ratio Prot	c0.19	c0.66	0.34			0.12
v/s Ratio Perm				0.03		
v/c Ratio	0.83	0.66	0.47	0.04		0.50
Uniform Delay, d1	65.5	0.0	11.4	7.8		59.8
Progression Factor	1.00	1.00	1.00	1.00		1.00
Incremental Delay, d2	7.0	0.3	0.1	0.0		0.6
Delay (s)	72.6	0.3	11.5	7.8		60.5
Level of Service	E	A	B	A		E
Approach Delay (s)		12.3	11.3		60.5	
Approach LOS		B	B		E	

Intersection Summary			
HCM 2000 Control Delay	15.1	HCM 2000 Level of Service	B
HCM 2000 Volume to Capacity ratio	0.72		
Actuated Cycle Length (s)	180.0	Sum of lost time (s)	10.0
Intersection Capacity Utilization	73.7%	ICU Level of Service	D
Analysis Period (min)	15		

c Critical Lane Group

HCM Unsignalized Intersection Capacity Analysis

8: W Hind Dr & Church Dwy/Shopping Center Dwy

11/28/2014



Movement	EBL	EBT	EBR	WBL	WBT	WBR	NBL	NBT	NBR	SBL	SBT	SBR
Lane Configurations		↔			↔			↑↔			↔↑	
Volume (veh/h)	0	0	77	83	0	29	0	477	198	9	219	0
Sign Control		Stop			Stop			Free			Free	
Grade		0%			0%			0%			0%	
Peak Hour Factor	0.94	0.94	0.94	0.94	0.94	0.94	0.94	0.94	0.94	0.94	0.94	0.94
Hourly flow rate (vph)	0	0	82	88	0	31	0	507	211	10	233	0
Pedestrians		5										
Lane Width (ft)		12.0										
Walking Speed (ft/s)		4.0										
Percent Blockage		0										
Right turn flare (veh)												
Median type								None			None	
Median storage veh												
Upstream signal (ft)								144				
pX, platoon unblocked												
vC, conflicting volume	542	975	121	830	870	359	238			718		
vC1, stage 1 conf vol												
vC2, stage 2 conf vol												
vCu, unblocked vol	542	975	121	830	870	359	238			718		
tC, single (s)	7.5	6.5	*5.9	*6.5	6.5	*5.9	4.1			4.1		
tC, 2 stage (s)												
tF (s)	3.5	4.0	3.3	3.5	4.0	3.3	2.2			2.2		
p0 queue free %	100	100	91	71	100	96	100			99		
cM capacity (veh/h)	399	246	935	301	284	707	1321			879		

Direction, Lane #	EB 1	WB 1	NB 1	NB 2	SB 1	SB 2
Volume Total	82	119	338	380	87	155
Volume Left	0	88	0	0	10	0
Volume Right	82	31	0	211	0	0
cSH	935	353	1700	1700	879	1700
Volume to Capacity	0.09	0.34	0.20	0.22	0.01	0.09
Queue Length 95th (ft)	7	36	0	0	1	0
Control Delay (s)	9.2	20.3	0.0	0.0	1.1	0.0
Lane LOS	A	C			A	
Approach Delay (s)	9.2	20.3	0.0		0.4	
Approach LOS	A	C				

Intersection Summary	
Average Delay	2.8
Intersection Capacity Utilization	39.2%
ICU Level of Service	A
Analysis Period (min)	15

* User Entered Value

HCM Signalized Intersection Capacity Analysis

18: Wailupe Cir & Kalaniana'ole Hwy

11/28/2014



Movement	EBT	EBR	WBU	WBL	WBT	NBL	NBR
Lane Configurations	↑↑↑	↑		↔	↑↑↑	↑	↑
Volume (vph)	3714	55	42	16	1895	24	15
Ideal Flow (vphpl)	1900	1900	1900	1900	1900	1900	1900
Total Lost time (s)	5.0	5.0		5.0	5.0	5.0	5.0
Lane Util. Factor	0.91	1.00		1.00	0.91	1.00	1.00
Frbp, ped/bikes	1.00	0.97		1.00	1.00	1.00	0.98
Flpb, ped/bikes	1.00	1.00		1.00	1.00	1.00	1.00
Frt	1.00	0.85		1.00	1.00	1.00	0.85
Flt Protected	1.00	1.00		0.95	1.00	0.95	1.00
Satd. Flow (prot)	5085	1544		1770	5085	1770	1560
Flt Permitted	1.00	1.00		0.95	1.00	0.95	1.00
Satd. Flow (perm)	5085	1544		1770	5085	1770	1560
Peak-hour factor, PHF	0.94	0.94	0.94	0.94	0.94	0.94	0.94
Adj. Flow (vph)	3951	59	45	17	2016	26	16
RTOR Reduction (vph)	0	6	0	0	0	0	15
Lane Group Flow (vph)	3951	53	0	62	2016	26	1
Confl. Peds. (#/hr)		1					1
Turn Type	NA	Perm	Prot	Prot	NA	Prot	Perm
Protected Phases	2		1	1	6	8	
Permitted Phases		2					8
Actuated Green, G (s)	132.9	132.9		9.5	147.4	6.6	6.6
Effective Green, g (s)	132.9	132.9		9.5	147.4	6.6	6.6
Actuated g/C Ratio	0.81	0.81		0.06	0.90	0.04	0.04
Clearance Time (s)	5.0	5.0		5.0	5.0	5.0	5.0
Vehicle Extension (s)	3.0	3.0		3.0	3.0	3.0	3.0
Lane Grp Cap (vph)	4120	1251		102	4570	71	62
v/s Ratio Prot	c0.78			c0.04	0.40	c0.01	
v/s Ratio Perm		0.03					0.00
v/c Ratio	0.96	0.04		0.61	0.44	0.37	0.01
Uniform Delay, d1	13.2	3.1		75.4	1.4	76.7	75.6
Progression Factor	1.00	1.00		1.00	1.00	1.00	1.00
Incremental Delay, d2	6.9	0.0		9.8	0.1	3.2	0.1
Delay (s)	20.1	3.1		85.3	1.5	79.8	75.6
Level of Service	C	A		F	A	E	E
Approach Delay (s)	19.8				4.0	78.2	
Approach LOS	B				A	E	

Intersection Summary			
HCM 2000 Control Delay	14.9	HCM 2000 Level of Service	B
HCM 2000 Volume to Capacity ratio	0.91		
Actuated Cycle Length (s)	164.0	Sum of lost time (s)	15.0
Intersection Capacity Utilization	83.8%	ICU Level of Service	E
Analysis Period (min)	15		

c Critical Lane Group

HCM Unsignalized Intersection Capacity Analysis
 19: W Hind Dr & Makalena St

11/28/2014



Movement	EBL	EBT	EBR	WBL	WBT	WBR	NBL	NBT	NBR	SBL	SBT	SBR
Lane Configurations					↕			↕			↕	
Volume (veh/h)	0	0	0	5	0	3	23	358	24	0	168	6
Sign Control		Stop			Stop			Free			Free	
Grade		0%			0%			0%			0%	
Peak Hour Factor	0.96	0.96	0.96	0.96	0.96	0.96	0.96	0.96	0.96	0.96	0.96	0.96
Hourly flow rate (vph)	0	0	0	5	0	3	24	373	25	0	175	6
Pedestrians		1			11						3	
Lane Width (ft)		0.0			12.0						12.0	
Walking Speed (ft/s)		4.0			4.0						4.0	
Percent Blockage		0			1						0	
Right turn flare (veh)												
Median type								None			None	
Median storage veh												
Upstream signal (ft)								568				
pX, platoon unblocked												
vC, conflicting volume	420	636	179	622	627	213	182			409		
vC1, stage 1 conf vol												
vC2, stage 2 conf vol												
vCu, unblocked vol	420	636	179	622	627	213	182			409		
tC, single (s)	7.5	6.5	6.9	*6.5	6.5	*5.9	4.1			4.1		
tC, 2 stage (s)												
tF (s)	3.5	4.0	3.3	3.5	4.0	3.3	2.2			2.2		
p0 queue free %	100	100	100	99	100	100	98			100		
cM capacity (veh/h)	504	384	833	431	388	833	1390			1136		

Direction, Lane #	WB 1	NB 1	NB 2	SB 1
Volume Total	8	210	211	181
Volume Left	5	24	0	0
Volume Right	3	0	25	6
cSH	526	1390	1700	1136
Volume to Capacity	0.02	0.02	0.12	0.00
Queue Length 95th (ft)	1	1	0	0
Control Delay (s)	12.0	1.0	0.0	0.0
Lane LOS	B	A		
Approach Delay (s)	12.0	0.5		0.0
Approach LOS	B			

Intersection Summary			
Average Delay		0.5	
Intersection Capacity Utilization		35.6%	ICU Level of Service A
Analysis Period (min)		15	

* User Entered Value

HCM Unsignalized Intersection Capacity Analysis

20: W Hind Dr & School Dwy/Nenu St

11/28/2014



Movement	EBL	EBT	EBR	WBL	WBT	WBR	NBL	NBT	NBR	SBL	SBT	SBR
Lane Configurations		↔			↔			↔			↔	
Volume (veh/h)	21	8	18	3	0	7	25	294	42	9	153	7
Sign Control		Stop			Stop			Free			Free	
Grade		0%			0%			0%			0%	
Peak Hour Factor	0.91	0.91	0.91	0.91	0.91	0.91	0.91	0.91	0.91	0.91	0.91	0.91
Hourly flow rate (vph)	23	9	20	3	0	8	27	323	46	10	168	8
Pedestrians		5										
Lane Width (ft)		12.0										
Walking Speed (ft/s)		4.0										
Percent Blockage		0										
Right turn flare (veh)												
Median type								None			None	
Median storage veh												
Upstream signal (ft)								854				
pX, platoon unblocked												
vC, conflicting volume	606	621	177	617	602	346	181			369		
vC1, stage 1 conf vol												
vC2, stage 2 conf vol												
vCu, unblocked vol	606	621	177	617	602	346	181			369		
tC, single (s)	*6.1	*5.5	*5.2	*6.1	6.5	*5.2	4.1			4.1		
tC, 2 stage (s)												
tF (s)	3.5	4.0	3.3	3.5	4.0	3.3	2.2			2.2		
p0 queue free %	95	98	98	99	100	99	98			99		
cM capacity (veh/h)	467	466	907	451	400	769	1389			1189		

Direction, Lane #	EB 1	WB 1	NB 1	SB 1
Volume Total	52	11	397	186
Volume Left	23	3	27	10
Volume Right	20	8	46	8
cSH	573	634	1389	1189
Volume to Capacity	0.09	0.02	0.02	0.01
Queue Length 95th (ft)	7	1	2	1
Control Delay (s)	11.9	10.8	0.7	0.5
Lane LOS	B	B	A	A
Approach Delay (s)	11.9	10.8	0.7	0.5
Approach LOS	B	B		

Intersection Summary			
Average Delay		1.7	
Intersection Capacity Utilization		37.3%	ICU Level of Service A
Analysis Period (min)		15	

* User Entered Value

APPENDIX F

CAPACITY ANALYSIS CALCULATIONS
PROJECTED YEAR 2015 PEAK HOUR TRAFFIC ANALYSIS
WITH ALTERNATIVE 2

HCM Signalized Intersection Capacity Analysis

4: Church Dwy/Nenuue St & Kalanianaole Hwy

11/28/2014



Movement	EBL	EBT	EBR	WBL	WBT	WBR	NBL	NBT	NBR	SBL	SBT	SBR
Lane Configurations		↑↑			↑↑↑↑			↑↓			↑↓	↑↓
Volume (vph)	0	1001	18	0	4418	145	0	4	1	78	2	63
Ideal Flow (vphpl)	1900	1900	1900	1900	1900	1900	1900	1900	1900	1900	1900	1900
Total Lost time (s)		5.0			5.0			5.0			5.0	5.0
Lane Util. Factor		0.95			0.86			1.00			1.00	1.00
Frb, ped/bikes		1.00			1.00			1.00			1.00	0.93
Flpb, ped/bikes		1.00			1.00			1.00			1.00	1.00
Frt		1.00			1.00			0.97			1.00	0.85
Flt Protected		1.00			1.00			1.00			0.95	1.00
Satd. Flow (prot)		3530			6377			1812			1776	1476
Flt Permitted		1.00			1.00			1.00			0.73	1.00
Satd. Flow (perm)		3530			6377			1812			1356	1476
Peak-hour factor, PHF	0.96	0.96	0.96	0.96	0.96	0.96	0.96	0.96	0.96	0.96	0.96	0.96
Adj. Flow (vph)	0	1043	19	0	4602	151	0	4	1	81	2	66
RTOR Reduction (vph)	0	0	0	0	2	0	0	1	0	0	0	8
Lane Group Flow (vph)	0	1062	0	0	4751	0	0	4	0	0	83	58
Confl. Peds. (#/hr)												13
Turn Type		NA			NA			NA		Perm	NA	Perm
Protected Phases		2			6			8			4	
Permitted Phases							8			4		4
Actuated Green, G (s)		205.1			205.1			19.0			19.0	19.0
Effective Green, g (s)		205.1			205.1			19.0			19.0	19.0
Actuated g/C Ratio		0.88			0.88			0.08			0.08	0.08
Clearance Time (s)		5.0			5.0			5.0			5.0	5.0
Vehicle Extension (s)		3.0			3.0			3.0			3.0	3.0
Lane Grp Cap (vph)		3092			5587			147			110	119
v/s Ratio Prot		0.30			c0.75			0.00				
v/s Ratio Perm											c0.06	0.04
v/c Ratio		0.34			0.85			0.03			0.75	0.49
Uniform Delay, d1		2.6			7.0			99.0			105.3	102.9
Progression Factor		1.00			1.00			1.00			1.00	1.00
Incremental Delay, d2		0.1			1.4			0.1			25.0	3.1
Delay (s)		2.6			8.4			99.1			130.3	106.0
Level of Service		A			A			F			F	F
Approach Delay (s)		2.6			8.4			99.1			119.5	
Approach LOS		A			A			F			F	

Intersection Summary			
HCM 2000 Control Delay	10.2	HCM 2000 Level of Service	B
HCM 2000 Volume to Capacity ratio	0.84		
Actuated Cycle Length (s)	234.1	Sum of lost time (s)	10.0
Intersection Capacity Utilization	90.3%	ICU Level of Service	E
Analysis Period (min)	15		

c Critical Lane Group

HCM Unsignalized Intersection Capacity Analysis

5: W Hind Dr & School Exit/Shopping Center Dwy

11/28/2014



Movement	EBL	EBT	EBR	WBL	WBT	WBR	NBL	NBT	NBR	SBL	SBT	SBR
Lane Configurations		↔			↔			↑↔			↔↑	
Volume (veh/h)	8	7	17	63	0	37	0	181	10	42	318	0
Sign Control		Stop			Stop			Free			Free	
Grade		0%			0%			0%			0%	
Peak Hour Factor	0.87	0.87	0.87	0.87	0.87	0.87	0.87	0.87	0.87	0.87	0.87	0.87
Hourly flow rate (vph)	9	8	20	72	0	43	0	208	11	48	366	0
Pedestrians											11	
Lane Width (ft)											12.0	
Walking Speed (ft/s)											4.0	
Percent Blockage											1	
Right turn flare (veh)												
Median type								None			None	
Median storage veh												
Upstream signal (ft)								274				
pX, platoon unblocked												
vC, conflicting volume	620	682	183	517	676	121	366			220		
vC1, stage 1 conf vol												
vC2, stage 2 conf vol												
vCu, unblocked vol	620	682	183	517	676	121	366			220		
tC, single (s)	*6.5	*5.5	*5.9	*6.5	6.5	*5.9	4.1			4.1		
tC, 2 stage (s)												
tF (s)	3.5	4.0	3.3	3.5	4.0	3.3	2.2			2.2		
p0 queue free %	98	98	98	85	100	95	100			96		
cM capacity (veh/h)	410	435	873	481	360	931	1190			1347		

Direction, Lane #	EB 1	WB 1	NB 1	NB 2	SB 1	SB 2
Volume Total	37	115	139	81	170	244
Volume Left	9	72	0	0	48	0
Volume Right	20	43	0	11	0	0
cSH	581	585	1700	1700	1347	1700
Volume to Capacity	0.06	0.20	0.08	0.05	0.04	0.14
Queue Length 95th (ft)	5	18	0	0	3	0
Control Delay (s)	11.6	12.6	0.0	0.0	2.4	0.0
Lane LOS	B	B			A	
Approach Delay (s)	11.6	12.6	0.0		1.0	
Approach LOS	B	B				

Intersection Summary		
Average Delay		2.9
Intersection Capacity Utilization	38.3%	ICU Level of Service A
Analysis Period (min)		15

* User Entered Value

HCM Signalized Intersection Capacity Analysis

6: Kalaniana'ole Hwy & W Hind Dr

11/28/2014



Movement	EBL	EBT	WBT	WBR	SBL	SBR
Lane Configurations						
Volume (vph)	208	1013	4410	71	0	454
Ideal Flow (vphpl)	1900	1900	1900	1900	1900	1900
Total Lost time (s)	5.0	5.0	5.0	5.0		5.0
Lane Util. Factor	0.97	0.95	0.86	1.00		0.88
Frbp, ped/bikes	1.00	1.00	1.00	0.98		1.00
Flpb, ped/bikes	1.00	1.00	1.00	1.00		1.00
Frt	1.00	1.00	1.00	0.85		0.85
Flt Protected	0.95	1.00	1.00	1.00		1.00
Satd. Flow (prot)	3433	3539	6408	1557		2787
Flt Permitted	0.95	1.00	1.00	1.00		1.00
Satd. Flow (perm)	3433	3539	6408	1557		2787
Peak-hour factor, PHF	0.95	0.95	0.95	0.95	0.95	0.95
Adj. Flow (vph)	219	1066	4642	75	0	478
RTOR Reduction (vph)	0	0	0	5	0	84
Lane Group Flow (vph)	219	1066	4642	70	0	394
Confl. Peds. (#/hr)				1		1
Turn Type	Prot	NA	NA	Perm		Over
Protected Phases	5	2	6			5
Permitted Phases				6		5
Actuated Green, G (s)	36.9	235.0	188.1	188.1		36.9
Effective Green, g (s)	36.9	235.0	188.1	188.1		36.9
Actuated g/C Ratio	0.16	1.00	0.80	0.80		0.16
Clearance Time (s)	5.0	5.0	5.0	5.0		5.0
Vehicle Extension (s)	3.0	3.0	3.0	3.0		3.0
Lane Grp Cap (vph)	539	3539	5129	1246		437
v/s Ratio Prot	0.06	0.30	c0.72			c0.14
v/s Ratio Perm				0.04		
v/c Ratio	0.41	0.30	0.91	0.06		0.90
Uniform Delay, d1	89.2	0.0	17.0	4.9		97.3
Progression Factor	1.00	1.00	1.00	1.00		1.00
Incremental Delay, d2	0.5	0.0	2.6	0.0		21.3
Delay (s)	89.7	0.0	19.6	4.9		118.5
Level of Service	F	A	B	A		F
Approach Delay (s)		15.3	19.4		118.5	
Approach LOS		B	B		F	

Intersection Summary				
HCM 2000 Control Delay		25.9	HCM 2000 Level of Service	C
HCM 2000 Volume to Capacity ratio		0.90		
Actuated Cycle Length (s)		235.0	Sum of lost time (s)	10.0
Intersection Capacity Utilization		88.2%	ICU Level of Service	E
Analysis Period (min)		15		

c Critical Lane Group

HCM Unsignalized Intersection Capacity Analysis
 8: W Hind Dr & Project Dwy/Shopping Center Dwy

11/28/2014



Movement	EBL	EBT	EBR	WBL	WBT	WBR	NBL	NBT	NBR	SBL	SBT	SBR
Lane Configurations		↔			↔			↑↔			↔↑	
Volume (veh/h)	2	0	23	40	0	18	0	172	107	6	391	0
Sign Control		Stop			Stop			Free			Free	
Grade		0%			0%			0%			0%	
Peak Hour Factor	0.93	0.93	0.93	0.93	0.93	0.93	0.93	0.93	0.93	0.93	0.93	0.93
Hourly flow rate (vph)	2	0	25	43	0	19	0	185	115	6	420	0
Pedestrians		4						4			4	
Lane Width (ft)		12.0						12.0			12.0	
Walking Speed (ft/s)		4.0						4.0			4.0	
Percent Blockage		0						0			0	
Right turn flare (veh)												
Median type								None			None	
Median storage veh												
Upstream signal (ft)								144				
pX, platoon unblocked												
vC, conflicting volume	553	737	218	494	680	154	424			300		
vC1, stage 1 conf vol												
vC2, stage 2 conf vol												
vCu, unblocked vol	553	737	218	494	680	154	424			300		
tC, single (s)	*6.5	6.5	*5.9	*6.5	6.5	*5.9	4.1			4.1		
tC, 2 stage (s)												
tF (s)	3.5	4.0	3.3	3.5	4.0	3.3	2.2			2.2		
p0 queue free %	100	100	97	92	100	98	100			99		
cM capacity (veh/h)	471	341	832	508	369	901	1128			1258		

Direction, Lane #	EB 1	WB 1	NB 1	NB 2	SB 1	SB 2
Volume Total	27	62	123	177	147	280
Volume Left	2	43	0	0	6	0
Volume Right	25	19	0	115	0	0
cSH	784	587	1700	1700	1258	1700
Volume to Capacity	0.03	0.11	0.07	0.10	0.01	0.16
Queue Length 95th (ft)	3	9	0	0	0	0
Control Delay (s)	9.8	11.9	0.0	0.0	0.4	0.0
Lane LOS	A	B			A	
Approach Delay (s)	9.8	11.9	0.0		0.1	
Approach LOS	A	B				

Intersection Summary		
Average Delay		1.3
Intersection Capacity Utilization	31.7%	ICU Level of Service A
Analysis Period (min)		15

* User Entered Value

HCM Signalized Intersection Capacity Analysis
 18: Wailupe Cir & Kalaniana'ole Hwy

11/28/2014



Movement	EBT	EBR	WBU	WBL	WBT	NBL	NBR
Lane Configurations	↑↑	↗		↘	↑↑↑	↖	↗
Volume (vph)	1210	15	3	9	4805	56	8
Ideal Flow (vphpl)	1900	1900	1900	1900	1900	1900	1900
Total Lost time (s)	5.0	5.0		5.0	5.0	5.0	5.0
Lane Util. Factor	0.95	1.00		1.00	0.86	1.00	1.00
Frbp, ped/bikes	1.00	0.97		1.00	1.00	1.00	1.00
Flpb, ped/bikes	1.00	1.00		1.00	1.00	1.00	1.00
Frt	1.00	0.85		1.00	1.00	1.00	0.85
Flt Protected	1.00	1.00		0.95	1.00	0.95	1.00
Satd. Flow (prot)	3539	1528		1770	6408	1770	1583
Flt Permitted	1.00	1.00		0.95	1.00	0.95	1.00
Satd. Flow (perm)	3539	1528		1770	6408	1770	1583
Peak-hour factor, PHF	0.94	0.94	0.94	0.94	0.94	0.94	0.94
Adj. Flow (vph)	1287	16	3	10	5112	60	9
RTOR Reduction (vph)	0	2	0	0	0	0	9
Lane Group Flow (vph)	1287	14	0	13	5112	60	0
Confl. Peds. (#/hr)		2					
Turn Type	NA	Perm	Prot	Prot	NA	Prot	Perm
Protected Phases	2		1	1	6	8	
Permitted Phases		2					8
Actuated Green, G (s)	206.1	206.1		4.9	216.0	12.9	12.9
Effective Green, g (s)	206.1	206.1		4.9	216.0	12.9	12.9
Actuated g/C Ratio	0.86	0.86		0.02	0.90	0.05	0.05
Clearance Time (s)	5.0	5.0		5.0	5.0	5.0	5.0
Vehicle Extension (s)	3.0	3.0		3.0	3.0	3.0	3.0
Lane Grp Cap (vph)	3053	1318		36	5793	95	85
v/s Ratio Prot	0.36			0.01	c0.80	c0.03	
v/s Ratio Perm		0.01					0.00
v/c Ratio	0.42	0.01		0.36	0.88	0.63	0.01
Uniform Delay, d1	3.5	2.3		115.5	5.4	110.7	106.9
Progression Factor	1.00	1.00		1.00	1.00	1.00	1.00
Incremental Delay, d2	0.1	0.0		6.1	1.8	12.9	0.0
Delay (s)	3.6	2.3		121.5	7.3	123.6	107.0
Level of Service	A	A		F	A	F	F
Approach Delay (s)	3.6				7.5	121.4	
Approach LOS	A				A	F	

Intersection Summary

HCM 2000 Control Delay	8.0	HCM 2000 Level of Service	A
HCM 2000 Volume to Capacity ratio	0.89		
Actuated Cycle Length (s)	238.9	Sum of lost time (s)	15.0
Intersection Capacity Utilization	81.3%	ICU Level of Service	D
Analysis Period (min)	15		

c Critical Lane Group

HCM Unsignalized Intersection Capacity Analysis
 19: W Hind Dr & Makalena St

11/28/2014



Movement	EBL	EBT	EBR	WBL	WBT	WBR	NBL	NBT	NBR	SBL	SBT	SBR
Lane Configurations					↕			↕			↕	
Volume (veh/h)	0	0	0	5	0	3	59	151	7	0	356	11
Sign Control		Stop			Stop			Free			Free	
Grade		0%			0%			0%			0%	
Peak Hour Factor	0.89	0.89	0.89	0.89	0.89	0.89	0.89	0.89	0.89	0.89	0.89	0.89
Hourly flow rate (vph)	0	0	0	6	0	3	66	170	8	0	400	12
Pedestrians		6			18						2	
Lane Width (ft)		0.0			12.0						12.0	
Walking Speed (ft/s)		4.0			4.0						4.0	
Percent Blockage		0			1						0	
Right turn flare (veh)												
Median type								None			None	
Median storage (veh)												
Upstream signal (ft)								568				
pX, platoon unblocked												
vC, conflicting volume	635	740	412	730	743	109	418			196		
vC1, stage 1 conf vol												
vC2, stage 2 conf vol												
vCu, unblocked vol	635	740	412	730	743	109	418			196		
tC, single (s)	7.5	6.5	6.9	*6.5	6.5	*5.9	4.1			4.1		
tC, 2 stage (s)												
tF (s)	3.5	4.0	3.3	3.5	4.0	3.3	2.2			2.2		
p0 queue free %	100	100	100	98	100	100	94			100		
cM capacity (veh/h)	341	318	589	356	317	938	1137			1354		

Direction, Lane #	WB 1	NB 1	NB 2	SB 1
Volume Total	9	151	93	412
Volume Left	6	66	0	0
Volume Right	3	0	8	12
cSH	464	1137	1700	1354
Volume to Capacity	0.02	0.06	0.05	0.00
Queue Length 95th (ft)	1	5	0	0
Control Delay (s)	12.9	4.0	0.0	0.0
Lane LOS	B	A		
Approach Delay (s)	12.9	2.5		0.0
Approach LOS	B			

Intersection Summary			
Average Delay		1.1	
Intersection Capacity Utilization		42.8%	ICU Level of Service A
Analysis Period (min)		15	

* User Entered Value

HCM Unsignalized Intersection Capacity Analysis
 20: W Hind Dr & School Dwy/Nenu St

11/28/2014



Movement	EBL	EBT	EBR	WBL	WBT	WBR	NBL	NBT	NBR	SBL	SBT	SBR
Lane Configurations		↕			↕			↕			↕	
Volume (veh/h)	5	2	23	8	3	3	33	100	26	11	336	14
Sign Control		Stop			Stop			Free			Free	
Grade		0%			0%			0%			0%	
Peak Hour Factor	0.93	0.93	0.93	0.93	0.93	0.93	0.93	0.93	0.93	0.93	0.93	0.93
Hourly flow rate (vph)	5	2	25	9	3	3	35	108	28	12	361	15
Pedestrians		3										
Lane Width (ft)		12.0										
Walking Speed (ft/s)		4.0										
Percent Blockage		0										
Right turn flare (veh)												
Median type								None			None	
Median storage (veh)												
Upstream signal (ft)								854				
pX, platoon unblocked												
vC, conflicting volume	593	602	372	611	595	122	379			135		
vC1, stage 1 conf vol												
vC2, stage 2 conf vol												
vCu, unblocked vol	593	602	372	611	595	122	379			135		
tC, single (s)	*6.1	*5.5	*5.2	*6.1	*5.5	*5.2	4.1			4.1		
tC, 2 stage (s)												
tF (s)	3.5	4.0	3.3	3.5	4.0	3.3	2.2			2.2		
p0 queue free %	99	100	97	98	99	100	97			99		
cM capacity (veh/h)	473	471	747	451	474	962	1176			1449		

Direction, Lane #	EB 1	WB 1	NB 1	SB 1
Volume Total	32	15	171	388
Volume Left	5	9	35	12
Volume Right	25	3	28	15
cSH	658	515	1176	1449
Volume to Capacity	0.05	0.03	0.03	0.01
Queue Length 95th (ft)	4	2	2	1
Control Delay (s)	10.8	12.2	1.9	0.3
Lane LOS	B	B	A	A
Approach Delay (s)	10.8	12.2	1.9	0.3
Approach LOS	B	B		

Intersection Summary			
Average Delay		1.6	
Intersection Capacity Utilization		33.5%	ICU Level of Service A
Analysis Period (min)		15	

* User Entered Value

HCM Signalized Intersection Capacity Analysis

4: Church Dwy/Nenuue St & Kalaniana'ole Hwy

11/28/2014

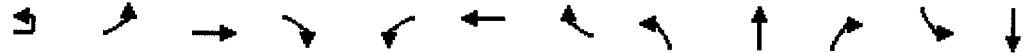

Movement	EBU	EBL	EBT	EBR	WBL	WBT	WBR	NBL	NBT	NBR	SBL	SBT
Lane Configurations		↔	↑↑↑		↔	↑↑↑			↕			↔
Volume (vph)	47	38	3134	2	7	1621	97	0	0	0	238	1
Ideal Flow (vphpl)	1900	1900	1900	1900	1900	1900	1900	1900	1900	1900	1900	1900
Total Lost time (s)		5.0	5.0		5.0	5.0						5.0
Lane Util. Factor		1.00	0.91		1.00	0.91						1.00
Frbp, ped/bikes		1.00	1.00		1.00	1.00						1.00
Flpb, ped/bikes		1.00	1.00		1.00	1.00						1.00
Frt		1.00	1.00		1.00	0.99						1.00
Flt Protected		0.95	1.00		0.95	1.00						0.95
Satd. Flow (prot)		1770	5085		1770	5033						1774
Flt Permitted		0.95	1.00		0.95	1.00						0.73
Satd. Flow (perm)		1770	5085		1770	5033						1355
Peak-hour factor, PHF	0.95	0.95	0.95	0.95	0.95	0.95	0.95	0.95	0.95	0.95	0.95	0.95
Adj. Flow (vph)	49	40	3299	2	7	1706	102	0	0	0	251	1
RTOR Reduction (vph)	0	0	0	0	0	4	0	0	0	0	0	0
Lane Group Flow (vph)	0	89	3301	0	7	1804	0	0	0	0	0	252
Confl. Peds. (#/hr)							3					
Turn Type	Prot	Prot	NA		Prot	NA					Perm	NA
Protected Phases	5	5	2		1	6			8			4
Permitted Phases								8			4	
Actuated Green, G (s)		12.1	91.1		1.4	80.4						30.0
Effective Green, g (s)		12.1	91.1		1.4	80.4						30.0
Actuated g/C Ratio		0.09	0.66		0.01	0.58						0.22
Clearance Time (s)		5.0	5.0		5.0	5.0						5.0
Vehicle Extension (s)		3.0	3.0		3.0	3.0						3.0
Lane Grp Cap (vph)		155	3369		18	2942						295
v/s Ratio Prot		c0.05	c0.65		0.00	0.36						
v/s Ratio Perm												c0.19
v/c Ratio		0.57	0.98		0.39	0.61						0.85
Uniform Delay, d1		60.2	22.3		67.6	18.5						51.6
Progression Factor		1.00	1.00		1.00	1.00						1.00
Incremental Delay, d2		5.1	11.1		13.4	0.4						20.7
Delay (s)		65.3	33.4		81.0	18.9						72.3
Level of Service		E	C		F	B						E
Approach Delay (s)			34.3			19.1			0.0			68.8
Approach LOS			C			B			A			E
Intersection Summary												
HCM 2000 Control Delay			31.0									
HCM 2000 Volume to Capacity ratio			0.96									
Actuated Cycle Length (s)			137.5						15.0			
Intersection Capacity Utilization			89.7%									
Analysis Period (min)			15									
c Critical Lane Group												

HCM Signalized Intersection Capacity Analysis
 4: Church Dwy/Nenuue St & Kalaniana'ole Hwy

11/28/2014



Movement	SBR
Lane Configurations	7
Volume (vph)	31
Ideal Flow (vphpl)	1900
Total Lost time (s)	5.0
Lane Util. Factor	1.00
Frbp, ped/bikes	0.98
Flpb, ped/bikes	1.00
Frt	0.85
Flt Protected	1.00
Satd. Flow (prot)	1544
Flt Permitted	1.00
Satd. Flow (perm)	1544
Peak-hour factor, PHF	0.95
Adj. Flow (vph)	33
RTOR Reduction (vph)	26
Lane Group Flow (vph)	7
Confl. Peds. (#/hr)	5
Turn Type	Perm
Protected Phases	
Permitted Phases	4
Actuated Green, G (s)	30.0
Effective Green, g (s)	30.0
Actuated g/C Ratio	0.22
Clearance Time (s)	5.0
Vehicle Extension (s)	3.0
Lane Grp Cap (vph)	336
v/s Ratio Prot	
v/s Ratio Perm	0.00
v/c Ratio	0.02
Uniform Delay, d1	42.2
Progression Factor	1.00
Incremental Delay, d2	0.0
Delay (s)	42.2
Level of Service	D
Approach Delay (s)	
Approach LOS	
Intersection Summary	

HCM Unsignalized Intersection Capacity Analysis

5: W Hind Dr & School Exit/Shopping Ctr Dwy

11/28/2014



Movement	EBL	EBT	EBR	WBL	WBT	WBR	NBL	NBT	NBR	SBL	SBT	SBR
Lane Configurations		↔			↔			↑↔			↔↑	
Volume (veh/h)	10	7	23	67	0	53	0	343	124	34	165	0
Sign Control		Stop			Stop			Free			Free	
Grade		0%			0%			0%			0%	
Peak Hour Factor	0.94	0.94	0.94	0.94	0.94	0.94	0.94	0.94	0.94	0.94	0.94	0.94
Hourly flow rate (vph)	11	7	24	71	0	56	0	365	132	36	176	0
Pedestrians		5									16	
Lane Width (ft)		12.0									12.0	
Walking Speed (ft/s)		4.0									4.0	
Percent Blockage		0									1	
Right turn flare (veh)												
Median type								None			None	
Median storage (veh)												
Upstream signal (ft)								274				
pX, platoon unblocked												
vC, conflicting volume	508	750	93	619	684	264	181			497		
vC1, stage 1 conf vol												
vC2, stage 2 conf vol												
vCu, unblocked vol	508	750	93	619	684	264	181			497		
tC, single (s)	*6.5	*5.5	*5.9	*6.5	6.5	*5.9	4.1			4.1		
tC, 2 stage (s)												
tF (s)	3.5	4.0	3.3	3.5	4.0	3.3	2.2			2.2		
p0 queue free %	98	98	97	83	100	93	100			97		
cM capacity (veh/h)	459	405	968	416	356	782	1387			1063		

Direction, Lane #	EB 1	WB 1	NB 1	NB 2	SB 1	SB 2
Volume Total	43	128	243	254	95	117
Volume Left	11	71	0	0	36	0
Volume Right	24	56	0	132	0	0
cSH	636	524	1700	1700	1063	1700
Volume to Capacity	0.07	0.24	0.14	0.15	0.03	0.07
Queue Length 95th (ft)	5	24	0	0	3	0
Control Delay (s)	11.1	14.1	0.0	0.0	3.4	0.0
Lane LOS	B	B			A	
Approach Delay (s)	11.1	14.1	0.0		1.5	
Approach LOS	B	B				

Intersection Summary		
Average Delay		2.9
Intersection Capacity Utilization	44.5%	ICU Level of Service A
Analysis Period (min)		15

* User Entered Value

HCM Signalized Intersection Capacity Analysis

6: Kalaniana'ole Hwy & W Hind Dr

11/28/2014



Movement	EBL	EBT	WBT	WBR	SBL	SBR
Lane Configurations	↔↔	↑↑↑	↑↑↑	↗		↗↗
Volume (vph)	557	3214	1648	51	0	379
Ideal Flow (vphpl)	1900	1900	1900	1900	1900	1900
Total Lost time (s)	5.0	5.0	5.0	5.0		5.0
Lane Util. Factor	0.97	0.91	0.91	1.00		0.88
Frbp, ped/bikes	1.00	1.00	1.00	0.96		1.00
Flpb, ped/bikes	1.00	1.00	1.00	1.00		1.00
Frt	1.00	1.00	1.00	0.85		0.85
Flt Protected	0.95	1.00	1.00	1.00		1.00
Satd. Flow (prot)	3433	5085	5085	1528		2787
Flt Permitted	0.95	1.00	1.00	1.00		1.00
Satd. Flow (perm)	3433	5085	5085	1528		2787
Peak-hour factor, PHF	0.94	0.94	0.94	0.94	0.94	0.94
Adj. Flow (vph)	593	3419	1753	54	0	403
RTOR Reduction (vph)	0	0	0	9	0	79
Lane Group Flow (vph)	593	3419	1753	45	0	324
Confl. Peds. (#/hr)				7		7
Turn Type	Prot	NA	NA	Perm		Over
Protected Phases	5	2	6			5
Permitted Phases				6		5
Actuated Green, G (s)	38.1	180.0	131.9	131.9		38.1
Effective Green, g (s)	38.1	180.0	131.9	131.9		38.1
Actuated g/C Ratio	0.21	1.00	0.73	0.73		0.21
Clearance Time (s)	5.0	5.0	5.0	5.0		5.0
Vehicle Extension (s)	3.0	3.0	3.0	3.0		3.0
Lane Grp Cap (vph)	726	5085	3726	1119		589
v/s Ratio Prot	c0.17	c0.67	0.34			0.12
v/s Ratio Perm				0.03		
v/c Ratio	0.82	0.67	0.47	0.04		0.55
Uniform Delay, d1	67.6	0.0	9.8	6.6		63.3
Progression Factor	1.00	1.00	1.00	1.00		1.00
Incremental Delay, d2	7.1	0.4	0.1	0.0		1.1
Delay (s)	74.7	0.4	9.9	6.6		64.4
Level of Service	E	A	A	A		E
Approach Delay (s)		11.3	9.8		64.4	
Approach LOS		B	A		E	

Intersection Summary			
HCM 2000 Control Delay	14.3	HCM 2000 Level of Service	B
HCM 2000 Volume to Capacity ratio	0.72		
Actuated Cycle Length (s)	180.0	Sum of lost time (s)	10.0
Intersection Capacity Utilization	75.0%	ICU Level of Service	D
Analysis Period (min)	15		

c Critical Lane Group

HCM Unsignalized Intersection Capacity Analysis

8: W Hind Dr & Project Dwy/Shopping Center Dwy

11/28/2014



Movement	EBL	EBT	EBR	WBL	WBT	WBR	NBL	NBT	NBR	SBL	SBT	SBR
Lane Configurations		↔			↔			↑↔			↔↑	
Volume (veh/h)	28	0	77	83	0	29	0	410	198	9	219	27
Sign Control		Stop			Stop			Free			Free	
Grade		0%			0%			0%			0%	
Peak Hour Factor	0.94	0.94	0.94	0.94	0.94	0.94	0.94	0.94	0.94	0.94	0.94	0.94
Hourly flow rate (vph)	30	0	82	88	0	31	0	436	211	10	233	29
Pedestrians		5										
Lane Width (ft)		12.0										
Walking Speed (ft/s)		4.0										
Percent Blockage		0										
Right turn flare (veh)												
Median type								None			None	
Median storage veh												
Upstream signal (ft)								144				
pX, platoon unblocked												
vC, conflicting volume	520	918	136	759	827	323	267			647		
vC1, stage 1 conf vol												
vC2, stage 2 conf vol												
vCu, unblocked vol	520	918	136	759	827	323	267			647		
tC, single (s)	*6.5	6.5	*5.9	*6.5	6.5	*5.9	4.1			4.1		
tC, 2 stage (s)												
tF (s)	3.5	4.0	3.3	3.5	4.0	3.3	2.2			2.2		
p0 queue free %	94	100	91	73	100	96	100			99		
cM capacity (veh/h)	481	266	920	332	301	738	1289			935		

Direction, Lane #	EB 1	WB 1	NB 1	NB 2	SB 1	SB 2
Volume Total	112	119	291	356	126	145
Volume Left	30	88	0	0	10	0
Volume Right	82	31	0	211	0	29
cSH	740	387	1700	1700	935	1700
Volume to Capacity	0.15	0.31	0.17	0.21	0.01	0.09
Queue Length 95th (ft)	13	32	0	0	1	0
Control Delay (s)	10.7	18.4	0.0	0.0	0.8	0.0
Lane LOS	B	C			A	
Approach Delay (s)	10.7	18.4	0.0		0.4	
Approach LOS	B	C				

Intersection Summary		
Average Delay		3.0
Intersection Capacity Utilization	37.4%	ICU Level of Service A
Analysis Period (min)		15

* User Entered Value

HCM Signalized Intersection Capacity Analysis

18: Waiupe Cir & Kalaniana'ole Hwy

11/28/2014



Movement	EBT	EBR	WBU	WBL	WBT	NBL	NBR
Lane Configurations	↑↑↑	↑		↓	↑↑↑	↓	↑
Volume (vph)	3714	55	42	16	1895	24	15
Ideal Flow (vphpl)	1900	1900	1900	1900	1900	1900	1900
Total Lost time (s)	5.0	5.0		5.0	5.0	5.0	5.0
Lane Util. Factor	0.91	1.00		1.00	0.91	1.00	1.00
Frbp, ped/bikes	1.00	0.97		1.00	1.00	1.00	0.98
Flpb, ped/bikes	1.00	1.00		1.00	1.00	1.00	1.00
Frt	1.00	0.85		1.00	1.00	1.00	0.85
Flt Protected	1.00	1.00		0.95	1.00	0.95	1.00
Satd. Flow (prot)	5085	1544		1770	5085	1770	1560
Flt Permitted	1.00	1.00		0.95	1.00	0.95	1.00
Satd. Flow (perm)	5085	1544		1770	5085	1770	1560
Peak-hour factor, PHF	0.94	0.94	0.94	0.94	0.94	0.94	0.94
Adj. Flow (vph)	3951	59	45	17	2016	26	16
RTOR Reduction (vph)	0	6	0	0	0	0	15
Lane Group Flow (vph)	3951	53	0	62	2016	26	1
Confl. Peds. (#/hr)		1					1
Turn Type	NA	Perm	Prot	Prot	NA	Prot	Perm
Protected Phases	2		1	1	6	8	
Permitted Phases		2					8
Actuated Green, G (s)	132.9	132.9		9.5	147.4	6.6	6.6
Effective Green, g (s)	132.9	132.9		9.5	147.4	6.6	6.6
Actuated g/C Ratio	0.81	0.81		0.06	0.90	0.04	0.04
Clearance Time (s)	5.0	5.0		5.0	5.0	5.0	5.0
Vehicle Extension (s)	3.0	3.0		3.0	3.0	3.0	3.0
Lane Grp Cap (vph)	4120	1251		102	4570	71	62
v/s Ratio Prot	c0.78			c0.04	0.40	c0.01	
v/s Ratio Perm		0.03					0.00
v/c Ratio	0.96	0.04		0.61	0.44	0.37	0.01
Uniform Delay, d1	13.2	3.1		75.4	1.4	76.7	75.6
Progression Factor	1.00	1.00		1.00	1.00	1.00	1.00
Incremental Delay, d2	6.9	0.0		9.8	0.1	3.2	0.1
Delay (s)	20.1	3.1		85.3	1.5	79.8	75.6
Level of Service	C	A		F	A	E	E
Approach Delay (s)	19.8				4.0	78.2	
Approach LOS	B				A	E	

Intersection Summary

HCM 2000 Control Delay	14.9	HCM 2000 Level of Service	B
HCM 2000 Volume to Capacity ratio	0.91		
Actuated Cycle Length (s)	164.0	Sum of lost time (s)	15.0
Intersection Capacity Utilization	83.8%	ICU Level of Service	E
Analysis Period (min)	15		

c Critical Lane Group

HCM Unsignalized Intersection Capacity Analysis

19: W Hind Dr & Makalena St

11/28/2014



Movement	EBL	EBT	EBR	WBL	WBT	WBR	NBL	NBT	NBR	SBL	SBT	SBR
Lane Configurations					↕			↕			↕	
Volume (veh/h)	0	0	0	5	0	3	23	344	24	0	182	6
Sign Control		Stop			Stop			Free			Free	
Grade		0%			0%			0%			0%	
Peak Hour Factor	0.96	0.96	0.96	0.96	0.96	0.96	0.96	0.96	0.96	0.96	0.96	0.96
Hourly flow rate (vph)	0	0	0	5	0	3	24	358	25	0	190	6
Pedestrians		1			11						3	
Lane Width (ft)		0.0			12.0						12.0	
Walking Speed (ft/s)		4.0			4.0						4.0	
Percent Blockage		0			1						0	
Right turn flare (veh)												
Median type								None			None	
Median storage veh												
Upstream signal (ft)								568				
pX, platoon unblocked												
vC, conflicting volume	427	636	194	622	627	206	197			394		
vC1, stage 1 conf vol												
vC2, stage 2 conf vol												
vCu, unblocked vol	427	636	194	622	627	206	197			394		
tC, single (s)	7.5	6.5	6.9	*6.5	6.5	*5.9	4.1			4.1		
tC, 2 stage (s)												
tF (s)	3.5	4.0	3.3	3.5	4.0	3.3	2.2			2.2		
p0 queue free %	100	100	100	99	100	100	98			100		
cM capacity (veh/h)	498	384	815	431	388	840	1373			1150		

Direction, Lane #	WB 1	NB 1	NB 2	SB 1
Volume Total	8	203	204	196
Volume Left	5	24	0	0
Volume Right	3	0	25	6
cSH	527	1373	1700	1150
Volume to Capacity	0.02	0.02	0.12	0.00
Queue Length 95th (ft)	1	1	0	0
Control Delay (s)	11.9	1.0	0.0	0.0
Lane LOS	B	A		
Approach Delay (s)	11.9	0.5		0.0
Approach LOS	B			

Intersection Summary			
Average Delay		0.5	
Intersection Capacity Utilization		36.1%	ICU Level of Service
Analysis Period (min)		15	A

* User Entered Value

HCM Unsignalized Intersection Capacity Analysis

20: W Hind Dr & School Dwy/Nenue St

11/28/2014



Movement	EBL	EBT	EBR	WBL	WBT	WBR	NBL	NBT	NBR	SBL	SBT	SBR
Lane Configurations		↔			↔			↔			↔	
Volume (veh/h)	21	8	18	30	0	7	25	294	42	9	153	7
Sign Control		Stop			Stop			Free			Free	
Grade		0%			0%			0%			0%	
Peak Hour Factor	0.91	0.91	0.91	0.91	0.91	0.91	0.91	0.91	0.91	0.91	0.91	0.91
Hourly flow rate (vph)	23	9	20	33	0	8	27	323	46	10	168	8
Pedestrians		5										
Lane Width (ft)		12.0										
Walking Speed (ft/s)		4.0										
Percent Blockage		0										
Right turn flare (veh)												
Median type								None			None	
Median storage veh												
Upstream signal (ft)								854				
pX, platoon unblocked												
vC, conflicting volume	606	621	177	617	602	346	181			369		
vC1, stage 1 conf vol												
vC2, stage 2 conf vol												
vCu, unblocked vol	606	621	177	617	602	346	181			369		
tC, single (s)	*6.1	*5.5	*5.2	*6.1	6.5	*5.2	4.1			4.1		
tC, 2 stage (s)												
tF (s)	3.5	4.0	3.3	3.5	4.0	3.3	2.2			2.2		
p0 queue free %	95	98	98	93	100	99	98			99		
cM capacity (veh/h)	467	466	907	451	400	769	1389			1189		

Direction, Lane #	EB 1	WB 1	NB 1	SB 1
Volume Total	52	41	397	186
Volume Left	23	33	27	10
Volume Right	20	8	46	8
cSH	573	489	1389	1189
Volume to Capacity	0.09	0.08	0.02	0.01
Queue Length 95th (ft)	7	7	2	1
Control Delay (s)	11.9	13.0	0.7	0.5
Lane LOS	B	B	A	A
Approach Delay (s)	11.9	13.0	0.7	0.5
Approach LOS	B	B		

Intersection Summary			
Average Delay		2.3	
Intersection Capacity Utilization	36.7%		ICU Level of Service A
Analysis Period (min)		15	

* User Entered Value

APPENDIX G

CAPACITY ANALYSIS CALCULATIONS
PROJECTED YEAR 2015 PEAK HOUR TRAFFIC ANALYSIS
WITH ALTERNATIVE 3

HCM Signalized Intersection Capacity Analysis

4: Church Dwy/Nenu St & Kalaniana'ole Hwy

11/28/2014



Movement	EBL	EBT	EBR	WBL	WBT	WBR	NBL	NBT	NBR	SBL	SBT	SBR
Lane Configurations		↑↓			↑↑↑			↕			↑	↗
Volume (vph)	0	1001	18	0	4418	145	0	4	1	78	2	54
Ideal Flow (vphpl)	1900	1900	1900	1900	1900	1900	1900	1900	1900	1900	1900	1900
Total Lost time (s)		5.0			5.0			5.0			5.0	5.0
Lane Util. Factor		0.95			0.86			1.00			1.00	1.00
Frb, ped/bikes		1.00			1.00			1.00			1.00	0.93
Flpb, ped/bikes		1.00			1.00			1.00			1.00	1.00
Frt		1.00			1.00			0.97			1.00	0.85
Flt Protected		1.00			1.00			1.00			0.95	1.00
Satd. Flow (prot)		3530			6377			1812			1776	1476
Flt Permitted		1.00			1.00			1.00			0.73	1.00
Satd. Flow (perm)		3530			6377			1812			1356	1476
Peak-hour factor, PHF	0.96	0.96	0.96	0.96	0.96	0.96	0.96	0.96	0.96	0.96	0.96	0.96
Adj. Flow (vph)	0	1043	19	0	4602	151	0	4	1	81	2	56
RTOR Reduction (vph)	0	1	0	0	2	0	0	1	0	0	0	8
Lane Group Flow (vph)	0	1061	0	0	4751	0	0	4	0	0	83	48
Confl. Peds. (#/hr)												13
Turn Type		NA			NA			NA		Perm	NA	Perm
Protected Phases		2			6			8			4	
Permitted Phases							8			4		4
Actuated Green, G (s)		204.1			204.1			19.2			19.2	19.2
Effective Green, g (s)		204.1			204.1			19.2			19.2	19.2
Actuated g/C Ratio		0.87			0.87			0.08			0.08	0.08
Clearance Time (s)		5.0			5.0			5.0			5.0	5.0
Vehicle Extension (s)		3.0			3.0			3.0			3.0	3.0
Lane Grp Cap (vph)		3088			5578			149			111	121
v/s Ratio Prot		0.30			c0.75			0.00				
v/s Ratio Perm											c0.06	0.03
v/c Ratio		0.34			0.85			0.03			0.75	0.39
Uniform Delay, d1		2.6			7.2			98.5			104.7	101.5
Progression Factor		1.00			1.00			1.00			1.00	1.00
Incremental Delay, d2		0.1			1.4			0.1			23.7	2.1
Delay (s)		2.7			8.6			98.5			128.4	103.7
Level of Service		A			A			F			F	F
Approach Delay (s)		2.7			8.6			98.5			118.4	
Approach LOS		A			A			F			F	

Intersection Summary

HCM 2000 Control Delay	10.1	HCM 2000 Level of Service	B
HCM 2000 Volume to Capacity ratio	0.84		
Actuated Cycle Length (s)	233.3	Sum of lost time (s)	10.0
Intersection Capacity Utilization	90.0%	ICU Level of Service	E
Analysis Period (min)	15		

c Critical Lane Group

HCM Unsignalized Intersection Capacity Analysis
 5: W Hind Dr & School Exit/Shopping Center Dwy

11/28/2014



Movement	EBL	EBT	EBR	WBL	WBT	WBR	NBL	NBT	NBR	SBL	SBT	SBR
Lane Configurations		↔			↔			↑↔			↔↑	
Volume (veh/h)	8	7	17	63	0	37	0	181	10	42	327	0
Sign Control		Stop			Stop			Free			Free	
Grade		0%			0%			0%			0%	
Peak Hour Factor	0.87	0.87	0.87	0.87	0.87	0.87	0.87	0.87	0.87	0.87	0.87	0.87
Hourly flow rate (vph)	9	8	20	72	0	43	0	208	11	48	376	0
Pedestrians											11	
Lane Width (ft)											12.0	
Walking Speed (ft/s)											4.0	
Percent Blockage											1	
Right turn flare (veh)												
Median type								None			None	
Median storage veh												
Upstream signal (ft)								274				
pX, platoon unblocked												
vC, conflicting volume	630	692	188	522	686	121	376			220		
vC1, stage 1 conf vol												
vC2, stage 2 conf vol												
vCu, unblocked vol	630	692	188	522	686	121	376			220		
tC, single (s)	*6.5	*5.5	*5.9	*6.5	6.5	*5.9	4.1			4.1		
tC, 2 stage (s)												
tF (s)	3.5	4.0	3.3	3.5	4.0	3.3	2.2			2.2		
p0 queue free %	98	98	98	85	100	95	100			96		
cM capacity (veh/h)	404	431	868	477	355	931	1179			1347		

Direction, Lane #	EB 1	WB 1	NB 1	NB 2	SB 1	SB 2
Volume Total	37	115	139	81	174	251
Volume Left	9	72	0	0	48	0
Volume Right	20	43	0	11	0	0
cSH	575	582	1700	1700	1347	1700
Volume to Capacity	0.06	0.20	0.08	0.05	0.04	0.15
Queue Length 95th (ft)	5	18	0	0	3	0
Control Delay (s)	11.7	12.7	0.0	0.0	2.4	0.0
Lane LOS	B	B			A	
Approach Delay (s)	11.7	12.7	0.0		1.0	
Approach LOS	B	B				

Intersection Summary		
Average Delay		2.9
Intersection Capacity Utilization	38.6%	ICU Level of Service A
Analysis Period (min)		15

* User Entered Value

HCM Signalized Intersection Capacity Analysis

6: Kalaniana'ole Hwy & W Hind Dr

11/28/2014



Movement	EBL	EBT	WBT	WBR	SBL	SBR
Lane Configurations						
Volume (vph)	208	1013	4401	71	0	454
Ideal Flow (vphpl)	1900	1900	1900	1900	1900	1900
Total Lost time (s)	5.0	5.0	5.0	5.0		5.0
Lane Util. Factor	0.97	0.95	0.86	1.00		0.88
Frb, ped/bikes	1.00	1.00	1.00	0.98		1.00
Fipb, ped/bikes	1.00	1.00	1.00	1.00		1.00
Frt	1.00	1.00	1.00	0.85		0.85
Flt Protected	0.95	1.00	1.00	1.00		1.00
Satd. Flow (prot)	3433	3539	6408	1557		2787
Flt Permitted	0.95	1.00	1.00	1.00		1.00
Satd. Flow (perm)	3433	3539	6408	1557		2787
Peak-hour factor, PHF	0.95	0.95	0.95	0.95	0.95	0.95
Adj. Flow (vph)	219	1066	4633	75	0	478
RTOR Reduction (vph)	0	0	0	5	0	84
Lane Group Flow (vph)	219	1066	4633	70	0	394
Confl. Peds. (#/hr)				1		1
Turn Type	Prot	NA	NA	Perm		Over
Protected Phases	5	2	6			5
Permitted Phases				6		5
Actuated Green, G (s)	36.9	235.0	188.1	188.1		36.9
Effective Green, g (s)	36.9	235.0	188.1	188.1		36.9
Actuated g/C Ratio	0.16	1.00	0.80	0.80		0.16
Clearance Time (s)	5.0	5.0	5.0	5.0		5.0
Vehicle Extension (s)	3.0	3.0	3.0	3.0		3.0
Lane Grp Cap (vph)	539	3539	5129	1246		437
v/s Ratio Prot	0.06	0.30	c0.72			c0.14
v/s Ratio Perm				0.04		
v/c Ratio	0.41	0.30	0.90	0.06		0.90
Uniform Delay, d1	89.2	0.0	16.9	4.9		97.3
Progression Factor	1.00	1.00	1.00	1.00		1.00
Incremental Delay, d2	0.5	0.0	2.6	0.0		21.3
Delay (s)	89.7	0.0	19.5	4.9		118.5
Level of Service	F	A	B	A		F
Approach Delay (s)		15.3	19.3		118.5	
Approach LOS		B	B		F	

Intersection Summary

HCM 2000 Control Delay	25.8	HCM 2000 Level of Service	C
HCM 2000 Volume to Capacity ratio	0.90		
Actuated Cycle Length (s)	235.0	Sum of lost time (s)	10.0
Intersection Capacity Utilization	88.1%	ICU Level of Service	E
Analysis Period (min)	15		

c Critical Lane Group

HCM Unsignalized Intersection Capacity Analysis
 8: W Hind Dr & Church Dwy/Shopping Center Dwy

11/28/2014



Movement	EBL	EBT	EBR	WBL	WBT	WBR	NBL	NBT	NBR	SBL	SBT	SBR
Lane Configurations		↕			↕			↕			↕	
Volume (veh/h)	2	0	23	40	0	18	0	172	107	6	391	9
Sign Control		Stop			Stop			Free			Free	
Grade		0%			0%			0%			0%	
Peak Hour Factor	0.93	0.93	0.93	0.93	0.93	0.93	0.93	0.93	0.93	0.93	0.93	0.93
Hourly flow rate (vph)	2	0	25	43	0	19	0	185	115	6	420	10
Pedestrians		4										
Lane Width (ft)		12.0										
Walking Speed (ft/s)		4.0										
Percent Blockage		0										
Right turn flare (veh)												
Median type								None			None	
Median storage veh												
Upstream signal (ft)								144				
pX, platoon unblocked												
vC, conflicting volume	554	742	219	490	689	150	434			300		
vC1, stage 1 conf vol												
vC2, stage 2 conf vol												
vCu, unblocked vol	554	742	219	490	689	150	434			300		
tC, single (s)	*6.5	6.5	*5.9	*6.5	6.5	*5.9	4.1			4.1		
tC, 2 stage (s)												
tF (s)	3.5	4.0	3.3	3.5	4.0	3.3	2.2			2.2		
p0 queue free %	100	100	97	92	100	98	100			99		
cM capacity (veh/h)	472	339	834	512	364	908	1118			1258		

Direction, Lane #	EB 1	WB 1	NB 1	NB 2	SB 1	SB 2
Volume Total	27	62	123	177	217	220
Volume Left	2	43	0	0	6	0
Volume Right	25	19	0	115	0	10
cSH	785	592	1700	1700	1258	1700
Volume to Capacity	0.03	0.11	0.07	0.10	0.01	0.13
Queue Length 95th (ft)	3	9	0	0	0	0
Control Delay (s)	9.7	11.8	0.0	0.0	0.3	0.0
Lane LOS	A	B			A	
Approach Delay (s)	9.7	11.8	0.0		0.1	
Approach LOS	A	B				

Intersection Summary		
Average Delay		1.3
Intersection Capacity Utilization	32.0%	ICU Level of Service A
Analysis Period (min)		15

* User Entered Value

HCM Signalized Intersection Capacity Analysis
 18: Wailupe Cir & Kalaniana'ole Hwy

11/28/2014



Movement	EBT	EBR	WBU	WBL	WBT	NBL	NBR
Lane Configurations	↑↑	↗		↘	↑↑↑	↖	↗
Volume (vph)	1210	15	3	9	4805	56	8
Ideal Flow (vphpl)	1900	1900	1900	1900	1900	1900	1900
Total Lost time (s)	5.0	5.0		5.0	5.0	5.0	5.0
Lane Util. Factor	0.95	1.00		1.00	0.86	1.00	1.00
Frbp, ped/bikes	1.00	0.97		1.00	1.00	1.00	1.00
Flpb, ped/bikes	1.00	1.00		1.00	1.00	1.00	1.00
Frt	1.00	0.85		1.00	1.00	1.00	0.85
Flt Protected	1.00	1.00		0.95	1.00	0.95	1.00
Satd. Flow (prot)	3539	1528		1770	6408	1770	1583
Flt Permitted	1.00	1.00		0.95	1.00	0.95	1.00
Satd. Flow (perm)	3539	1528		1770	6408	1770	1583
Peak-hour factor, PHF	0.94	0.94	0.94	0.94	0.94	0.94	0.94
Adj. Flow (vph)	1287	16	3	10	5112	60	9
RTOR Reduction (vph)	0	2	0	0	0	0	9
Lane Group Flow (vph)	1287	14	0	13	5112	60	0
Confl. Peds. (#/hr)		2					
Turn Type	NA	Perm	Prot	Prot	NA	Prot	Perm
Protected Phases	2		1	1	6	8	
Permitted Phases		2					8
Actuated Green, G (s)	207.5	207.5		3.6	216.1	12.9	12.9
Effective Green, g (s)	207.5	207.5		3.6	216.1	12.9	12.9
Actuated g/C Ratio	0.87	0.87		0.02	0.90	0.05	0.05
Clearance Time (s)	5.0	5.0		5.0	5.0	5.0	5.0
Vehicle Extension (s)	3.0	3.0		3.0	3.0	3.0	3.0
Lane Grp Cap (vph)	3072	1326		26	5794	95	85
v/s Ratio Prot	0.36			0.01	c0.80	c0.03	
v/s Ratio Perm		0.01					0.00
v/c Ratio	0.42	0.01		0.50	0.88	0.63	0.01
Uniform Delay, d1	3.3	2.1		116.8	5.4	110.7	107.0
Progression Factor	1.00	1.00		1.00	1.00	1.00	1.00
Incremental Delay, d2	0.1	0.0		14.3	1.8	12.9	0.0
Delay (s)	3.4	2.1		131.1	7.2	123.6	107.0
Level of Service	A	A		F	A	F	F
Approach Delay (s)	3.3				7.6	121.5	
Approach LOS	A				A	F	

Intersection Summary

HCM 2000 Control Delay	7.9	HCM 2000 Level of Service	A
HCM 2000 Volume to Capacity ratio	0.89		
Actuated Cycle Length (s)	239.0	Sum of lost time (s)	15.0
Intersection Capacity Utilization	81.3%	ICU Level of Service	D
Analysis Period (min)	15		

c Critical Lane Group

HCM 2010 Roundabout
 19: W Hind Drive & Makalena St

11/28/2014

Intersection				
Intersection Delay, s/veh	6.9			
Intersection LOS	A			
Approach	EB	WB	NB	SB
Entry Lanes	0	1	1	1
Conflicting Circle Lanes	1	1	1	1
Adj Approach Flow, veh/h	0	9	249	412
Demand Flow Rate, veh/h	0	9	253	420
Vehicles Circulating, veh/h	424	245	0	83
Vehicles Exiting, veh/h	79	8	424	171
Follow-Up Headway, s	3.186	3.186	3.186	3.186
Ped Vol Crossing Leg, #/h	6	18	0	2
Ped Cap Adj	1.000	0.998	1.000	1.000
Approach Delay, s/veh	0.0	4.2	5.3	7.9
Approach LOS	-	A	A	A
Lane	Left	Left	Left	Left
Designated Moves	LTR	LTR	LTR	LTR
Assumed Moves	LTR	LTR	LTR	LTR
RT Channelized				
Lane Util	1.000	1.000	1.000	1.000
Critical Headway, s	5.193	5.193	5.193	5.193
Entry Flow, veh/h	9	253	420	
Cap Entry Lane, veh/h	884	1130	1040	
Entry HV Adj Factor	1.000	0.982	0.981	
Flow Entry, veh/h	9	249	412	
Cap Entry, veh/h	882	1110	1020	
V/C Ratio	0.010	0.224	0.404	
Control Delay, s/veh	4.2	5.3	7.9	
LOS	A	A	A	
95th %tile Queue, veh	0	1	2	

HCM Unsignalized Intersection Capacity Analysis

20: W Hind Drive & School Dwy/Nenu St

11/28/2014



Movement	EBL	EBT	EBR	WBL	WBT	WBR	NBL	NBT	NBR	SBL	SBT	SBR
Lane Configurations		↕			↕			↕			↕	
Volume (veh/h)	5	2	23	8	3	3	33	100	17	11	336	14
Sign Control		Stop			Stop			Free			Free	
Grade		0%			0%			0%			0%	
Peak Hour Factor	0.93	0.93	0.93	0.93	0.93	0.93	0.93	0.93	0.93	0.93	0.93	0.93
Hourly flow rate (vph)	5	2	25	9	3	3	35	108	18	12	361	15
Pedestrians		3										
Lane Width (ft)		12.0										
Walking Speed (ft/s)		4.0										
Percent Blockage		0										
Right turn flare (veh)												
Median type								None			None	
Median storage (veh)												
Upstream signal (ft)												
pX, platoon unblocked												
vC, conflicting volume	588	592	372	606	591	117	379			126		
vC1, stage 1 conf vol												
vC2, stage 2 conf vol												
vCu, unblocked vol	588	592	372	606	591	117	379			126		
tC, single (s)	*6.1	*5.5	*5.2	*6.1	*5.5	*5.2	4.1			4.1		
tC, 2 stage (s)												
tF (s)	3.5	4.0	3.3	3.5	4.0	3.3	2.2			2.2		
p0 queue free %	99	100	97	98	99	100	97			99		
cM capacity (veh/h)	476	475	747	454	476	967	1176			1461		

Direction, Lane #	EB 1	WB 1	NB 1	SB 1
Volume Total	32	15	161	388
Volume Left	5	9	35	12
Volume Right	25	3	18	15
cSH	659	518	1176	1461
Volume to Capacity	0.05	0.03	0.03	0.01
Queue Length 95th (ft)	4	2	2	1
Control Delay (s)	10.7	12.2	2.0	0.3
Lane LOS	B	B	A	A
Approach Delay (s)	10.7	12.2	2.0	0.3
Approach LOS	B	B		

Intersection Summary			
Average Delay		1.6	
Intersection Capacity Utilization		32.9%	ICU Level of Service A
Analysis Period (min)		15	

* User Entered Value

HCM Signalized Intersection Capacity Analysis

4: Church Dwy/Nenuue St & Kalaniana'ole Hwy

11/28/2014



Movement	EBU	EBL	EBT	EBR	WBL	WBT	WBR	NBL	NBT	NBR	SBL	SBT
Lane Configurations		↔	↑↑↑		↔	↑↑↑			↕			↔
Volume (vph)	7	11	3134	2	7	1621	97	0	0	0	238	1
Ideal Flow (vphpl)	1900	1900	1900	1900	1900	1900	1900	1900	1900	1900	1900	1900
Total Lost time (s)		5.0	5.0		5.0	5.0						5.0
Lane Util. Factor		1.00	0.91		1.00	0.91						1.00
Frbp, ped/bikes		1.00	1.00		1.00	1.00						1.00
Flpb, ped/bikes		1.00	1.00		1.00	1.00						1.00
Frt		1.00	1.00		1.00	0.99						1.00
Flt Protected		0.95	1.00		0.95	1.00						0.95
Satd. Flow (prot)		1770	5085		1770	5033						1774
Flt Permitted		0.95	1.00		0.95	1.00						0.73
Satd. Flow (perm)		1770	5085		1770	5033						1355
Peak-hour factor, PHF	0.95	0.95	0.95	0.95	0.95	0.95	0.95	0.95	0.95	0.95	0.95	0.95
Adj. Flow (vph)	7	12	3299	2	7	1706	102	0	0	0	251	1
RTOR Reduction (vph)	0	0	0	0	0	3	0	0	0	0	0	0
Lane Group Flow (vph)	0	19	3301	0	7	1805	0	0	0	0	0	252
Confl. Peds. (#/hr)							3					
Turn Type	Prot	Prot	NA		Prot	NA					Perm	NA
Protected Phases	5	5	2		1	6			8			4
Permitted Phases								8				4
Actuated Green, G (s)		3.2	91.1		1.3	89.2						30.0
Effective Green, g (s)		3.2	91.1		1.3	89.2						30.0
Actuated g/C Ratio		0.02	0.66		0.01	0.65						0.22
Clearance Time (s)		5.0	5.0		5.0	5.0						5.0
Vehicle Extension (s)		3.0	3.0		3.0	3.0						3.0
Lane Grp Cap (vph)		41	3371		16	3267						295
v/s Ratio Prot		c0.01	c0.65		0.00	0.36						
v/s Ratio Perm												c0.19
v/c Ratio		0.46	0.98		0.44	0.55						0.85
Uniform Delay, d1		66.3	22.2		67.7	13.2						51.6
Progression Factor		1.00	1.00		1.00	1.00						1.00
Incremental Delay, d2		8.1	11.0		18.0	0.2						20.7
Delay (s)		74.3	33.2		85.7	13.4						72.3
Level of Service		E	C		F	B						E
Approach Delay (s)			33.5			13.7			0.0			68.8
Approach LOS			C			B			A			E

Intersection Summary

HCM 2000 Control Delay	28.7	HCM 2000 Level of Service	C
HCM 2000 Volume to Capacity ratio	0.95		
Actuated Cycle Length (s)	137.4	Sum of lost time (s)	15.0
Intersection Capacity Utilization	82.2%	ICU Level of Service	E
Analysis Period (min)	15		

c Critical Lane Group

HCM Signalized Intersection Capacity Analysis
 4: Church Dwy/Nenu St & Kalaniana'ole Hwy

11/28/2014



Movement	SBR
Lane Configurations	7
Volume (vph)	31
Ideal Flow (vphpl)	1900
Total Lost time (s)	5.0
Lane Util. Factor	1.00
Frb, ped/bikes	0.98
Fpb, ped/bikes	1.00
Frt	0.85
Flt Protected	1.00
Satd. Flow (prot)	1544
Flt Permitted	1.00
Satd. Flow (perm)	1544
Peak-hour factor, PHF	0.95
Adj. Flow (vph)	33
RTOR Reduction (vph)	26
Lane Group Flow (vph)	7
Confl. Peds. (#/hr)	5
Turn Type	Perm
Protected Phases	
Permitted Phases	4
Actuated Green, G (s)	30.0
Effective Green, g (s)	30.0
Actuated g/C Ratio	0.22
Clearance Time (s)	5.0
Vehicle Extension (s)	3.0
Lane Grp Cap (vph)	337
v/s Ratio Prot	
v/s Ratio Perm	0.00
v/c Ratio	0.02
Uniform Delay, d1	42.2
Progression Factor	1.00
Incremental Delay, d2	0.0
Delay (s)	42.2
Level of Service	D
Approach Delay (s)	
Approach LOS	
Intersection Summary	

HCM Unsignalized Intersection Capacity Analysis

5: W Hind Dr & School Exit/Shopping Center Dwy

11/28/2014



Movement	EBL	EBT	EBR	WBL	WBT	WBR	NBL	NBT	NBR	SBL	SBT	SBR
Lane Configurations		↔			↔			↑↔			↔↑	
Volume (veh/h)	10	7	23	67	0	53	0	410	124	34	205	0
Sign Control		Stop			Stop			Free			Free	
Grade		0%			0%			0%			0%	
Peak Hour Factor	0.94	0.94	0.94	0.94	0.94	0.94	0.94	0.94	0.94	0.94	0.94	0.94
Hourly flow rate (vph)	11	7	24	71	0	56	0	436	132	36	218	0
Pedestrians											16	
Lane Width (ft)											12.0	
Walking Speed (ft/s)											4.0	
Percent Blockage											1	
Right turn flare (veh)												
Median type								None			None	
Median storage veh												
Upstream signal (ft)								274				
pX, platoon unblocked												
vC, conflicting volume	581	859	109	712	793	300	218			568		
vC1, stage 1 conf vol												
vC2, stage 2 conf vol												
vCu, unblocked vol	581	859	109	712	793	300	218			568		
tC, single (s)	*6.5	*5.5	*5.9	*6.5	6.5	*5.9	4.1			4.1		
tC, 2 stage (s)												
tF (s)	3.5	4.0	3.3	3.5	4.0	3.3	2.2			2.2		
p0 queue free %	97	98	97	81	100	92	100			96		
cM capacity (veh/h)	417	362	953	366	308	749	1349			1000		

Direction, Lane #	EB 1	WB 1	NB 1	NB 2	SB 1	SB 2
Volume Total	43	128	291	277	109	145
Volume Left	11	71	0	0	36	0
Volume Right	24	56	0	132	0	0
cSH	593	473	1700	1700	1000	1700
Volume to Capacity	0.07	0.27	0.17	0.16	0.04	0.09
Queue Length 95th (ft)	6	27	0	0	3	0
Control Delay (s)	11.5	15.4	0.0	0.0	3.1	0.0
Lane LOS	B	C			A	
Approach Delay (s)	11.5	15.4	0.0		1.3	
Approach LOS	B	C				

Intersection Summary	
Average Delay	2.8
Intersection Capacity Utilization	46.3%
ICU Level of Service	A
Analysis Period (min)	15

* User Entered Value

HCM Signalized Intersection Capacity Analysis

6: Kalaniana'ole Hwy & W Hind Dr

11/28/2014



Movement	EBL	EBT	WBT	WBR	SBL	SBR
Lane Configurations	↔↔	↑↑↑	↑↑↑	↗		↗↗
Volume (vph)	624	3147	1608	51	0	379
Ideal Flow (vphpl)	1900	1900	1900	1900	1900	1900
Total Lost time (s)	5.0	5.0	5.0	5.0		5.0
Lane Util. Factor	0.97	0.91	0.91	1.00		0.88
Frbp, ped/bikes	1.00	1.00	1.00	0.96		1.00
Flpb, ped/bikes	1.00	1.00	1.00	1.00		1.00
Frt	1.00	1.00	1.00	0.85		0.85
Flt Protected	0.95	1.00	1.00	1.00		1.00
Satd. Flow (prot)	3433	5085	5085	1528		2787
Flt Permitted	0.95	1.00	1.00	1.00		1.00
Satd. Flow (perm)	3433	5085	5085	1528		2787
Peak-hour factor, PHF	0.94	0.94	0.94	0.94	0.94	0.94
Adj. Flow (vph)	664	3348	1711	54	0	403
RTOR Reduction (vph)	0	0	0	9	0	77
Lane Group Flow (vph)	664	3348	1711	45	0	326
Confl. Peds. (#/hr)				7		7
Turn Type	Prot	NA	NA	Perm		Over
Protected Phases	5	2	6			5
Permitted Phases				6		5
Actuated Green, G (s)	42.1	180.0	127.9	127.9		42.1
Effective Green, g (s)	42.1	180.0	127.9	127.9		42.1
Actuated g/C Ratio	0.23	1.00	0.71	0.71		0.23
Clearance Time (s)	5.0	5.0	5.0	5.0		5.0
Vehicle Extension (s)	3.0	3.0	3.0	3.0		3.0
Lane Grp Cap (vph)	802	5085	3613	1085		651
v/s Ratio Prot	c0.19	c0.66	0.34			0.12
v/s Ratio Perm				0.03		
v/c Ratio	0.83	0.66	0.47	0.04		0.50
Uniform Delay, d1	65.5	0.0	11.4	7.8		59.8
Progression Factor	1.00	1.00	1.00	1.00		1.00
Incremental Delay, d2	7.0	0.3	0.1	0.0		0.6
Delay (s)	72.6	0.3	11.5	7.8		60.5
Level of Service	E	A	B	A		E
Approach Delay (s)		12.3	11.3		60.5	
Approach LOS		B	B		E	

Intersection Summary

HCM 2000 Control Delay	15.1	HCM 2000 Level of Service	B
HCM 2000 Volume to Capacity ratio	0.72		
Actuated Cycle Length (s)	180.0	Sum of lost time (s)	10.0
Intersection Capacity Utilization	73.7%	ICU Level of Service	D
Analysis Period (min)	15		

c Critical Lane Group

HCM Unsignalized Intersection Capacity Analysis
 8: W Hind Dr & Church Dwy/Shopping Center Dwy

11/28/2014



Movement	EBL	EBT	EBR	WBL	WBT	WBR	NBL	NBT	NBR	SBL	SBT	SBR
Lane Configurations		↔			↔			↑↔			↔↑	
Volume (veh/h)	28	0	77	83	0	29	0	477	198	9	219	67
Sign Control		Stop			Stop			Free			Free	
Grade		0%			0%			0%			0%	
Peak Hour Factor	0.94	0.94	0.94	0.94	0.94	0.94	0.94	0.94	0.94	0.94	0.94	0.94
Hourly flow rate (vph)	30	0	82	88	0	31	0	507	211	10	233	71
Pedestrians		5										
Lane Width (ft)		12.0										
Walking Speed (ft/s)		4.0										
Percent Blockage		0										
Right turn flare (veh)												
Median type								None			None	
Median storage veh												
Upstream signal (ft)								144				
pX, platoon unblocked												
vC, conflicting volume	577	1011	157	830	941	359	309			718		
vC1, stage 1 conf vol												
vC2, stage 2 conf vol												
vCu, unblocked vol	577	1011	157	830	941	359	309			718		
tC, single (s)	7.5	6.5	6.9	*6.5	6.5	*5.9	4.1			4.1		
tC, 2 stage (s)												
tF (s)	3.5	4.0	3.3	3.5	4.0	3.3	2.2			2.2		
p0 queue free %	92	100	90	70	100	96	100			99		
cM capacity (veh/h)	376	235	857	298	258	707	1243			879		

Direction, Lane #	EB 1	WB 1	NB 1	NB 2	SB 1	SB 2
Volume Total	112	119	338	380	126	188
Volume Left	30	88	0	0	10	0
Volume Right	82	31	0	211	0	71
cSH	639	351	1700	1700	879	1700
Volume to Capacity	0.17	0.34	0.20	0.22	0.01	0.11
Queue Length 95th (ft)	16	37	0	0	1	0
Control Delay (s)	11.8	20.5	0.0	0.0	0.8	0.0
Lane LOS	B	C			A	
Approach Delay (s)	11.8	20.5	0.0		0.3	
Approach LOS	B	C				

Intersection Summary		
Average Delay		3.1
Intersection Capacity Utilization	39.2%	ICU Level of Service A
Analysis Period (min)		15

* User Entered Value

HCM Signalized Intersection Capacity Analysis

18: Waiupe Cir & Kalaniana'ole Hwy

11/28/2014



Movement	EBT	EBR	WBU	WBL	WBT	NBL	NBR
Lane Configurations	↑↑↑	↑		↔	↑↑↑	↑	↑
Volume (vph)	3714	55	42	16	1895	24	15
Ideal Flow (vphpl)	1900	1900	1900	1900	1900	1900	1900
Total Lost time (s)	5.0	5.0		5.0	5.0	5.0	5.0
Lane Util. Factor	0.91	1.00		1.00	0.91	1.00	1.00
Frbp, ped/bikes	1.00	0.97		1.00	1.00	1.00	0.98
Fipb, ped/bikes	1.00	1.00		1.00	1.00	1.00	1.00
Frt	1.00	0.85		1.00	1.00	1.00	0.85
Fit Protected	1.00	1.00		0.95	1.00	0.95	1.00
Satd. Flow (prot)	5085	1544		1770	5085	1770	1560
Fit Permitted	1.00	1.00		0.95	1.00	0.95	1.00
Satd. Flow (perm)	5085	1544		1770	5085	1770	1560
Peak-hour factor, PHF	0.94	0.94	0.94	0.94	0.94	0.94	0.94
Adj. Flow (vph)	3951	59	45	17	2016	26	16
RTOR Reduction (vph)	0	6	0	0	0	0	15
Lane Group Flow (vph)	3951	53	0	62	2016	26	1
Confl. Peds. (#/hr)		1					1
Turn Type	NA	Perm	Prot	Prot	NA	Prot	Perm
Protected Phases	2		1	1	6	8	
Permitted Phases		2					8
Actuated Green, G (s)	132.9	132.9		9.5	147.4	6.6	6.6
Effective Green, g (s)	132.9	132.9		9.5	147.4	6.6	6.6
Actuated g/C Ratio	0.81	0.81		0.06	0.90	0.04	0.04
Clearance Time (s)	5.0	5.0		5.0	5.0	5.0	5.0
Vehicle Extension (s)	3.0	3.0		3.0	3.0	3.0	3.0
Lane Grp Cap (vph)	4120	1251		102	4570	71	62
v/s Ratio Prot	c0.78			c0.04	0.40	c0.01	
v/s Ratio Perm		0.03					0.00
v/c Ratio	0.96	0.04		0.61	0.44	0.37	0.01
Uniform Delay, d1	13.2	3.1		75.4	1.4	76.7	75.6
Progression Factor	1.00	1.00		1.00	1.00	1.00	1.00
Incremental Delay, d2	6.9	0.0		9.8	0.1	3.2	0.1
Delay (s)	20.1	3.1		85.3	1.5	79.8	75.6
Level of Service	C	A		F	A	E	E
Approach Delay (s)	19.8				4.0	78.2	
Approach LOS	B				A	E	

Intersection Summary

HCM 2000 Control Delay	14.9	HCM 2000 Level of Service	B
HCM 2000 Volume to Capacity ratio	0.91		
Actuated Cycle Length (s)	164.0	Sum of lost time (s)	15.0
Intersection Capacity Utilization	83.8%	ICU Level of Service	E
Analysis Period (min)	15		

c Critical Lane Group

Intersection				
Intersection Delay, s/veh	7.3			
Intersection LOS	A			
Approach	EB	WB	NB	SB
Entry Lanes	0	1	1	1
Conflicting Circle Lanes	1	1	1	1
Adj Approach Flow, veh/h	0	8	495	181
Demand Flow Rate, veh/h	0	8	504	184
Vehicles Circulating, veh/h	257	478	0	103
Vehicles Exiting, veh/h	30	25	257	383
Follow-Up Headway, s	3.186	3.186	3.186	3.186
Ped Vol Crossing Leg, #/h	1	11	0	3
Ped Cap Adj	1.000	0.998	1.000	1.000
Approach Delay, s/veh	0.0	5.3	8.1	5.3
Approach LOS	-	A	A	A
Lane	Left	Left	Left	
Designated Moves	LTR	LTR	LTR	
Assumed Moves	LTR	LTR	LTR	
RT Channelized				
Lane Util	1.000	1.000	1.000	
Critical Headway, s	5.193	5.193	5.193	
Entry Flow, veh/h	8	504	184	
Cap Entry Lane, veh/h	701	1130	1019	
Entry HV Adj Factor	1.000	0.980	0.981	
Flow Entry, veh/h	8	494	181	
Cap Entry, veh/h	700	1108	1000	
V/C Ratio	0.011	0.446	0.181	
Control Delay, s/veh	5.3	8.1	5.3	
LOS	A	A	A	
95th %tile Queue, veh	0	2	1	

HCM Unsignalized Intersection Capacity Analysis
 20: W Hind Dr & School Dwy/Nenue St

11/28/2014



Movement	EBL	EBT	EBR	WBL	WBT	WBR	NBL	NBT	NBR	SBL	SBT	SBR
Lane Configurations		↕			↕			↕			↕	
Volume (veh/h)	21	8	18	3	0	7	25	294	42	9	153	7
Sign Control		Stop			Stop			Free			Free	
Grade		0%			0%			0%			0%	
Peak Hour Factor	0.91	0.91	0.91	0.91	0.91	0.91	0.91	0.91	0.91	0.91	0.91	0.91
Hourly flow rate (vph)	23	9	20	3	0	8	27	323	46	10	168	8
Pedestrians		5										
Lane Width (ft)		12.0										
Walking Speed (ft/s)		4.0										
Percent Blockage		0										
Right turn flare (veh)												
Median type								None			None	
Median storage veh												
Upstream signal (ft)												
pX, platoon unblocked												
vC, conflicting volume	606	621	177	617	602	346	181			369		
vC1, stage 1 conf vol												
vC2, stage 2 conf vol												
vCu, unblocked vol	606	621	177	617	602	346	181			369		
tC, single (s)	*6.1	*5.5	*5.2	*6.1	6.5	*5.2	4.1			4.1		
tC, 2 stage (s)												
tF (s)	3.5	4.0	3.3	3.5	4.0	3.3	2.2			2.2		
p0 queue free %	95	98	98	99	100	99	98			99		
cM capacity (veh/h)	467	466	907	451	400	769	1389			1189		

Direction, Lane #	EB 1	WB 1	NB 1	SB 1
Volume Total	52	11	397	186
Volume Left	23	3	27	10
Volume Right	20	8	46	8
cSH	573	634	1389	1189
Volume to Capacity	0.09	0.02	0.02	0.01
Queue Length 95th (ft)	7	1	2	1
Control Delay (s)	11.9	10.8	0.7	0.5
Lane LOS	B	B	A	A
Approach Delay (s)	11.9	10.8	0.7	0.5
Approach LOS	B	B		

Intersection Summary			
Average Delay		1.7	
Intersection Capacity Utilization		37.3%	ICU Level of Service A
Analysis Period (min)		15	

* User Entered Value